

AC Servo Drives Σ -V Series USER'S MANUAL

CANopen Network Module

SGDV-OCB01A

To properly use the product, read this manual thoroughly and retain for easy reference, inspection and maintenance. Ensure the end user receives this manual.



Please check www.yaskawa.eu.com for up-to-date versions.

Copyright © 2010 YASKAWA ELECTRIC EUROPE GmbH

All rights reserved. No part of this publication may be reproduced, stored in a retrieval system, or transmitted, in any form, or by any means, mechanical, electronic, photocopying, recording, or otherwise, without the prior written permission of Yaskawa. No patent liability is assumed with respect to the use of the information contained herein. Moreover, because Yaskawa is constantly striving to improve its high-quality products, the information contained in this manual is subject to change without notice. Every precaution has been taken in the preparation of this manual. Nevertheless, Yaskawa assumes no responsibility for errors or omissions. Neither is any liability assumed for damages resulting from the use of the information contained in this publication.

About this manual

This manual describes the operation of the SGD V-OCB01A CANopen network module with the S-V Series servo drive. For a more complete understanding of the S-V Series capabilities and features, refer to the related manuals.

Be sure to refer to this manual and perform operations correctly.

Keep this manual in a location where it can be accessed for reference whenever required.

This manual contains the following chapters:

- **Chapter 1:** Introduces the product specification and technical data.
- **Chapter 2:** Describes the installation and configuration of the hardware and communication.
- **Chapters 3 - 5:** Describes the communication, PDOs and SGD V objects.
- **Chapter 6:** Describes the device control.
- **Chapters 7 - 13:** Describes the motion related objects in various modes of operation and the profile motion parameters.
- **Chapter 14:** I/O: Describes how to read and set analog or digital inputs/ outputs.
- **Chapter 15:** Describes error messages and error handling.
- **Chapter 16:** Provides examples.
- **Chapter 17:** Describes the data types.
- **Chapter 18:** Lists the SGD V-OCB01A objects based on EDS.

■ IMPORTANT explanations

The following icon is displayed for explanations requiring special attention.



- Indicates important information that should be memorized, as well as precautions, such as alarm displays, that do not involve potential damage to equipment.

■ Notation used in this manual

In this manual, the names of reverse signals (ones that are valid when low) are written with a forward slash (/) before the signal name, as shown in the following example:

Example

$$\overline{S-ON} = /S-ON$$

■ Manuals related to the Sigma-5 series

Refer to the following manuals as required.

Name	Selecting Models and Peripheral Devices	Ratings and Specifications	System Design	Panels and Wiring	Trial Operation	Trial Operation and Servo Adjustment	Maintenance and Inspection
Σ-V Series User's Manual Setup Rotational Motor (SIEPS800000 43)	✓	✓		✓	✓		
Σ-V Series User's Manual Design and Maintenance Rotational Motor/ Analog Voltage and Pulse Train Reference (SIEPS800000 45)		✓	✓	✓		✓	✓

■ Safety information

The following conventions are used to indicate precautions in this manual. Failure to heed precautions provided in this manual can result in serious or possibly even fatal injury or damage to the products or to related equipment and systems.



Indicates precautions that, if not heeded, could possibly result in loss of life or serious injury.



Indicates precautions that, if not heeded, could result in relatively serious or minor injury, damage to the product, or faulty operation.

In some situations, the precautions indicated could have serious consequences if not heeded.



Indicates prohibited actions that must not be performed. For example, this symbol would be used to indicate that fire is prohibited as follows:



Indicates compulsory actions that must be performed. For example, this symbol would be used as follows to indicate that grounding is compulsory:



Safety precautions

These safety precautions are very important. Read them before performing any procedures such as checking products on delivery, storage and transportation, installation, wiring, operation and inspection, or disposal. Be sure to always observe these precautions thoroughly.

WARNING

- Never touch any rotating motor parts while the motor is running.
Failure to observe this warning may result in injury.
- Before starting operation with a machine connected, make sure that an emergency stop can be applied at any time.
Failure to observe this warning may result in injury or damage to the product.
- Never touch the inside of the SERVOPACKs.
Failure to observe this warning may result in electric shock.
- Do not remove the cover of the power supply terminals while the power is ON.
Failure to observe this warning may result in electric shock.
- After the power is turned OFF or after a voltage resistance test, do not touch terminals while the CHARGE lamp is ON.
Residual voltage may cause electric shock.
- Follow the procedures and instructions provided in this manual for trial operation.
Failure to do so may result not only in faulty operation and damage to equipment, but also in personal injury.
- The multi-turn output range for the S-V Series absolute position detecting system is different from that of earlier systems (15-bit and 12-bit encoders). In particular, change the system to configure the S series infinite-length positioning system with the S-V Series.
- The multi-turn limit value needs not be changed except for special applications.
Changing it inappropriately or unintentionally can be dangerous.
- If the Multi-turn Limit Disagreement alarm occurs, check the setting of parameter Pn205 in the SERVOPACK to be sure that it is correct.
If Fn013 is executed when an incorrect value is set in Pn205, an incorrect value will be set in the encoder. The alarm will disappear even if an incorrect value is set, but incorrect positions will be detected, resulting in a dangerous situation where the machine will move to unexpected positions.
- Do not remove the front cover, cables, connectors, or optional items from the upper front of the SERVOPACK while the power is ON.
Failure to observe this warning may result in electric shock.
- Do not damage, press, exert excessive force on, or place heavy objects on the cables.
Failure to observe this warning may result in electric shock, stopping operation of the product, or fire.
- Do not modify the product.
Failure to observe this warning may result in injury, fire, or damage to the product.

WARNING

- Provide an appropriate stopping device on the machine side to ensure safety. The holding brake on a servomotor with a brake is not a stopping device for ensuring safety.
Failure to observe this warning may result in injury.
- Do not come close to the machine immediately after resetting a momentary power loss. The machine may restart unexpectedly. Take appropriate measures to ensure safety against an unexpected restart.
Failure to observe this warning may result in injury.
-  • Connect the ground terminal according to local electrical codes (100 W or less for a SERVOPACK with a 100, 200 V power supply. 10 W or less for a SERVOPACK with a 400 V power supply.)
Improper grounding may result in electric shock or fire.
-  • Installation, disassembly, or repair must be performed only by authorized personnel.
Failure to observe this warning may result in electric shock or injury.
- The person who designs a system using the safety function (Hard Wire Baseblock function) must have full knowledge of the related safety standards and full understanding of the instructions in *S-V Series User's Manual Design and Maintenance* (SIEP S800000 45/46).
Failure to observe this warning may result in injury or damage to the product.

■ Storage and transportation

CAUTION

- Do not store or install the product in the following locations.
Failure to observe this caution may result in fire, electric shock, or damage to the product.
 - Locations subject to direct sunlight
 - Locations subject to temperatures outside the range specified in the storage/installation temperature conditions
 - Locations subject to humidity outside the range specified in the storage/installation humidity conditions
 - Locations subject to condensation as the result of extreme changes in temperature
 - Locations subject to corrosive or flammable gases
 - Locations subject to dust, salts, or iron dust
 - Locations subject to exposure to water, oil, or chemicals
 - Locations subject to shock or vibration
- Do not hold the product by the cables, motor shaft or detector while transporting it.
Failure to observe this caution may result in injury or malfunction.
- Do not place any load exceeding the limit specified on the packing box.
Failure to observe this caution may result in injury or malfunction.

■ Storage and transportation (cont'd)

CAUTION

- If disinfectants or insecticides must be used to treat packing materials such as wooden frames, pallets, or plywood, the packing materials must be treated before the product is packaged, and methods other than fumigation must be used.
- Example: Heat treatment, where materials are kiln-dried to a core temperature of 56 °C for 30 minutes or more.
If the electronic products, which include stand-alone products and products installed in machines, are packed with fumigated wooden materials, the electrical components may be greatly damaged by the gases or fumes resulting from the fumigation process. In particular, disinfectants containing halogen, which includes chlorine, fluorine, bromine, or iodine can contribute to the erosion of the capacitors.

■ Installation

CAUTION

- Never use the product in an environment subject to water, corrosive gases, inflammable gases, or combustibles.
Failure to observe this caution may result in electric shock or fire.
- Do not step on or place a heavy object on the product.
Failure to observe this caution may result in injury.
- Do not cover the inlet or outlet ports and prevent any foreign objects from entering the product.
Failure to observe this caution may cause internal elements to deteriorate resulting in malfunction or fire.
- Be sure to install the product in the correct direction.
Failure to observe this caution may result in malfunction.
- Provide the specified clearances between the SERVOPACK and the control panel or with other devices.
Failure to observe this caution may result in fire or malfunction.
- Do not apply any strong impact.
Failure to observe this caution may result in malfunction.

■ Wiring

CAUTION

- Be sure to wire correctly and securely.
Failure to observe this caution may result in motor overrun, injury, or malfunction.
- Do not connect a commercial power supply to the U, V, or W terminals for the servomotor connection.
Failure to observe this caution may result in injury or fire.
- Securely connect the main circuit power supply terminals and servomotor connection terminals.
Failure to observe this caution may result in fire.
- Do not bundle or run the main circuit cables together with the I/O signal cables or the encoder cables in the same duct. Keep them separated by at least 30 cm.
Failure to do so may result in malfunction.
- Use shielded twisted-pair wires or multi-core shielded twisted-pair wires for I/O signal cables and the encoder cables.
- I/O signal cables must be no longer than 3 m, encoder cables must be no longer than 50 m, and control power supply (+24 V, 0 V) cables for a 400 V input SERVOPACK must be no longer than 10 m.
- Do not touch the power terminals while the CHARGE lamp is ON after turning power OFF because high voltage may still remain in the SERVOPACK.
Make sure the charge indicator is off first before starting an inspection.
- Observe the following precautions when wiring main circuit terminals.
 - Remove detachable main circuit terminals from the SERVOPACK prior to wiring.
 - Insert only one main circuit cable per opening in the main circuit terminals.
 - Make sure that no part of the core wire comes into contact with (i.e., short-circuit) adjacent wires.
- Install a battery at either the host controller or the battery unit of the encoder, but not both.
It is dangerous to install batteries at both ends simultaneously, because that sets up a loop circuit between the batteries.
- Always use the specified power supply voltage.
An incorrect voltage may result in fire or malfunction.
- Take appropriate measures to ensure that the input power supply is supplied within the specified voltage fluctuation range. Be particularly careful in places where the power supply is unstable.
An incorrect power supply may result in damage to the product.
- Install external breakers or other safety devices against short-circuiting in external wiring.
Failure to observe this caution may result in fire.
- Take appropriate and sufficient countermeasures for each form of potential interference when installing systems in the following locations.
 - Locations subject to static electricity or other forms of noise
 - Locations subject to strong electromagnetic fields and magnetic fields
 - Locations subject to possible exposure to radioactivity
 - Locations close to power suppliesFailure to observe this caution may result in damage to the product.

■ Wiring (cont'd)

CAUTION

- Do not reverse the polarity of the battery when connecting it. Failure to observe this caution may result in damage to the battery, the SERVOPACK, or cause an explosion.
- Wiring or inspection must be performed by a technical expert.
- Use a 24 VDC power supply with double insulation or reinforced insulation.

■ Operation

CAUTION

- Conduct trial operations on the servomotor alone, with the motor shaft disconnected from the machine to avoid accidents. Failure to observe this caution may result in injury.
- Before starting operation with a machine connected, change the settings to match the parameters of the machine. Starting operation without matching the proper settings may cause the machine to run out of control or malfunction.
- Do not frequently turn power ON and OFF. Since the SERVOPACK has a capacitor in the power supply, a high charging current flows when power is turned ON. Frequently turning power ON and OFF causes main power devices like capacitors and fuses to deteriorate, resulting in unexpected problems.
- When using JOG operations (Fn002) origin search operations (Fn003), or EasyFFT operations (Fn206), the dynamic brake function does not work for reverse overtravel or forward overtravel. Take necessary precautions. Failure to observe this caution may result in damage to the product.
- When using the servomotor for a vertical axis, install safety devices to prevent workpieces from falling due to alarms or overtravels. Set the servomotor so that it will stop in the zero clamp state when overtravel occurs. Failure to observe this caution may cause workpieces to fall due to overtravel.
- When not using tuning-less function, set to the correct moment of inertia ratio (Pn103). Setting to an incorrect moment of inertia ratio may cause vibration.
- Do not touch the SERVOPACK heatsinks, regenerative resistor, or servomotor while power is ON or soon after the power is turned OFF. Failure to observe this caution may result in burns due to high temperatures.
- Do not make any extreme adjustments or setting changes of parameters. Failure to observe this caution may result in injury or damage to the product due to unstable operation.
- When an alarm occurs, remove the cause, reset the alarm after confirming safety, and then resume operation. Failure to observe this caution may result in damage to the product, fire, or injury.
- Do not use the holding brake of the servomotor for braking. Failure to observe this caution may result in malfunction.

■ Operation (cont'd)

CAUTION

- Always use the servomotor and SERVOPACK in one of the specified combinations.
Failure to observe this caution may result in fire or malfunction.
- The servomotor stopping method of turning the main-circuit or control-circuit power OFF without turning the servo OFF during operation can not be set in Parameter Pn001. Use the following method to stop the servomotor.
 - When turning the main-circuit power OFF without turning the servo OFF:
The servomotor will be stopped by dynamic braking (DB).
 - When turning the control-circuit power OFF without turning the servo OFF:
The stopping method will vary depending on the SERVOPACK model.
Refer to the Σ -V Series User's Manual Design and Maintenance for details.

■ Maintenance and inspection

CAUTION

- Do not disassemble the SERVOPACK.
Failure to observe this caution may result in electric shock or injury.
- Do not attempt to change wiring while the power is ON.
Failure to observe this caution may result in electric shock or injury.
- When replacing the SERVOPACK, resume operation only after copying the previous SERVOPACK parameters to the new SERVOPACK.
Failure to observe this caution may result in damage to the product.

■ Disposal

CAUTION

- When disposing of the products, treat them as ordinary industrial waste.

■ General precautions

Observe the following general precautions to ensure safe application.

- The products shown in illustrations in this manual are sometimes shown without covers or protective guards. Always replace the cover or protective guard as specified first, and then operate the products in accordance with the manual.
- The drawings presented in this manual are typical examples and may not match the product you received.
- This manual is subject to change due to product improvement, specification modification, and manual improvement. When this manual is revised, the manual code is updated and the new manual is published as a next edition. The edition number appears on the front and back covers.
- If the manual must be ordered due to loss or damage, inform your nearest Yaskawa representative or one of the offices listed on the back of this manual.
- Yaskawa will not take responsibility for the results of unauthorized modifications of this product.
Yaskawa shall not be liable for any damages or troubles resulting from unauthorized modification.

CONTENTS

About this manual	iii
Safety precautions	vi
1 SGDV-OCB01A CANopen Network Module	1-1
1.1 Introduction	1-1
1.2 CANopen network module features	1-1
1.3 SGDV-OCB01A Model designation	1-2
1.4 SGDV-OCB01A Technical specifications	1-3
1.5 Checking on delivery	1-4
1.5.1 Checking items	1-4
1.5.2 Nameplate	1-4
1.6 SGDV-OCB01A Hardware interface	1-5
1.6.1 RUN LED status description	1-5
1.6.2 ERROR LED status description	1-6
1.6.3 S1 and S2 – Address switches	1-6
1.6.4 S3 - Baud rate selection switch	1-7
1.6.5 CAN connector	1-7
1.6.6 CANopen cable	1-8
1.6.7 Termination resistor	1-8
1.6.8 SGDV-OCB01A Dimensions	1-8
2 Hardware installation	2-1
2.1 Mounting the CANopen network module	2-1
2.2 Connecting to the CAN bus network	2-2
3 Communication parameter objects	3-1
3.1 Object 1000h - Device Type	3-1
3.2 Object 1001h - Error Register	3-1
3.3 Object 1005h - COB-ID SYNC	3-1
3.4 Object 1008h - Manufacturer Device Name	3-2
3.5 Object 1010h - Store Parameters	3-2
3.6 Object 1011h - Restore Default Parameters	3-3
3.7 Object 1014h - COB-ID EMCY	3-4
3.8 Object 1016h - Consumer Heartbeat Time	3-4
3.9 Object 1017h - Producer Heartbeat Time	3-5
3.10 Object 1018h - Identity Object	3-6

4	Process Data Objects (PDOs)	4-1
4.1	PDO objects overview	4-1
4.2	Object 1400h-1403h - RPDO Communication Parameter	4-1
4.3	Object 1600h-1603h - RPDO Mapping Parameter	4-3
4.3.1	Default values for RPDO	4-4
4.4	Object 1800h-1803h - TPDO Communication Parameter	4-6
4.5	Object 1A00h-1A03h - TPDO Mapping Parameter	4-8
4.5.1	Default values for TPDO	4-9
4.6	Mapping procedure	4-11
5	Manufacturer specific objects	5-1
5.1	Object 2004h - Utility servo function	5-1
5.2	Object 203fh - Manufacturer error code	5-1
5.3	Object 2100h - Get Parameter	5-2
5.4	Object 2101h - Set Parameter	5-2
5.5	Object 2211h - Read Monitor	5-3
5.6	Object 2300h - User unit group enable	5-3
5.7	Object 2301h - Position User Unit	5-3
5.8	Object 2302h - Velocity User Unit	5-4
5.9	Object 2303h - Acceleration User Unit	5-4
5.10	Object 2400h - Position Range Limit Designation	5-8
5.11	Object 2401h - Target_Position_In_Range	5-8
5.12	Object 2402h - Actual_Position_In_Range	5-8
6	Device control objects	6-1
6.1	SGDV-OCB01A Device control - General	6-1
6.1.1	CAN network management (NMT)	6-1
6.1.2	Controlling the Power Drive System (PDS)	6-2
6.1.3	Modes of operation	6-4
6.2	Object 603fh – Error code	6-4
6.3	Object 6040h – Control Word	6-4
6.4	Object 6041h – Status Word	6-5
6.5	Object 6060h - Modes of Operation	6-6
6.6	Object 6061h - Modes of Operation Display	6-7
7	Pole detection mode	7-1
7.1	Introduction	7-1
7.2	Mode of operation (6060h)	7-1

7.3	Control word (6040h)	7-1
7.4	Status word (6041h)	7-1
7.5	Pole detection condition	7-2
8	Profile position objects	8-1
8.1	Mode specific control word	8-1
8.2	Mode specific status word	8-1
8.3	Object 6067h - Position Window	8-2
8.4	Object 6068h - Position Window Time	8-2
8.5	Object 607Fh - Maximum Profile Velocity	8-3
8.6	Object 6081h - Profile Velocity	8-3
8.7	Object 6083h - Profile Acceleration	8-3
8.8	Object 6084h - Profile Deceleration	8-3
8.9	Object 6085h - Quick Stop Deceleration	8-4
8.10	Object 607Ah - Target Position	8-4
8.11	Object 6062h – Position Demand Value in User Units	8-4
8.12	Object 6063h – Position Actual Value	8-5
8.13	Object 6064h – Position Actual Value in User Units	8-5
9	Homing mode objects	9-1
9.1	Mode specific control word	9-1
9.2	Mode specific status word	9-1
9.3	Object 607Ch – Home Offset	9-2
9.4	Object 6098h - Homing Method	9-2
9.5	Object 6099h - Homing Speed	9-9
9.6	Object 609Ah - Homing Acceleration	9-9
10	Profile velocity mode objects	10-1
10.1	Mode specific control word	10-1
10.2	Mode specific status word	10-1
10.3	Object 606Bh - Velocity Demand Value	10-1
10.4	Object 606Ch - Velocity Actual Value	10-2
10.5	Object 60FFh - Target Velocity	10-2
10.6	Object 6083h - Profile Acceleration	10-2
10.7	Object 6084h - Profile Deceleration	10-3
10.8	Object 6085h - Quick Stop Deceleration	10-3

11 Profile torque mode objects	11-1
11.1 Mode specific control word	11-1
11.2 Mode specific status word	11-1
11.3 Object 6071h - Target Torque	11-1
11.4 Object 6072h - Maximum Torque	11-2
11.5 Object 6074h - Torque Demand	11-2
11.6 Object 6077h - Torque Actual Value	11-2
11.7 Object 6087h - Torque Slope	11-2
12 Touch probe	12-1
12.1 Object 60B8h - Touch probe function	12-1
12.2 Object 60B9h - Touch probe status	12-2
12.3 Object 60BAh - Touch probe pos1 pos value	12-2
12.4 Object 60BCh - Touch probe pos2 pos value	12-3
13 Interpolated position mode	13-1
13.1 General information	13-1
13.2 Mode specific control word	13-3
13.3 Mode specific status word	13-3
13.4 Object 60C1h - Interpolation Data Record	13-3
13.5 Object 60C2h - Interpolation Time Period	13-4
13.6 Guidelines for interpolated motion execution	13-4
13.6.1 Working in continuous execution:	13-4
14 Inputs and outputs objects	14-1
14.1 Object 60FDh - Digital Inputs	14-1
14.2 Object 60FEh - Digital Output	14-1
15 Error handling	15-1
15.1 General	15-1
15.2 Classes	15-1
15.3 EMCY message format	15-1
15.4 Generic error	15-2
15.5 CANopen communication errors	15-2
15.6 Emergency message	15-3
15.7 Error code chart	15-4

15.7.1	Error code chart 1: Errors detected by the CANopen network card	15-6
15.7.2	Error code chart 2: Errors detected by the servo unit	15-7
15.7.3	Abort SDO Transfer Protocol	15-9
15.7.4	Recovery procedure after the interlock circuit is open:	15-10
16	Examples	16-1
16.1	Homing example	16-1
16.2	Profile position example	16-2
17	Description of data types	17-1
17.1	Data types	17-1
18	SGDV-OCB01A objects based on EDS	18-1
18.1	Description of objects	18-1

Revision History

1 SGD V-OCB01A CANopen Network Module

1.1 Introduction

The SGD V-OCB01A is an add-on board, compatible with Σ -V Series models, which provides an interface for CANopen networking (Network type). The CANopen interface enables the user to achieve high-speed distributed control with a high level of reliability. CANopen is a higher-layer protocol commonly used in automation industry. The specification of this protocol is maintained and developed by the CiA (CAN in Automation) organization (www.can-cia.org).

1.2 CANopen network module features

CANopen network module offers a wide range of functions based on the following:

- CANopen DS-301 specification
- Drive profiles according to DSP-402, V2.0 support the following modes:
 - Pole Detection Mode
 - Profile Position Mode
 - Homing Mode
 - Profile Velocity Mode
 - Profile Torque Mode
 - Interpolated position mode
- Rotary switches for setting node ID – up to 127 nodes
- Communication rate of up to 1 Mbps
- Standard 9-pin D-type connector
- Two indicator LEDs according to CiA303-3

CANopen network module is conform to:

- CiA Specifications
- Safety Standard UL508
- Material Compliance UL94V-0
- RoHS Directive 2002/95/EC
- WEEE Directive 2002/96/EC
- Low Voltage Directive 73/23/EEC
- EMC Directive 89/336/EEC

1.3 SGD V-OCB01A Model designation

The network module that is mounted onto the servopack consists of the network card and the housing for the network card.

Model designation for the network card

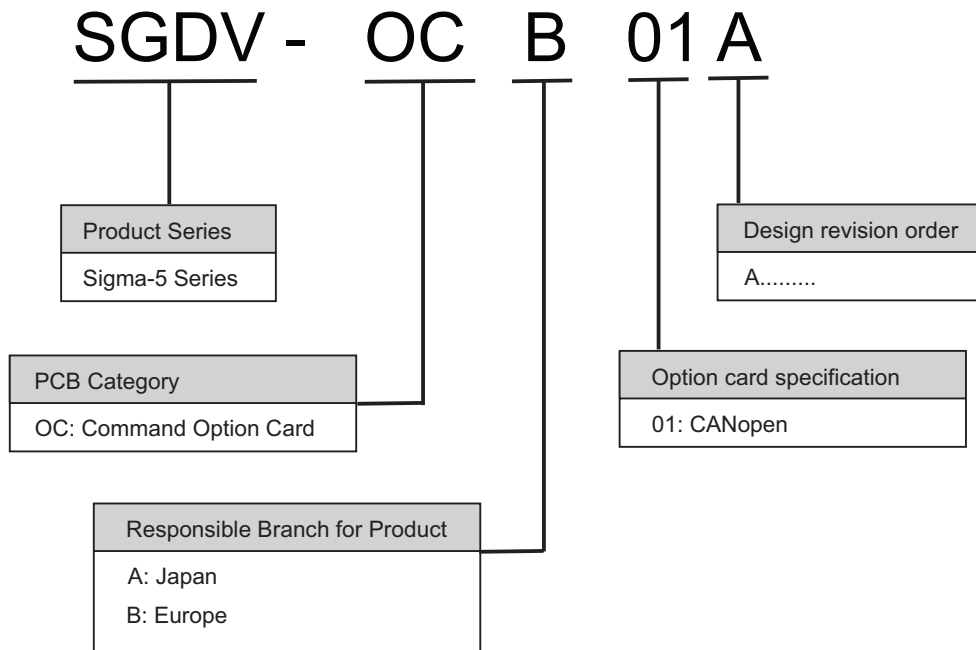

Model designation for the housing

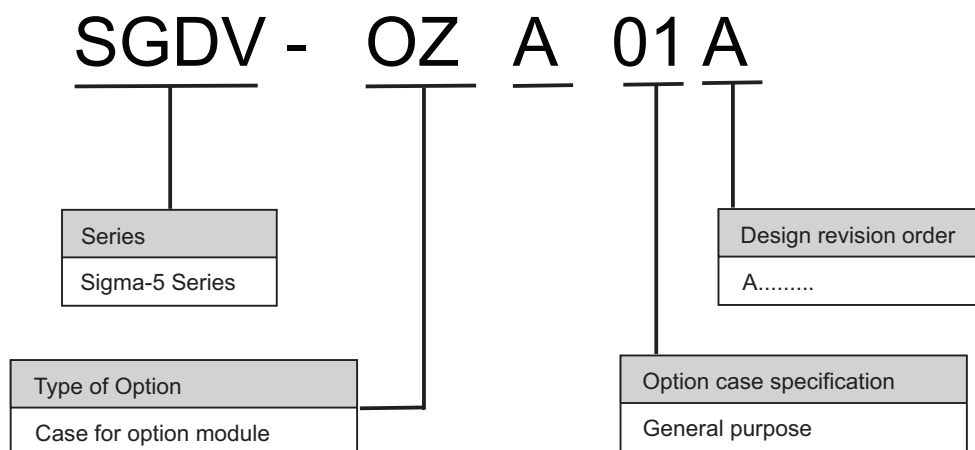

1.4 SGD V-OCB01A Technical specifications

CANopen communication standards	DS-301, V4.02
CAN bit rates	10, 20, 50, 125, 250, 500, 800, 1000 Kbps
CAN identifier	Standard 11 bit
CANopen node-ID	1-127 (set by two rotary switches)
NMT services	Slave
SDO communication	1 server
Block transfer	No
Segmented transfer	Yes
Block transfer	No
PDO communication	Producer and consumer, default setting according to DSP-402
Supported RPDOs	1 to 4
Supported TPDOs	1 to 4
PDO mapping entries	Dynamic with maximum 2 mapping entries
SYNC	Consumer
Time stamp	No
Emergency messages	Producer
Node guarding	No
Heartbeat	Producer and Consumer
Non-volatile storage	Yes
CANopen profile for drives	DSP-402, V2.0
Axis types	Linear and Rotary
Motor type	Brushless AC servo
Storage temperature	-20 to +85 °C
Ambient temperature	0 to +55 °C
Ambient temperature to ensure long-term reliability	+45 °C or less
Ambient humidity	90 % RH or less (non-condensing)
Vibration	4.9 m/s ² or less
Current consumption	0.28 A from 5VDC Servo Drive supply

1.5 Checking on delivery

1.5.1 Checking items

When Σ -V Series products such as network boards are delivered, check the items displayed in the table below.

Check Items	Remarks
Check if the delivered products match the ones you ordered.	Check the types marked on the nameplates of the network unit.
Check for any visible damage.	Check the overall appearance, and check for damage or scratches resulting from transportation.
Check if the type of SGD V is applicable for network unit.	Check the nameplate of the SGD V.

1.5.2 Nameplate

The description and production details of the product are displayed on the network module's nameplate as shown below.

SERVOPACK

CANopen Network Module

Model SGD V-OCB01A **VER.:**

O/N _____
S/N XXXXXXXXXXXX







Use with SGD V
SERVOPACK only.



YASKAWA ELECTRIC EUROPE GMBH
 MADE IN JAPAN

Serial Number

1.6 SGDV-OCB01A Hardware interface

The table below describes the elements of the SGDV-OCB01A hardware interface as displayed in the figure on the right side of the table.

No.	Name	Description	Appearance
1	RUN LED	Indicates the status of the CANopen network state machine.	
2	ERROR LED	Indicates the status of the CAN physical layer and indicates errors due to missing CAN messages.	
3	S1: Address Switch	Sets the most significant bit of the CAN node address (hexadecimal format). (See 1.6.3 S1 and S2 – Address switches.)	
4	S2: Address Switch	Sets the least significant bit of the CAN node address (hexadecimal format). (See 1.6.3 S1 and S2 – Address switches.)	
5	S3: Baud Rate Selection Switch	Sets the baud rate using the DIP switch S3.	
6	CN11 connector	D-SUB 9-Pin Plug CAN Bus Connector	
7	CN12 connector	14-Pin high density Serial Port connector	

1.6.1 RUN LED status description

The RUN LED indicates the status of the CANopen Network Management (NMT) state of machine. (For more details about the NMT see Section 6.1.1.)

Table 3 describes the RUN LED states:

No.	LED state	NMT state	Description
1	Single flash	Stopped	SGDV-OCB01A is in stopped state.
2	Blinking	Preoperational	SGDV-OCB01A is in preoperational state.
3	Light ON	Operational	SGDV-OCB01A is in operational state.

1.6.2 ERROR LED status description

The Error LED indicates the status of the CAN physical layer. It also indicates errors due to missing CAN messages.

No.	LED State	Device state	Description
1	OFF	No error	SGDV-OCB01A is in working condition.
2	SINGLE FLASH	Warning Limit Reached	At least one of the error counters of the CAN controller has reached or exceeded the warning limit.
3	DOUBLE FLASH	Error Control Event	A guard event (NMT) or a heartbeat event has occurred.
4	TRIPLE FLASH	Sync Error	The SYNC message has not been received within the configured communication cycle period time out. (See index 0x1006.)
5	ON	Bus Off	The CAN controller bus is off.

1.6.3 S1 and S2 – Address switches

Each CAN device should be assigned with a unique identification number.

The identification number is referred to as the **Node-ID**. The Node-ID range is from 1 to 127.

The SGDV-OCB01A has two hexadecimal rotary switches for setting the Node ID.

The Node-ID is a combination of two hexadecimal digits.

The following table shows a few examples:

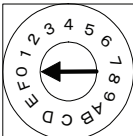
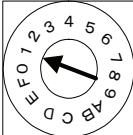
Decimal Address	Switch S1	Switch S2	Hexadecimal Value	Appearance
01	0	1	01	 S1
58	3	A	3A	 S2
127	7	F	7F	

Either the device must be powered on, or the application or communication must be reset for the newly set address to become effective.

The factory default setting for the Node ID is 1.

CAUTION



Set the board address using the rotary switches before applying the power. Exceeding the Node-ID range (1 to 127) causes a malfunction of the CANopen Network Module and consequently disables the RUN LED and the ERROR LED (LED state = OFF).

1.6.4 S3 - Baud rate selection switch

The SGDVB-OCB01A can communicate using several baud rates, and up to 1Mbps. The SGDVB-OCB01A baud rate is set by the DIP switch S3 as defined in the table below.

1	2	3	Baud Rate	Max BUS Length [m]	
ON	ON	ON	10 kbps		<p>DIP-SW: S3</p>
ON	ON	OFF	20 kbps	2500	
ON	OFF	ON	50 kbps	1000	
ON	OFF	OFF	125 kbps	500	
OFF	ON	ON	250 kbps	250	
OFF	ON	OFF	500 kbps	100	
OFF	OFF	ON	800 kbps	50	
OFF	OFF	OFF	1000 kbps	25	

It may be necessary to use repeaters for bus lengths greater than 1000 m. Do not change the setting of switch 4!

1.6.5 CAN connector

The SGDVB-OCB01A is connected to the CAN Bus with the CN11 connector. Connector type: D-type, 9 pin, male.

Terminal Layout

Pin No.	Name
1	NC
2	CAN-L
3	GND
4	NC
5	NC
6	NC
7	CAN-H
8	NC
9	NC
Shield	Connected to CAN cable shield

Recommended mating connector

Connector Parts	
Connector	9-Pin D-SUB for cable, Female
Cover	17JE-09-H1C (DDK)

1.6.6 CANopen cable

CANopen cable has a single twisted pair with overall shielding. CANopen has a specified colour code, and it is strongly recommended that this code is maintained.

Since CANopen networks run at high data rates, they require cable specifically designed to carry high frequency signals. Low quality cable will attenuate the signals, and may render the signal unreadable for the other nodes on the network.

We can only guarantee correct and reliable operation if all other equipment installed on the CANopen network (including the network cable) has been approved by CAN in Automation (CiA).

1.6.7 Termination resistor

The CAN bus network uses two bi-directional signal wires for differential data transmission. The CAN network requires the first and the last nodes to be terminated with a 120 Ω resistor.

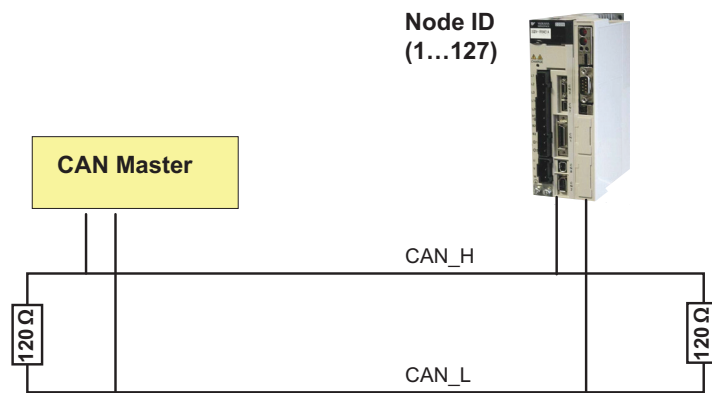

1.6.8 SGD V-OCB01A Dimensions

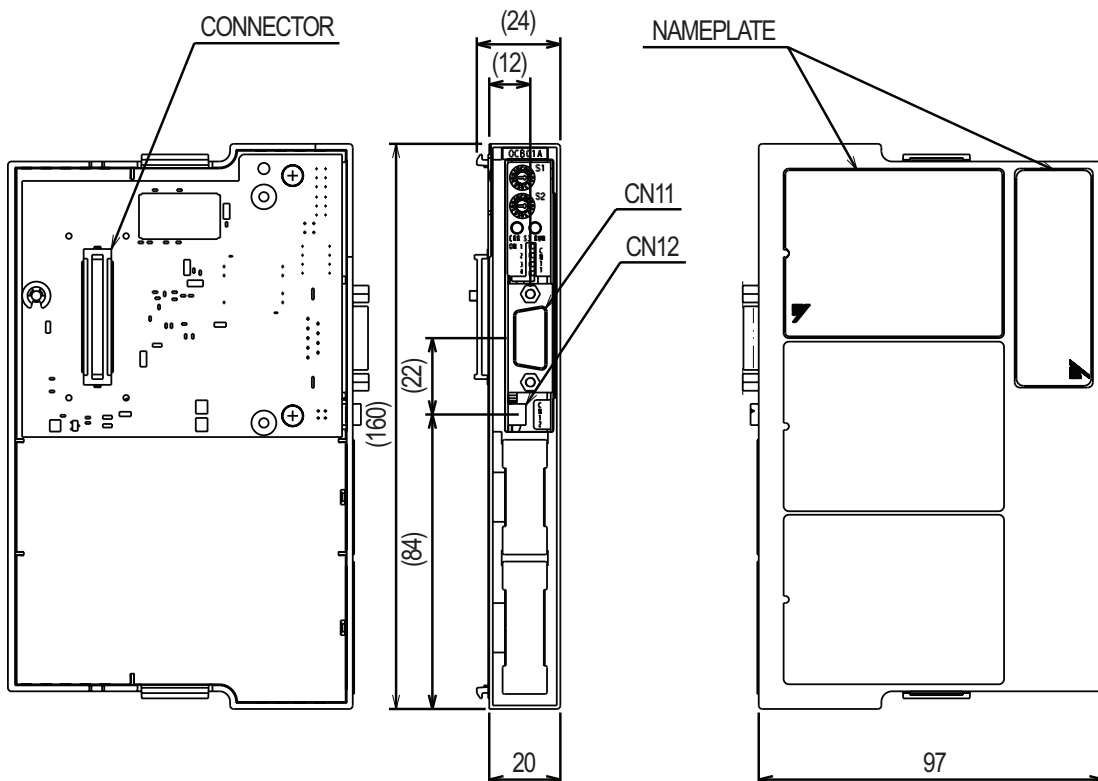

2 Hardware installation

2.1 Mounting the CANopen network module

The CANopen network module will be mounted on the right side of the Sigma-V servopack. To mount the network module to the servopack follow the instructions below.

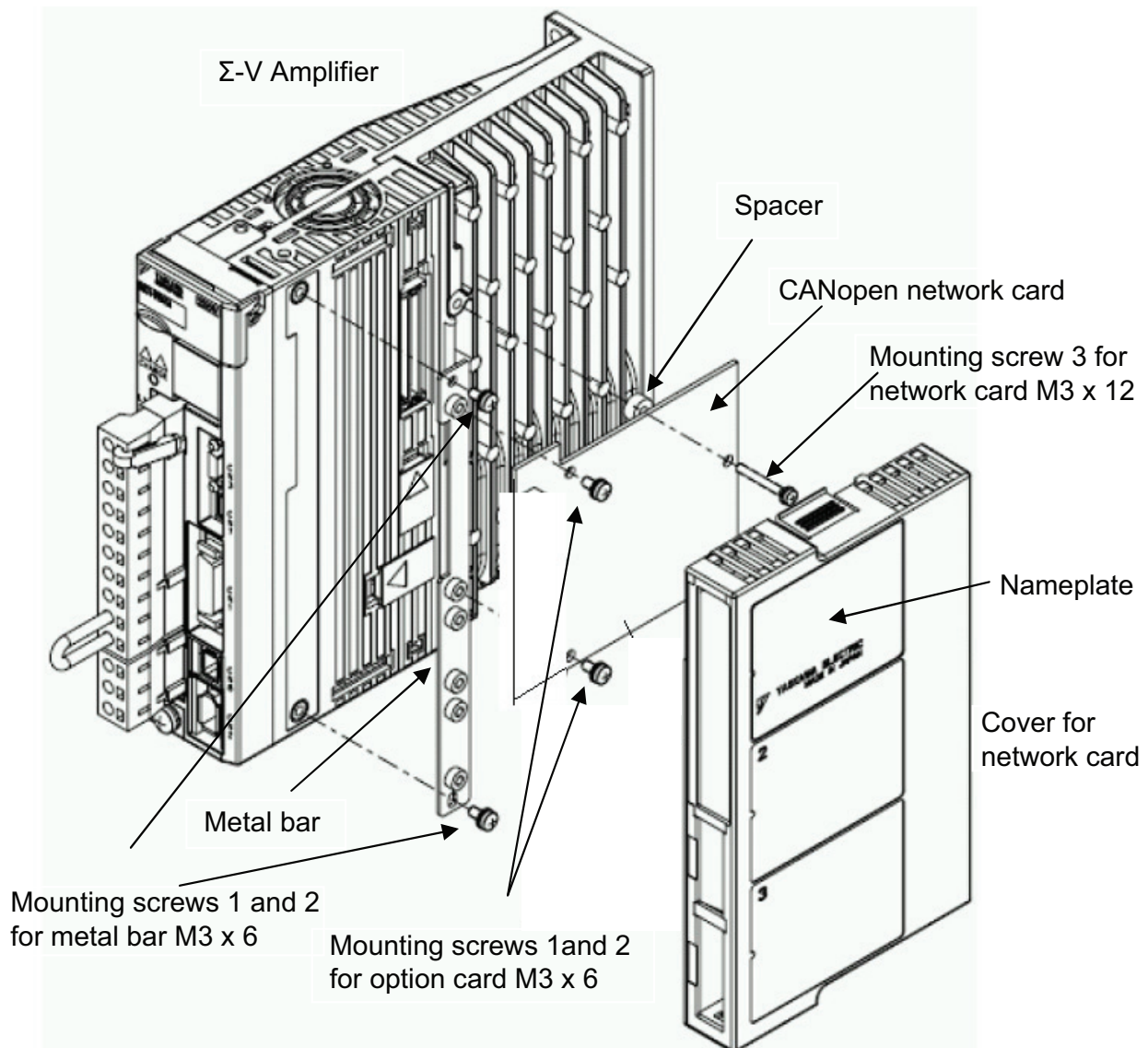

1. Remove the cover from CN10 on the SGD servo amplifier.
2. Mount the metal bar which is delivered with the network module to the SGD servo amplifier with the screws 1 and 2 at both ends of the bar.
3. Now plug in the CANopen network card to CN10.
4. Attach the network card with the screws 1, 2 and 3 to the servo amplifier, do not forget the spacer for screw 3.
5. Now snap on the cover for the network module to the servo amplifier, the completed unit will look like the following picture.



2.2 Connecting to the CAN bus network

Connect the CAN cable to CN6 connector. (See Section 1.6.5 *CAN connector* for the connector layout.)

3 Communication parameter objects

3.1 Object 1000h - Device Type

Index	Sub Index	Parameter Name	Data Type	Access Type	Default Value	Category	PDO Mapping
1000h	0h	Device Type	u32	RO	0x00420192	Mandatory	No

3.2 Object 1001h - Error Register

Index	Sub Index	Parameter Name	Data Type	Access Type	Default Value	Category	PDO Mapping
1001h	0h	Error register	u8	RO		Mandatory	optional

The object shell provides error information. It is part of the emergency object.

Value range

Bit	Value	Function
0	0	No error
	1	Generic error
1-7		Reserved (not supported)

The error message and the error code are triggered by an EMCY object.

3.3 Object 1005h - COB-ID SYNC

Index	Sub Index	Parameter Name	Data Type	Access Type	Default Value	Category	PDO Mapping
1005h	0h	COB-ID-SYNC	u32	RW		Mandatory	No

This object indicates the configured COB-ID frame message for the synchronization object and whatever this device will generate through synchronization. The structure of the object is as follows:

31	30	29	28	11	10	1
X	SYNC generate	0b	000 000 000 000 00b		11bit CAN-ID	

Value range

Bit	Value	Function
0-10		11bit CAN-ID
11-28		29bit CAN-ID (extended)
29	0	Always 0
30	0	Device does not generate SYNC message
	1	Device generates SYNC message
31		Not for use

3.4 Object 1008h - Manufacturer Device Name

Index	Sub Index	Parameter Name	Data Type	Access Type	Default Value	Category	PDO Mapping
1008h	0h	Manufacturer device name	Visible string	RO	SGDV-OCB01A	Optional	No

3.5 Object 1010h - Store Parameters

Index	Sub Index	Parameter Name	Data Type	Access Type	Default Value	Category	PDO Mapping
1010h		Store parameter field	u32			Optional	
	0h	Largest subindex supported	u8	RO		Mandatory	No
	1h	Save all Parameters	u32	RW		Mandatory	No

Writing access

In order to avoid erroneous storage of parameters, they are only stored when a specific signature is written to the appropriate sub-index.

The signature that is written is **save** (ASCII values).

MSB		LSB	
e	v	a	s
65h	76h	61h	73h

Reading access

On reading the appropriate sub-index, CANopen provides information about the storage functionality in the following format:

Storage functionality			
MSB		LSB	
31	2	1	0
00 0000 0000 0000 0000 0000 0000 0000		Auto	Cmd

Reading Message interpretation

Bit	Value	Function
0	0	CANopen device does not save parameters on command.
	1	CANopen device saves parameters on command.
1	0	CANopen device does not save parameters autonomously.
	1	CANopen device saves parameters autonomously.

On receipt of a correct **save** signature to the appropriate sub-index, CANopen stores the parameters to the device and the device generates an SDO for confirmation.

- If the storage process fails, CANopen responds with SDO abort code 06060000h.
- If an incorrect signature is sent, CANopen responds with SDO abort code 08000020h.

3.6 Object 1011h - Restore Default Parameters

Index	Sub Index	Parameter Name	Data Type	Access Type	Default Value	Category	PDO Mapping
1011h		Restore Default Parameter	u32			Optional	
	0h	Largest subindex supported	u8	RO		Mandatory	No
	1h	Restore all Parameters	u32	RW		Mandatory	No

Writing access

In order to avoid erroneous storage of parameters, they are only stored when a specific signature is written to the appropriate sub-index.

The signature that is written is **load** (ASCII values):

MSB		LSB	
d	a	o	l
64h	61h	6Fh	6Ch

Reading access

When the appropriate sub-index is read, CANopen provides information about the storage functionality in the following format:

Storage Functionality			
MSB		LSB	
31	2	1	0
00 0000 0000 0000 0000 0000 0000 0000		Auto	Cmd

Meaning

Bit	Value	Function
0	0	CANopen device does not restore default parameters on command.
	1	CANopen device restores default parameters on command.

- When a correct *load* signature is received by the appropriate sub-index, CANopen restores the default parameters to the device, and the device generates an SDO for confirmation.
- If the restoration fails, CANopen responds with an SDO abort code 06060000h.
- If an incorrect signature is sent, CANopen responds with an SDO abort code 08000020h.
- The default values are set as valid after the device has been reset or power cycled.

3.7 Object 1014h - COB-ID EMCY

Index	Sub Index	Parameter Name	Data Type	Access Type	Default Value	Category	PDO Mapping
1014h	0h	COB-ID EMCY message	u32	RO	0x80h+Node ID	Mandatory	No

This object indicates the configured COB-ID frame message of the emergency object and whatever EMCY exists in the device.

3.8 Object 1016h - Consumer Heartbeat Time

Index	Sub Index	Parameter Name	Data Type	Access Type	Default Value	Category	PDO Mapping
1016h		Consumer heartbeat time				Optional	No
	0h	Number of Entries	u8	RW		Mandatory	
	1h	Consumer 1 heartbeat time	u32	RW		Optional	

This object indicates the expected consumer heartbeat cycle time. The consumer heartbeat value must be higher than the producer cycle time (Object 1017h), otherwise the consumer will perceive it as communication lost. Monitoring this heartbeat will start after the reception of the first heartbeat. Until it is received, the state of the heartbeat producer is unknown.

Sub-index 0h

Number of supported heartbeat consumers.

Value range:

1h = One consumer.

Sub-index 1h

Contains the definitions for the heartbeat consumer in the following structure:

Structure of the heartbeat consumer

31	24	23	16	15	0
Reserved		Consumer node-ID		Heartbeat time	

Value range:

Consumer node-ID: 1-127.

Heartbeat time:

Requested time cycle in 1 msec units.

If the heartbeat time is zero or the node-ID is out of the above range, then the heartbeat consumer object will not be active.

3.9 Object 1017h - Producer Heartbeat Time

Index	Sub Index	Parameter Name	Data Type	Access Type	Default Value	Category	PDO Mapping
1017h	0h	Producer Heartbeat time	U16	RW	0x0	Mandatory	No

This object defines the Heartbeat cycle time.

The Heartbeat is a cyclic signal that a CAN device sends to the network. The Heartbeat consumer receives this cyclic signal message and it can indicate that the heartbeat producer is working properly.

Value range:

0 = Disable Producer Heartbeat.

1...65535 (1...FFFFh) = Cycle time [msec].

3.10 Object 1018h - Identity Object

Index	Sub Index	Parameter Name	Data Type	Access Type	Default Value	Category	PDO Mapping
1018h		Identity Object				Mandatory	
	0h	Number of Entries	u8	RO	0x4	Mandatory	No
	1h	Vendor ID	u32	RO		Mandatory	No
	2h	Product Code	u32	RO		Optional	No
	3h	Revision Number	u32	RO		Optional	No
	4h	Serial Number	u32	RO		Optional	No

This object provides general identification information for the CANopen device.

4 Process Data Objects (PDOs)

4.1 PDO objects overview

The CANopen protocol allows the user to map objects into Process Data Objects (PDOs) to use these PDOs for real time data transfer.

A PDO message length is up to 8 bytes and an SDO message is 16 bytes. Since the data contained in several SDOs can be configured into one PDO, using PDOs can reduce each message length. This reduces the amount of data transferred, making communication more efficient. PDOs use different Communication Object Identifiers (COB-ID) which give them higher priority over SDOs.

SGDV-OCB01A supports 4 Receive PDOs (RPDO) and 4 Transmit PDOs (TPDO). Each PDO uses two objects, one for mapping configuration and one for communication configuration.

- Mapping configuration defines which objects this PDO will include.
 - Communication configuration defines the PDO communication parameters such as: communication object, PDO active/disable, generating trigger, inhibit time and more.
- The table below describes the objects that relate to the relevant PDOs:

PDO related objects

#	Receive PDO			Transmit PDO		
	COB-ID	Communication object	Mapping object	COB-ID	Communication object	Mapping object
1	200h+Node-IDh	1400h	1600h	180h+Node-IDh	1800h	1a00h
2	300h+Node-IDh	1401h	1601h	280h+Node-IDh	1801h	1a01h
3	400h+Node-IDh	1402h	1602h	380h+Node-IDh	1802h	1a02h
4	500h+Node-IDh	1403h	1603h	480h+Node-IDh	1803h	1a03h

4.2 Object 1400h-1403h - RPDO Communication Parameter

Object 1400h-1403h – RPDO Communication Parameter

Index	Sub Index	Parameter Name	Data Type	Access Type	Default Value	Category	PDO Mapping
1400h-1403h		Receive PDO Communication Parameter 1-4				Mandatory	
	0h	Number of Entries	u8	RO	0x5	Mandatory	No
	1h	COB-ID	u32	RW		Mandatory	No
	2h	Transmission Type	u8	RW		Mandatory	No
	3h	Inhibit Time	u16	RW		Optional	No
	4h	Compatibility Entry	u8	RO		Optional	No
	5h	Event Timer	u16	RW		Optional	No

Sub-index 1h

Contains the COB-ID of the RPDO in the following structure:

Structure of COB-ID of RPDO

31	30	29	28	11	10	1
Valid	1	0	000 000 000 000 00b		11bit CAN-ID	
			29bit CAN-ID			

Bit	Value	Function	
0-10		11bit CAN-ID according to the object	
		Object Number	Default Value
		1400h	200h+Node ID
		1401h	300h+Node ID
		1402h	400h+Node ID
1403h	500h+Node ID		
11-28		29bit CAN-ID (extended)	
29	0	Always 0	
30	1	Always 1	
31	0	PDO enable/valid	
	1	PDO disable/is not valid	

- The validity bit (bit 31) allows the user to enable/disable the PDO.
- While the PDO is valid (bit 31=0), no other bits can be changed.
- In the event that bit 29 is changed or 29bit CAN-ID is sent, CANopen will send SDO abort code 06090030h.

Sub-index 2h

Defines the transmission type. SGD V-OCB01A can generate PDOs using time triggers or event triggers.

Value range:

00h = time driven. The CANopen device will actuate the received data at the next SYNC. The time interval is set to sub-index 03h.

FFh = event driven. PDO can be generated at any time by control word changing (object 6040h). Any other data will generate SDO abort code 06090030h.

Sub-index 3h

Inhibit time. Defines the time interval for the time-driven PDO.

Value range:

0 = disable inhibit time.

0...65535 (1...FFFFh) = time interval in 0,1 msec

While the PDO is valid (bit 31=0 in sub-index 1h) the value can not be changed.

Sub-index 4h

Compatibility entry – reserved.

Any read or write access will generate SDO abort code 06090011h.

Sub-index 5h

Event-timer. Defines the minimum time interval between 2 event-driven PDOs.

Value range:

0 = disable event timer.

0...65535 (1...FFFFh) = time interval in 1msec

4.3 Object 1600h-1603h - RPDO Mapping Parameter

Object 1600h-1603h – RPDO mapping parameter

Index	Sub Index	Parameter Name	Data Type	Access Type	Default Value	Category	PDO Mapping
1600h-1603h		Receive PDO Mapping Parameter 1-4				Mandatory	
	0h	Number of Entries	u8	RW	See Table	Mandatory	No
	1h	Mapping Entry 1	u32	RW	See Table	Mandatory	No
	2h	Mapping Entry 2	u32	RW	See Table	Optional	No
	3h	Mapping Entry 3	u32	RW	See Table	Optional	No
	4h	Mapping Entry 4	u32	RW	See Table	Optional	No
	5h	Mapping Entry 5	u32	RW	See Table	Optional	No
	6h	Mapping Entry 6	u32	RW	See Table	Optional	No
	7h	Mapping Entry 7	u32	RW	See Table	Optional	No
	8h	Mapping Entry 8	u32	RW	See Table	Optional	No

Sub-index 0h

Number of entries. Number of objects mapped in the PDO.

Value range:

0h = disable mapping.

1h = 1 object (at least, mandatory)

2h = 2 objects.

3h = 3 objects.

4h = 4 objects.

5h = 5 objects.

6h = 6 objects.

7h = 7 objects.

8h = 8 objects (max).

Sub-index 1h to 8h

Application object.

Value range:

31	16	15	8	7	0
Object Index		Sub-Index		Length	

The length is the number of bits in hex format. (For example - Length of Object with data type u32 is 20h; length of object with data type i16 is 10h)

4.3.1 Default values for RPDO

Object 1600h - RPDO 1 Mapping		Value	Description	Function
Sub-index 0h	Number of objects	1		
Sub-index 1h	Mapping 1 st object	60400010h	Object 6040h, sub-index 0, u16	Control Word
Sub-index 2h	Mapping 2 nd object	-	-	
Sub-index 3h	Mapping 3 rd object	-	-	
Sub-index 4h	Mapping 4 th object	-	-	
Sub-index 5h	Mapping 5 th object	-	-	
Sub-index 6h	Mapping 6 th object	-	-	
Sub-index 7h	Mapping 7 th object	-	-	
Sub-index 0h	Number of objects	1		

Object 1601h - RPDO 2 Mapping		Value	Description	Function
Sub-index 0h	Number of objects	2		
Sub-index 1h	Mapping 1 st object	60400010h	Object 6040h sub-index 0, u16	Control Word
Sub-index 2h	Mapping 2 nd object	607a0020h	Object 607ah sub-index 0, i32	Target Position
Sub-index 3h	Mapping 3 rd object			
Sub-index 4h	Mapping 4 th object			
Sub-index 5h	Mapping 5 th object			
Sub-index 6h	Mapping 6 th object			
Sub-index 7h	Mapping 7 th object			
Sub-index 8h	Mapping 8 th object			

Object 1602h - RPDO 3 Mapping		Value	Description	Function
Sub-index 0h	Number of objects	2		
Sub-index 1h	Mapping 1 st object	60400010h	Object 6040h sub-index 0, u16	Control Word
Sub-index 2h	Mapping 2 nd object	60ff0020h	Object 60ffh sub-index 0, i32	Target Velocity
Sub-index 3h	Mapping 3 rd object	60ff0020h	Object 60ffh sub-index 0, i32	Target Velocity
Sub-index 4h	Mapping 4 th object	60ff0020h	Object 60ffh sub-index 0, i32	Target Velocity
Sub-index 5h	Mapping 5 th object	60ff0020h	Object 60ffh sub-index 0, i32	Target Velocity
Sub-index 6h	Mapping 6 th object	60ff0020h	Object 60ffh sub-index 0, i32	Target Velocity
Sub-index 7h	Mapping 7 th object	60ff0020h	Object 60ffh sub-index 0, i32	Target Velocity
Sub-index 8h	Mapping 8 th object	60ff0020h	Object 60ffh sub-index 0, i32	Target Velocity

Object 1603h - RPDO 4 Mapping		Value	Description	Function
Sub-index 0h	Number of objects	0	-	-
Sub-index 1h	Mapping 1 st object	-	-	-
Sub-index 2h	Mapping 2 nd object	-	-	-
Sub-index 3h	Mapping 3 rd object	-	-	-
Sub-index 4h	Mapping 4 th object	-	-	-
Sub-index 5h	Mapping 5 th object	-	-	-
Sub-index 6h	Mapping 6 th object	-	-	-
Sub-index 7h	Mapping 7 th object	-	-	-
Sub-index 8h	Mapping 8 th object	-	-	-

4.4 Object 1800h-1803h - TPDO Communication Parameter

Object 1800h-1803h – TPDO Communication Parameter

Index	Sub Index	Parameter Name	Data Type	Access Type	Default Value	Category	PDO Mapping
1800h-1803h		Transmit PDO Communication Parameter 1-4				Mandatory	
	0h	Number of Entries	u8	RO	0x5	Mandatory	No
	1h	COB-ID	u32	RW		Mandatory	No
	2h	Transmission Type	u8	RW		Mandatory	No
	3h	Inhibit Time	u16	RW		Optional	No
	4h	Compatibility Entry	u8	RO		Optional	No
	5h	Event Timer	u16	RW		Optional	No

Sub-index 1h

Contains the COB-ID of the TPDO in the following structure:

Structure of COB-ID of TPDO

31	30	29	28	11	10	1
Valid	1	0	000 000 000 000 00b		11bit CAN-ID	
			29bit CAN-ID			

Bit	Value	Function	
0-10		11bit CAN-ID according to the object	
		Object Number	Default Value
		1800h	180h+Node ID
		1801h	280h+Node ID
		1802h	380h+Node ID
1803h	480h+Node ID		
11-28		29bit CAN-ID (extended)	
29	0	Always 0	
30	1	Always 1	
31	0	PDO enable/valid	
	1	PDO disable/is not valid	

- The validity bit (bit 31) allows the user to configure PDO without having to use it.
- While the PDO is valid (bit 31=0) no other bits can be changed.
- In the event that bit 29 is changed or 29bit CAN-ID is sent, CANopen will send SDO abort code 06090030h.

Sub-index 2h

Defines the transmission type. SGD V-OCB01A can generate PDOs using time triggers or event triggers.

0h	Synchronous-acyclic.
1h	Synchronous-cyclic every SYNC.
2h	Synchronous-cyclic every 2 nd SYNC.
3h	Synchronous-cyclic every 3 rd SYNC.
4h	Synchronous-cyclic every 4 th SYNC.
F0h	Synchronous-cyclic every 240 th SYNC.
F1h...FBh	Reserved
FCh	RTR only (synchronous)
FDh	RTR only (event-driven)
FEh	Event-driven (manufacturer specific)
FFh	Event-driven.

- Synchronous Acyclic - triggered by an application specific event. The message is transmitted synchronously with the Sync object but not periodically.
- Synchronous cyclic - transmitted within the synchronous window. The number of the transmission type (1 to 240) indicates the number of Sync objects between two PDO transmissions.
- RTR synchronous – the device samples data at every SYNC and transmits it on request.
- RTR event-driven – the device starts sampling data on request and transmits it immediately.
- Event-driven – device transmits PDO at every change of the mapped object or the status word (object 6041h).

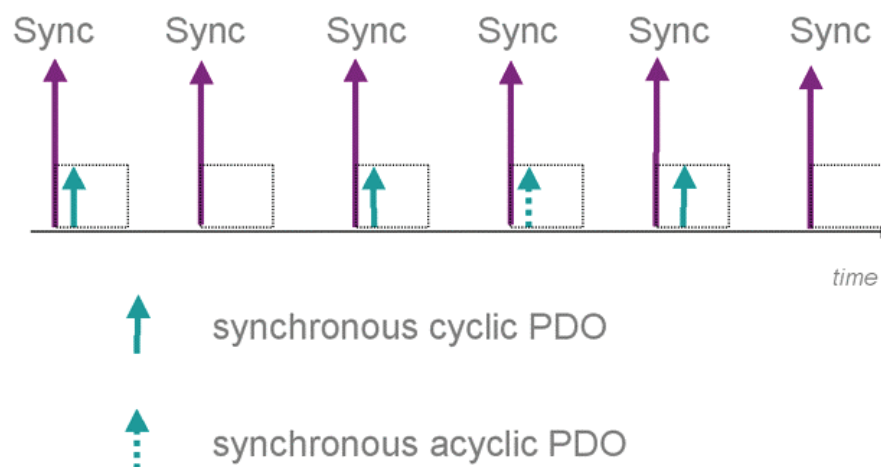

- Any other data will generate SDO abort code 06090030h.

Sub-index 3h

Inhibit time. Defines the minimum time interval between 2 event-driven PDOs (if sub-index 2h = FEh or FFh).

Value range:

0 = disable inhibit time.

0...65535 (1...FFFFh) = time interval in 0,1 msec

While the PDO is valid (bit 31=0 in sub-index 1h) the value can not be changed.

Sub-index 4h

Compatibility entry – reserved.

Any read or write access will generate SDO abort code 06090011h.

Sub-index 5h

Event-timer.

Defines the maximum time interval between 2 event-driven PDOs (if sub-index 2h = FEh or FFh).

Value range:

0 = disable event timer.

0...65535 (1...FFFFh) = time interval in 1 msec

4.5 Object 1A00h-1A03h - TPDO Mapping Parameter

Object 1A00h-1A03h – TPDO Mapping Parameter

Index	Sub Index	Parameter Name	Data Type	Access Type	Default Value	Category	PDO Mapping
1A00h-1A03h		Transmit PDO Mapping Parameter 1-4				Mandatory	
	0h	Number of Entries	u8	RW	See Table	Mandatory	No
	1h	Mapping Entry 1	u32	RW	See Table	Mandatory	No
	2h	Mapping Entry 2	u32	RW	See Table	Optional	No
	3h	Mapping Entry 3	u32	RW	See Table	Optional	No
	4h	Mapping Entry 4	u32	RW	See Table	Optional	No
	5h	Mapping Entry 5	u32	RW	See Table	Optional	No
	6h	Mapping Entry 6	u32	RW	See Table	Optional	No
	7h	Mapping Entry 7	u32	RW	See Table	Optional	No
8h	Mapping Entry 8	u32	RW	See Table	Optional	No	

Sub-index 0h

Number of entries. Number of objects mapped in the PDO.

Value range:

- 0h = disable mapping.
- 1h = 1 object (at least, mandatory)
- 2h = 2 objects.
- 3h = 3 objects.
- 4h = 4 objects.
- 5h = 5 objects.
- 6h = 6 objects.
- 7h = 7 objects.
- 8h = 8 objects (max).

Sub-index 1h to 8h

Application object.

Value range:

31	16	15	8	7	0
Object Index		Sub-Index		Length	

The length is the number of bits in hex format. (For example - Length of objects with data type u32 or i32 is 20h; length of objects with data type u16 or i16 is 10h.)

4.5.1 Default values for TPDO

Object 1A00h - TPDO 1 Mapping		Value	Description	Function
Sub-index 0h	Number of objects	1		-
Sub-index 1h	Mapping 1 st object	60400010h	Object 6041h, sub-index 0, u16	Status Word
Sub-index 2h	Mapping 2 nd object	-	-	-
Sub-index 3h	Mapping 3 rd object	-	-	-
Sub-index 4h	Mapping 4 th object	-	-	-
Sub-index 5h	Mapping 5 th object	-	-	-
Sub-index 6h	Mapping 6 th object	-	-	-
Sub-index 7h	Mapping 7 th object	-	-	-
Sub-index 8h	Mapping 8 th object	-	-	-

Object 1A01h - TPDO 2 Mapping		Value	Description	Function
Sub-index 0h	Number of objects	2		
Sub-index 1h	Mapping 1 st object	60400010h	Object 6041h sub-index 0, u16	Status Word

Object 1A01h - TPDO 2 Mapping		Value	Description	Function
Sub-index 2h	Mapping 2 nd object	60640020h	Object 6064h sub-index 0, i32	Actual position in user units
Sub-index 3h	Mapping 3 rd object	60640020h	Object 6064h sub-index 0, i32	Actual position in user units
Sub-index 4h	Mapping 4 th object	60640020h	Object 6064h sub-index 0, i32	Actual position in user units
Sub-index 5h	Mapping 5 th object	60640020h	Object 6064h sub-index 0, i32	Actual position in user units
Sub-index 6h	Mapping 6 th object	60640020h	Object 6064h sub-index 0, i32	Actual position in user units
Sub-index 7h	Mapping 7 th object	60640020h	Object 6064h sub-index 0, i32	Actual position in user units
Sub-index 8h	Mapping 8 th object	60640020h	Object 6064h sub-index 0, i32	Actual position in user units

Object 1A02h - TPDO 3 Mapping		Value	Description	Function
Sub-index 0h	Number of objects	2		
Sub-index 1h	Mapping 1 st object	60400010h	Object 6041h sub-index 0, u16	Status Word
Sub-index 2h	Mapping 2 nd object	606c0020h	Object 606ch sub-index 0, i32	Actual Velocity value
Sub-index 3h	Mapping 3 rd object	606c0020h	Object 606ch sub-index 0, i32	Actual Velocity value
Sub-index 4h	Mapping 4 th object	606c0020h	Object 606ch sub-index 0, i32	Actual Velocity value
Sub-index 5h	Mapping 5 th object	606c0020h	Object 606ch sub-index 0, i32	Actual Velocity value
Sub-index 6h	Mapping 6 th object	606c0020h	Object 606ch sub-index 0, i32	Actual Velocity value
Sub-index 7h	Mapping 7 th object	606c0020h	Object 606ch sub-index 0, i32	Actual Velocity value
Sub-index 8h	Mapping 8 th object	606c0020h	Object 606ch sub-index 0, i32	Actual Velocity value

Object 1A03h - TPDO 4 Mapping		Value	Description	Function
Sub-index 0h	Number of objects	0	-	-
Sub-index 1h	Mapping 1 st object	-	-	-
Sub-index 2h	Mapping 2 nd object	-	-	-

Object 1A03h - TPDO 4 Mapping		Value	Description	Function
Sub-index 3h	Mapping 3 rd object	-	-	-
Sub-index 4h	Mapping 4 th object	-	-	-
Sub-index 5h	Mapping 5 th object	-	-	-
Sub-index 6h	Mapping 6 th object	-	-	-
Sub-index 7h	Mapping 7 th object	-	-	-
Sub-index 8h	Mapping 8 th object	-	-	-

4.6 Mapping procedure

The following procedure is used for mapping, which may take place during the Pre-operational NMT state.

The procedure is relevant to RPDO and to TPDO.

1. Remove the PDO by setting the validity bit (bit 31) to 1b in sub-index 01h of the corresponding PDO communication object.
2. Disable mapping by setting sub-index 00h of the according mapping object to 00h.
3. Assign objects to corresponding sub-indexes (object A to sub-index 01h, object B to sub-index 02h.)
4. Enable mapping by setting sub-index 00h of the mapping object to the number of the mapped objects.
5. Create a PDO by setting the validity bit (bit 31) to 0b in sub-index 01h of the corresponding PDO communication object.
 - If during step 3 the CANopen device detects that the mapping object and sub index are not existing or cannot be mapped, the device will generate SDO abort code 06020000h or 06040041h.
 - If during step 4 the CANopen device detects that the RPDO is not valid or not possible, the device will generate SDO abort code 06020000h or 06040042h.

The following example describes the process of mapping a status word (6041h) and position actual value (6064h) into TPDO1.

Example

The Node-ID is 7.

The TPDO1 communication object is 1800h.

The TPDO1 mapping object is 1A00h and should perform as shown in Table 49 at the end of the procedure.

Object 1800h - TPDO 1 Mapping	
Sub-index 0h	2
Sub-index 1h	6041h
Sub-index 2h	6064h

The Required CAN Messages

#	r/w	Index	Sub Index	Data Type	Value	Description
1	w	0x1800	1	u32	C0000187h	Disable TPDO1 for Node-ID 7 (180 +7) Bit 31=1 (Binary)
2	w	0x1a00	0	u32	0	Destroying the number of the mapped objects in the mapping object
3	w	0x1a00	1	u32	60410010h	Map object 6041h, sub index 0, data type u16 (10h)
4	w	0x1a00	2	u32	60640020h	Map object 6063h, sub index 0, data type i32 (20h)
5	w	0x1a00	0	u8	2	Declaring about 2 objects that have been entered
6	w	0x1800	1	u32	40000187h	Enable TPDO1 for Node-ID 7 (180+7) Bit 31=0 (Binary)

5 Manufacturer specific objects

5.1 Object 2004h - Utility servo function

Utility servo function

Index	Sub Index	Parameter Name	Data Type	Access Type	Default Value	Category	PDO Mapping
2004h	0h	Utility servo function	i8	RW	0	Manufacturer specific	No

This object should be used for the SERVOPACK utility function. By setting the value with SDO, the indicated function is started. After that, the value shows the status of the function.

Value range: Integer 8

Data description

Value	Data description	Explanation
-128 to -2	Reserved	
-1	Error operation	Last function completed with error
0	No operation (normal mode)	No effect. Completed without error.
1	Node reset	Node is reset by oneself automatically. Another way of doing Reset by NMT message - Reset Application.
2 to 127	Reserved	No effect

Note: While executing, the value is kept in this object. When the function is completed, the value will be set to 0 or less according to the status. During the execution the value cannot be set to a different value.

5.2 Object 203fh - Manufacturer error code

Manufacturer error code

Index	Sub Index	Parameter Name	Data Type	Access Type	Default Value	Category	PDO Mapping
203fh	0h	Manufacturer error code	u32	RO	00000000h	Manufacturer specific	Yes

This object defines the error code specified by the manufacturer.

Value range: Unsigned 32

Data description

The object consists of 4 bytes with the data as shown in the description below. Emergency error code and fault code is referred to section 15.6 *Emergency message* and 15.7 *Error code chart*.

Byte	3	2	1	0
Error Monitor	Reserved	Attribute	Fault Code	

Note: The object shows not only Sigma-V alarm codes but also Sigma-V warning codes.

5.3 Object 2100h - Get Parameter

Get Parameter

Index	Sub Index	Parameter Name	Data Type	Access Type	Default Value	Category	PDO Mapping
2100h		Get Parameter					
	0h	Number of Entries	u8	RO			
	1h	Parameter ID	u16	RW			
	2h	Parameter value	i16	RO			

SGDV-OCB01A can enable the user to read the SGDV parameters via the CANopen network. Parameters can only be handled by the CANopen SDO service and can not map to PDOs. The SDO client performs the following operations:

1. Sets the parameter ID to object 2100h/1h.
2. Reads the parameter value from object 2100h/2h.

5.4 Object 2101h - Set Parameter

Set Parameter

Index	Sub Index	Parameter Name	Data Type	Access Type	Default Value	Category	PDO Mapping
2101h		Set Parameter					
	0h	Number of Entries	u8	RO			
	1h	Parameter ID	u16	RW			
	2h	Parameter value	i16	RW			

The CANopen SDO client can write each SGDV-parameter value with the object 0x2101. The SDO client performs the following operations:

1. Sets the parameter ID to object 0x2101/1.
2. Writes the value to object 0x2101/2.

This object is only active when the SGDV-OCB01A is in SWITCH ON DISABLED machine state (this can be done by CAN master or by sending the value 0 to the control word-object 6040h/0h). Sending object 2101h when the machine is in another state will generate SDO abort code 8000022h.

Some of the SGDV parameters only become effective after a RESET. (For details see the related manuals.) Changing these parameters requires the user to reset the SGDV.

5.5 Object 2211h - Read Monitor

Read monitor

Index	Sub Index	Parameter Name	Data Type	Access Type	Default Value	Category	PDO Mapping
2211h		Read monitor					
	0h	Number of Entries	u8	RO			
	1h	Var ID	u8	RW			
	2h	Var value	i32	RO			

SGDV-OCB01A enables the user to read the SGDV monitor via the CANopen network. Data can only be handled by the CANopen SDO service and can not map to PDOs. The SDO client performs the following operations:

- Sets the monitor ID to object 2211h/1h.
- Reads the data value from object 2211h/2h.

5.6 Object 2300h - User unit group enable

User unit group enable

Index	Sub Index	Parameter Name	Data Type	Access Type	Default Value	Category	PDO Mapping
2300h		User unit group enable	u8	RW	1		No

Data Description:

This object enables the setting of the user units.

Procedure:

1. FSA state must be "Switch ON disabled".
2. Set value to 0.
3. Set the relevant User Units objects.
4. Set 2300h object to 1 to activate the new user units.

After this procedure Sigma-5 will automatically update all values to the "new" units.

5.7 Object 2301h - Position User Unit

Position user unit

Index	Sub Index	Parameter Name	Data Type	Access Type	Default Value	Category	PDO Mapping
2301h		Position user unit					
	0h	Number of Entries	u8	RO	2		No
	1h	Numerator	u32	RW	1		No
	2h	Denominator	u32	RW	1		No

5.8 Object 2302h - Velocity User Unit

Velocity user unit

Index	Sub Index	Parameter Name	Data Type	Access Type	Default Value	Category	PDO Mapping
2302h		Velocity user unit					
	0h	Number of Entries	u8	RO	2		No
	1h	Numerator	u32	RW	1		No
	2h	Denominator	u32	RW	1		No

5.9 Object 2303h - Acceleration User Unit

Acceleration user unit

Index	Sub Index	Parameter Name	Data Type	Access Type	Default Value	Category	PDO Mapping
2303h		Acceleration user unit					
	0h	Number of Entries	u8	RO	2		No
	1h	Numerator	u32	RW	1		No
	2h	Denominator	u32	RW	1		No

Settings of the objects 2301h, 2302h, 2303h

In the following examples the setting of the Position (2301h), Velocity (2302h) and Acceleration (2303h) will be explained.

There are basically 2 types of user unit settings for the following basic applications:

- Applications for linear movements using a ballscrew or linear motors.
- Applications using gear boxes for rotary movement.

Also there are two ways to set the user acceleration unit considering the dimensions:

- Type 1 is to set the "Time Constant" data for top speed, for example 80 msec acceleration for 1000 mm/sec.
- Type 2 is to set physical data, such as mm/sec² or Deg/sec².

Note: When setting another user unit, the ratio between numerator (sub index 1h) and denominator (sub index 2h) must be below 1000. If this condition is not fulfilled, the new user unit will not be enabled.

Example for ballscrew application

1. User requirements and application data

- 1) User position unit = 0.001 mm
- 2) User velocity unit = 1 mm/sec
- 3) User acceleration unit
 - Type 1: = 1/1000 (0.1 %) of the calculated acceleration for the target application.
 - Type 2: = 1 mm/sec².
- 4) Application data
 - Encoder = 20 bit (1048576 counts/rev)
 - The movement for 1 motor revolution = 2 mm.
- 5) User acceleration type 1 "Time Constant" data for top speed
 - Top speed = 1000 mm/sec (60 m/min).
 - Calculated acceleration time to top speed = 80 msec.
 - Note: calculated acceleration for the target application = 12500 mm/sec² = 1.275G.

2. Setting

- 1) Position user unit (2301h): Number of encoder counts for One user position unit
 Number of encoder counts for 1 mm (1000 user position units).
 $= \{(1048576 \text{ counts/rev}) / (2 \text{ mm/rev})\} * 1 \text{ mm} = 524288 \text{ counts.}$
 Numerator = 524288
 Denominator = 1000
- 2) Velocity user unit (2302h): Number of encoder counts per msec for One user velocity unit.
 Number of encoder counts per sec for 1 mm/sec (1 user velocity unit).
 $= \{(1048576 \text{ counts/rev}) / (2 \text{ mm/rev})\} * 1 \text{ mm} = 524288 \text{ counts/sec: } 1000 \text{ msec.}$
 Numerator = 524288
 Denominator = 1000
- 3) Acceleration user unit (2303h): Number of encoder counts increments per msec. for One user acceleration unit.

 Type 1
 Number of encoder counts per msec for top speed = 1000 mm/sec = 1mm/msec
 $= \{(1048576 \text{ counts/rev}) / (2 \text{ mm/rev})\} * 1 \text{ mm/msec} = 524288 \text{ counts/msec.}$
 Numerator = 524288
 Denominator = 80 * 1000

 Type 2
 Number of encoder counts per msec for 1 mm/sec = 524288 counts/msec.
 Number of encoder counts increments / msec for 1 mm/sec = 524288/1000*1000.
 Numerator = 524288 * 100
 Denominator = 1000 * 1000

Example for rotary table application

1. User requirements and application data

Note: Deg, Rev = dimension for rotary table, deg, rev = servomotor dimension

1) User position unit = 0.001 Deg

2) User velocity unit = 1 Deg/sec

3) User acceleration unit

Type 1: = 1/1000 (0.1 %) of the calculated acceleration for the target application.

Type 2: = 1 Deg/sec².

4) Application data

Encoder = 20 bit (1048576 counts/rev)

The rotary table moves 36 Degrees for 1 motor revolution.

5) User acceleration type 2 "Time Constant" data for top speed = 10 Rev/sec

(3600 Deg/rev)

Top speed = 10 Rev/sec (3600 Deg/sec).

Calculated acceleration time to top speed = 80 msec.

Note: calculated acceleration for the target application = 45000.

2. Setting

1) Position user unit (2301h): Number of encoder counts for One user position unit

Number of encoder counts for One user position unit = 0.001 Deg.

= $\{(1048576 \text{ counts/rev}) / (36 \text{ Deg/rev})\} * 0.001 \text{ Deg} = 1048576/36 \text{ counts/sec: } 1000 \text{ msec.}$

Numerator = 1048576

Denominator = 36*1000

2) Velocity user unit (2302h): Number of encoder counts per msec for One user velocity unit

Number of encoder counts per sec for One user velocity unit = 1 Deg/sec.

= $\{(1048576 \text{ counts/rev}) / (36 \text{ Deg/rev})\} * 1 \text{ Deg/sec} = 1048576/36 \text{ counts/sec: } 1000 \text{ msec.}$

Numerator = 1048576

Denominator = 36*1000

3) Acceleration user unit (2303h): Number of encoder counts increments per msec. for One user acceleration unit.

Type 1

Number of encoder counts per msec. for top speed = 3600 Deg/sec = 3.6 Deg/msec

= $\{(1048576 \text{ counts/rev}) / (36 \text{ Deg/rev})\} * 3.6 \text{ Deg/msec} = 1048576/10$

Numerator = 1048576*100

Denominator = 10*80 *1000

Type 2

Number of encoder counts per msec. for 1 Deg/sec.

= $\{(1048576 \text{ counts/rev}) / (36 \text{ Deg/rev})\} / 1000 \text{ msec} = 1048576/10/36*1000$

Number of encoder counts increments per msec for 1 Deg/sec

= $1048576/(36*1000*1000)$

Numerator = 1048576 * 100

Denominator = 36*1000 *1000

Example for linear motor application

1. User requirements and application data

A linear motor moves a distance $AB = 1.4$ m.

The motor acceleration and deceleration is equal to 5000 mm/s^2 .

The cruising velocity is equal to 1000 mm/s .

The linear scale pitch is equal to $20 \mu\text{m}$ and an 8 bit serial converter is connected to the motor.

2. User settings and configuration:

Position user units:

- Numerator = $2301\text{h}/1\text{h} = 2^8$ (resolution of serial converter) = 256 dec

- Denominator = $2301\text{h}/2\text{h} = 20$ dec (linear scale pitch)

Velocity user units:

Numerator = $2302\text{h}/1\text{h} = 2^8$ (resolution of serial converter) = 256 dec

Denominator = $2302\text{h}/2\text{h} = 20$ dec (linear scale pitch)

User acceleration units:

Numerator $2303\text{h}/1\text{h} = 2^8/20 * 1000$ (resolution of serial converter/linear scale pitch * 1000) = $256/20 * 1000$ dec = 12800

Denominator $2303\text{h}/2\text{h} = 10000$ dec

3. Profile position objects:

Profile velocity = $6081\text{h}/1\text{h} = 1000$ dec

Profile acceleration = $6083\text{h}/1\text{h} = 5000$ dec

Profile deceleration = $6084\text{h}/1\text{h} = 5000$ dec

Target Position = $607\text{Ah}/1\text{h} = 1400000$ dec

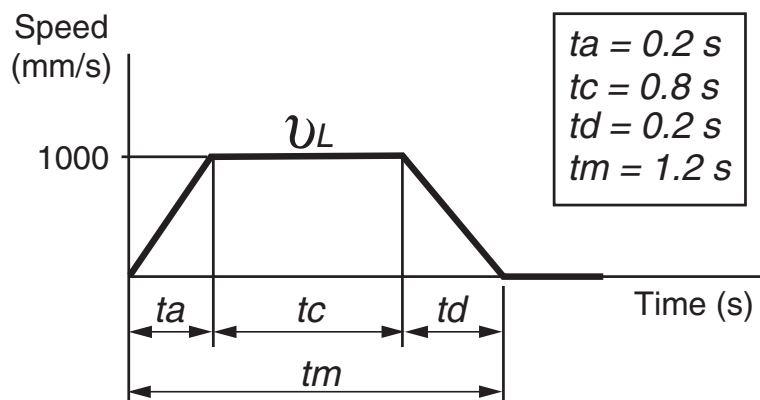

5.10 Object 2400h - Position Range Limit Designation

Position Range Limit Designation

Index	Sub Index	Parameter Name	Data Type	Access Type	Default Value	Category	PDO Mapping
2400h		Position range limit designation	u8	RW	0	Manufacturer specific	No

Data description

Position range limit for (607Bh)

- 0: Off
- 1: Shortest Path
- 2: Fixed rotation direction positive
- 3: Fixed rotation direction negative

Note: When the mode “Shortest Path” is selected, the drive always moves the physically shortest distance to the target position and adjusts the sign of the running speed accordingly. For the modes “Fixed rotational direction...” the drive always moves in the direction specified by the appropriate mode.

5.11 Object 2401h - Target_Position_In_Range

Target_Position_In_Range

Index	Sub Index	Parameter Name	Data Type	Access Type	Default Value	Category	PDO Mapping
2401h		Target_Position_In_Range	i32	RO	0	Manufacturer specific	Possible

Units:

Pos Units

Data description

The warped target command value when Position range limit executed.

5.12 Object 2402h - Actual_Position_In_Range

Actual_Position_In_Range

Index	Sub Index	Parameter Name	Data Type	Access Type	Default Value	Category	PDO Mapping
2402h		Actual_Position_In_Range	i32	RO	0	Manufacturer specific	Possible

Units:

Pos Units

Data description

The warped actual position value when Position range limit executed.

6 Device control objects

6.1 SGDV-OCB01A Device control - General

SGDV-OCB01A can be controlled in three ways:

- CAN network management (NMT)
- Controlling power drive system
- Modes of operation

6.1.1 CAN network management (NMT)

The NMT state machine determines the behavior of CANopen communication functions and what services are enabled.

There are 4 NMT machine states:

- **Initialization**
 - Initialization – Comes right after power-up or hardware reset. The NMT state machine automatically continues to the next state.
 - Reset application – Sets the power on profile values from non-volatile memory.
 - Reset communication – Sets the communication values from the non-volatile memory.
- **Pre-operational** – Communication via SDO service is possible. PDO service is disabled but configuring PDO is enabled.
- **Operational** – All communication objects are active.
- **Stopped** – All communication objects are inactive except node control and error control.



IMPORTANT

The CANopen NMT master should comply with the following rules:

- The NMT message should not be sent with intervals shorter than 2 ms to the same node.
- The NMT master should wait for the boot-up message before sending another NMT reset.

The boot-up message is sent by a device when it boots up or after a power-out during operation. It is sent to the CANopen NMT master to indicate that the device has reached the state Pre-operational.

The NMT states are described in the following diagram.

The NMT states and transitions are specified in the CiA standard 301.

Network Management (NMT) States and Transitions

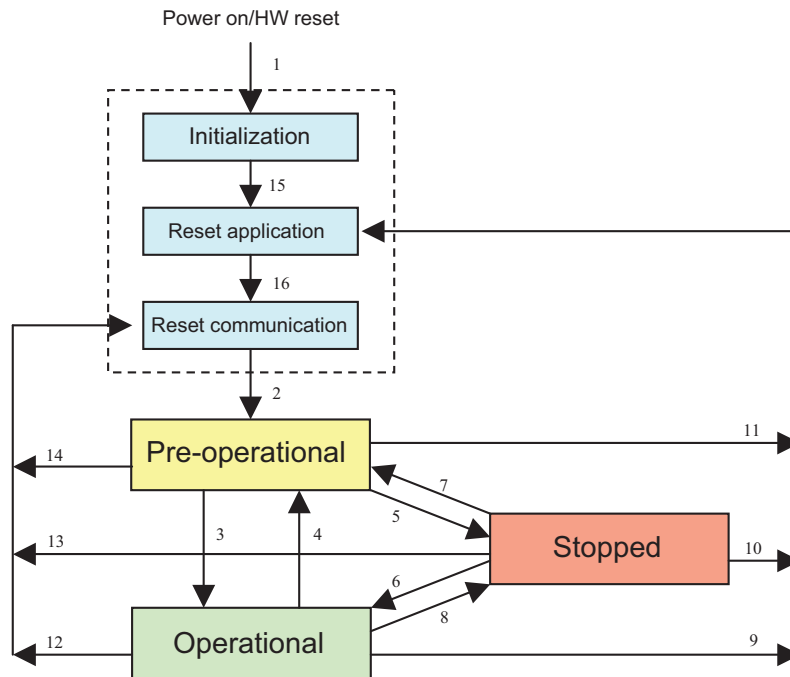

6.1.2 Controlling the Power Drive System (PDS)

The power drive system defines how the SGD V responds to the user control word (object 6040h), user commands, local signals or fault events. The status word (object 6041h) monitors the state of the drive power.

The states and the transitions are displayed in the figure below and the following table.

Power Drive Systems States and Transitions

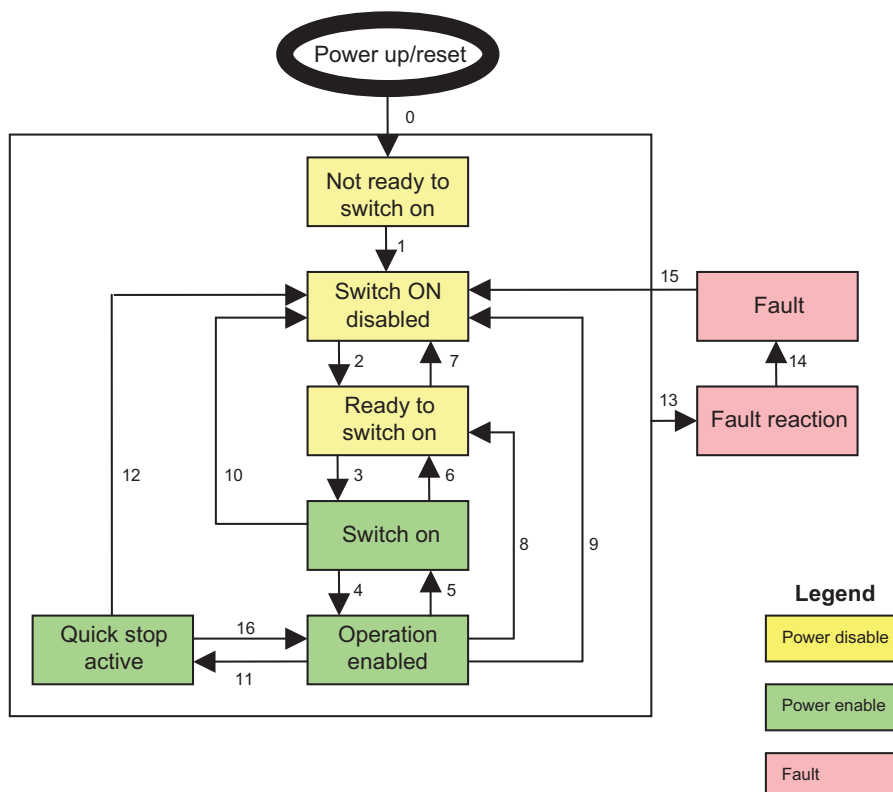

SGDV-OCB01A PDS Transitions

CANopen Transition	CANopen event	SGDV-OCB01A Action
0	Automatic transition after power up or HW reset.	Self-initialization
1	Automatic transition	CANopen and serial communication are activated. Sends POLLING requests to the SGD V until the SGD V answers. Requests the SGD V version. Sets the serial monitoring time. Loads parameters and variables from the SGD V.
2	Shutdown command from device control.	None
3	Switch On command received from device control.	Enables SGD V
4	Enable operation command received from device control.	Drive functions are enabled, start motion of SGD V.
5	Disable operation command received from device control.	Drive functions are disabled, stop motion of SGD V.
6	Shut down command received from device control.	Disables SGD V
7	Quick stop command received from the device control.	None
8	Shutdown command received from device control.	Disables SGD V
9	Disable voltage command received from device control.	Disables SGD V
10	Disable voltage or quick stop command received from device control.	Disables SGD V
11	Quick stop command received from device control.	Executes quick stop function. Stops motion.
12	Automatic transition when the quick stop function is completed. Or Disable voltage command received from device control.	Disables SGD V
13	Error detected. Stop remote node, reset node, reset communication received	Executes error fault reaction. Starts error handling.
14	Automatic transition.	Disables SGD V
15	Fault reset command from device control.	Clears errors (depending on the error.)
16	Enable operation command from device control not supported (not recommended by CiA and object 605Ah not supported.)	None

6.1.3 Modes of operation

The translation of a user command into actual motion depends on the selected mode of operation. The mode of operation has influence on some of the objects and these mode-specific objects will act differently depending on the mode selection.

The SGDV-OCB01A has the following modes of operation:

- Pole detection mode
- Profile position mode
- Homing mode
- Profile velocity mode
- Profile torque mode
- Interpolated position mode

6.2 Object 603fh – Error code

Object 603fh - Error Code

Index	Sub Index	Parameter Name	Data Type	Access Type	Default Value	Category	PDO Mapping
603fh	0h	Error code	u16	RO	0000h	Optional	Yes

This object provides the error code of the last error which occurred in the drive device.

Value range: unsigned 16

6.3 Object 6040h – Control Word

Object 6040h - Control Word

Index	Sub Index	Parameter Name	Data Type	Access Type	Default Value	Category	PDO Mapping
6040h	0h	Control word	u16	RW		Optional	Yes

This object defines and controls the Power Drive System (PDS) state and sets the motion functionality depending on the selected mode of motion.

The object structure is a 16 bit word. The function of each bit is described in the table below.

Bit Functions

Bit	Function	Meaning
0	Switch on	Changing machine state. See table Machine Commands and Transitions.
1	Enable voltage	Changing machine state. See table Machine Commands and Transitions.
2	Quick stop	Changing machine state. See table Machine Commands and Transitions.
3	Enable operation	Changing machine state. See table Machine Commands and Transitions.
4	Operation mode specific	Definitions on the specific mode section.
5		

Bit	Function	Meaning
6		
7	Fault reset	Changing machine state. See table Machine Commands and Transitions.
8	Halt	Operation mode specific functionality. Definitions on the specific mode section.
9, 10	Reserved	
11 - 15	Manufacturer specific	

The machine state command and the transition based on the control word coding are displayed in the table below.

Machine Commands and Transitions

Command	Control Word Bits					Transition
	7	3	2	1	0	
Shutdown	0	X	1	1	0	2, 6, 8
Switch on	0	0	1	1	1	3
Switch on + enable operation	0	1	1	1	1	3 and 4
Disable voltage	0	X	X	0	X	7, 9, 10, 12
Quick stop	0	X	0	1	X	7, 10,11
Disable operation	0	0	1	1	1	5
Enable operation	0	1	1	1	1	4, 16
Fault reset	↑1	X	X	X	X	15

6.4 Object 6041h – Status Word

Table 65: Object 6041h – Status Word

Index	Sub Index	Parameter Name	Data Type	Access Type	Default Value	Category	PDO Mapping
6041h	0h	Status word	u16	RO		Optional	Yes

This object indicates the current state of the power drive system.

Value range:

The object structure is a 16 bit word. The function of each bit is described in the following table.

Bit Functions

Bit	Function	Meaning
0	Ready to switch on	Machine state change. See Table status words (below).
1	Switched on	Machine state change. See Table status words (below).
2	Operation enabled	Machine state change. See Table status words (below).
3	Fault	Machine state change. See Table status words (below).
4	Voltage enabled	=1, voltage on
5	Quick stop	=0, quick stop request
6	Switch on disabled	Machine state change. See Table status words (below).
7	Warning	=1, warning
8	Manufacturer specific	
9	Remote	=1, status word is processed
10	Target reached	Operation mode specific functionality. Definitions on the specific mode section.
14	HBB signal	=0, interlock circuit closed =1, interlock circuit open For more detailed information about this bit, please refer to section 14.7.4 <i>Recovery Procedure after the interlock circuit is open</i>

Status Words and Corresponding Machine State

Status word (binary code)	Machine state
x0xx xxxx x0xx 0000	Not ready to switch on
x0xx xxxx x1xx 0000	Switch on disabled
x0xx xxxx x01x 0001	Ready to switch on
x0xx xxxx x01x 0011	Switch on
x0xx xxxx x00x 0111	Operation enabled
x0xx xxxx x00x 0111	Quick stop active
x0xx xxxx x0xx 1111	Fault reaction active
x0xx xxxx x0xx 1000	Fault

6.5 Object 6060h - Modes of Operation

Modes of Operation

Index	Sub Index	Parameter Name	Data Type	Access Type	Default Value	Category	PDO Mapping
6060h	0h	Modes of operation	i8	RW		Optional	Yes

This object indicates the requested mode of motion.

Value range

Value	Mode of operation
-1	Pole detection mode
0	No mode assigned
1	Profile position mode
2	Not supported
3	Profile velocity mode
4	Profile torque mode
5	Reserved
6	Homing mode
7	Interpolated position mode

6.6 Object 6061h - Modes of Operation Display

Object 6061h – Modes of Operation Display

Index	Sub Index	Parameter Name	Data Type	Access Type	Default Value	Category	PDO Mapping
6061h	0h	Modes of operation display	i8	RW		Optional	Yes

This object indicates actual motion mode.

Note: Since the SGD V-OCB01A allows the user to switch between modes of operation dynamically during motion, this object will be updated to the requested mode of operation (object 6060h) only when the state machine is in OPERATION ENABLED and after rising bit 4 of the control word (in the modes of operation that conditioned this bit to start a new motion).

Value range

Value	Mode of operation
-1	Pole detection mode
0	No mode assigned
1	Profile position mode
2	Not supported
3	Profile velocity mode
4	Profile torque mode
5	Reserved
6	Homing mode
7	Interpolated position mode

7 Pole detection mode

7.1 Introduction

Setting the Pole detection mode of operation enables the pole detection in which a magnetic pole of a linear motor connected to a SERVOPACK can be detected. When an incremental linear scale is used, the detected phase information will not be saved and thus, the pole detection mode is required at every power ON. When an absolute linear scale is used, the detected information will be saved into both SERVOPACK and serial converter (or the equivalent) connected to the SERVOPACK.

7.2 Mode of operation (6060h)

The pole detection code is -1.

7.3 Control word (6040h)

In the following CiA402 FSA transition the pole detection starts:

- From Ready to switch ON to Switch ON.
- From Ready to switch ON to Operation enabled.

In the following CiA402 FSA transition the pole detection should be stopped:

- To Switch ON disabled.
- To Ready to switch ON.
- Fault.

CAUTION



During the pole detection process the motor can move in great distance !!!

7.4 Status word (6041h)

Bit 13	Bit 12	Description
0	0	None
0	1	Pole detection completed
1	0	Pole detection in process
1	1	Reserved

7.5 Pole detection condition

Rule1:

Transition to Pole detection mode is only in Servo OFF states.

Rule2:

Transition from Pole detection mode to other modes is only in Servo OFF states and after Pole detection completed.

Rule3:

Any attempt to violate Rule1 or 2 will result in SDO Abort code 0x0609 0030.

Note:

After the pole detection function is successfully performed, the mode of operation must be set depending on the application.

8 Profile position objects

8.1 Mode specific control word

The profile position mode uses some bits from the control word (object 6040h) under certain circumstances.

If no previous motion is being processed, bit 4 will start the axis motion.

Control word bits

Bit	Function	Meaning
4	New set point	=0; No new set point is demanded =1; New set point is demanded The activation of the new set point will be at the bit rising.
5	Change set point immediately	=0; the next target set point will start after the current motion completes (target reached) =1; the next target set point will start immediately
6	Absolute/relative	=0; target set point will be in absolute values =1; target set point will be in relative values
8	Halt	=1; axis will stop with deceleration

8.2 Mode specific status word

Bit functions

Bit	Function	Meaning
10	Target reached	In the event that the driver is not in Halt state (object 6040h bit 8 =0) =0; target position not reached =1; target position reached In the event that the driver is in Halt state (object 6040h bit 8 =1) =0; axis during deceleration =1; velocity is 0
12	Set point acknowledgement	=0; ready to accept a new set point =1; previous set point in progress
13	Following error	=0; no following error =1; following error

8.3 Object 6067h - Position Window

Object 6067h – Position Window

Index	Sub Index	Parameter Name	Data Type	Access Type	Default Value	Category	PDO Mapping
6067h	0h	Position window	u32	RW		Optional	Yes

This object indicates the configured symmetrical range of accepted positions relative to the target position. If the actual value of the position encoder is within the position window, the target position has been reached. The value is given in user-defined position units.

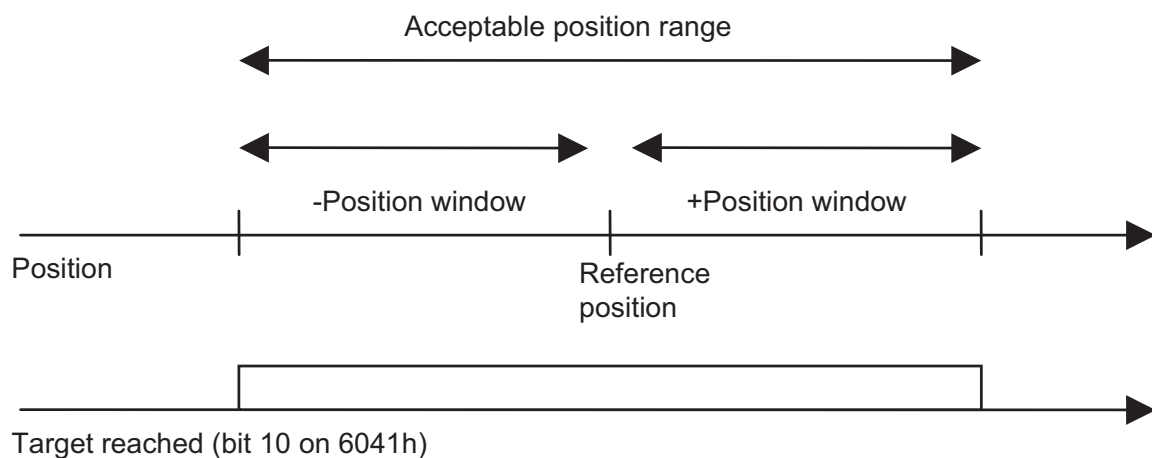

Value range:

0 - 255 (0 - FFh) [Position User Units]

8.4 Object 6068h - Position Window Time

Object 6068h - Position window time

Index	Sub Index	Parameter Name	Data Type	Access Type	Default Value	Category	PDO Mapping
6068h	0h	Position window time	u32	RW	32 Dec.	Optional	Yes

Description:

When the actual position is within the position window during the defined position window time which is given in multiples of msec., the corresponding bit 10 target reached in the status word will be set to 1.

8.5 Object 607Fh - Maximum Profile Velocity

Object 607Fh – Maximum Profile Velocity

Index	Sub Index	Parameter Name	Data Type	Access Type	Default Value	Category	PDO Mapping
607Fh	0h	Maximum profile velocity	u32	RW		Optional	Yes

This object defines the maximum permitted velocity during a profiled motion. This parameter is the upper speed limit while calculating the motion profile.

Value range:

[velocity user units].

8.6 Object 6081h - Profile Velocity

Object 6081h – Profile Velocity

Index	Sub Index	Parameter Name	Data Type	Access Type	Default Value	Category	PDO Mapping
6081h	0h	Profile velocity	u32	RW		Mandatory	Yes

This object defines the desired velocity at the end of the acceleration ramp during profile position motion. The velocity is valid for both directions since the direction is set by the target position relative to the current position.

Value range:

0...4294967295 (0...FFFFFFFFh) [velocity user units].

8.7 Object 6083h - Profile Acceleration

Object 6083h – Profile Acceleration

Index	Sub Index	Parameter Name	Data Type	Access Type	Default Value	Category	PDO Mapping
6083h	0h	Profile acceleration	u32	RW		Mandatory	Yes

The object defines the desired acceleration during profile position motion.

Value range:

0...4294967295 (0...FFFFFFFFh) [acceleration user units].

8.8 Object 6084h - Profile Deceleration

Object 6084h – Profile Deceleration

Index	Sub Index	Parameter Name	Data Type	Access Type	Default Value	Category	PDO Mapping
6084h	0h	Profile deceleration	u32	RW		Optional	Possible

The profile deceleration is given in the same units as the profile acceleration. If this parameter is not used, the profile acceleration value is also used for the deceleration.

8.9 Object 6085h - Quick Stop Deceleration

Object 6085h – Quick stop deceleration

Index	Sub Index	Parameter Name	Data Type	Access Type	Default Value	Category	PDO Mapping
6085h	0h	Quick stop deceleration	u32	RW	See note	Optional	Possible

The quick stop deceleration is the deceleration value used to stop the motor if the “Quick Stop” command is given and the quick stop option code (see 605Ah) is set to 2.

The quick stop deceleration is given in the same units as the profile acceleration.

Note: The default value is calculated related to the value taken from the SGDV on initialization.

8.10 Object 607Ah - Target Position

Object 607Ah – Target Position

Index	Sub Index	Parameter Name	Data Type	Access Type	Default Value	Category	PDO Mapping
607Ah	0h	Target position	i32	RW		Mandatory	Yes

This object defines the target position value for the next profile position motion. The value can be in terms of relative position or in terms of absolute position, depending on bit 5 in the control word (object 6040h).

Value range:

-2147483648...+2147483627 (80000000h...7FFFFFFFh) [position user units].

8.11 Object 6062h – Position Demand Value in User Units

Object 6062h – Position Demand Value in User Units

Index	Sub Index	Parameter Name	Data Type	Access Type	Default Value	Category	PDO Mapping
6062h	0h	Position demand value	i32	RO		Optional	Yes

This object contains the value of the demanded position in the closed-loop cycle calculations. This value is the reference command for the trajectory generator.

Value range:

-2147483648...+2147483627 (80000000h...7FFFFFFFh) [position user units].

8.12 Object 6063h – Position Actual Value

Object 6063h – Position Actual Value

Index	Sub Index	Parameter Name	Data Type	Access Type	Default Value	Category	PDO Mapping
6063h	0h	Position actual value	i32	RO		Optional	Yes

This object contains the value of the actual position for the closed loop position control calculations.

Value range:

-2147483648...+2147483627 (80000000h...7FFFFFFh) [position units].

8.13 Object 6064h – Position Actual Value in User Units

Object 6064h – Position Actual Value in User Units

Index	Sub Index	Parameter Name	Data Type	Access Type	Default Value	Category	PDO Mapping
6064h	0h	Position actual value in user units	i32	RO		Optional	Yes

The object contains the value of the actual position in user units.

Value range:

-2147483648...+2147483627 (80000000h...7FFFFFFh) [position user units].

9 Homing mode objects

9.1 Mode specific control word

The homing mode uses some bits from the control word (object 6040h) under certain circumstances.

Bit functions

Bit	Function	Meaning
4	Start homing	=0; do not start homing. =1; start or continue homing procedure.
5	Reserved	
6	Reserved	
8	Halt	Not supported

9.2 Mode specific status word

Command	Control Word Bits					Transition
	7	3	2	1	0	
Shutdown	0	X	1	1	0	2, 6, 8
Switch on	0	0	1	1	1	3
Switch on + enable operation	0	1	1	1	1	3 and 4
Disable voltage	0	X	X	0	X	7, 9, 10, 12
Quick stop	0	X	0	1	X	7, 10, 11
Disable operation	0	0	1	1	1	5
Enable operation	0	1	1	1	1	4, 16
Fault reset	↑1	X	X	X	X	15

Homing status

Homing status	Control Word Bits		
	Homing error Bit 13	Homing attained Bit 12	Target reached Bit 10
Homing in progress	0	0	0
Homing interrupted or not started yet	0	0	1
Homing attained but target not reached	0	1	0
Homing was completed successfully	0	1	1

Homing status	Control Word Bits		
	Homing error Bit 13	Homing attained Bit 12	Target reached Bit 10
Homing error, speed \neq 0	1	0	0
Homing error, speed = 0	1	0	1

9.3 Object 607Ch – Home Offset

Object 607Ch – Home Offset

Index	Sub Index	Parameter Name	Data Type	Access Type	Default Value	Category	PDO Mapping
607Ch	0h	Home offset	i32	RW	0x00000000	Optional	Yes

This object shell indicates the difference between the zero position discovered during the homing procedure and the application desired zero position. By setting the home offset, the zero position will be offset from its physical position by the offset value. Negative values indicate an offset in the opposite direction.

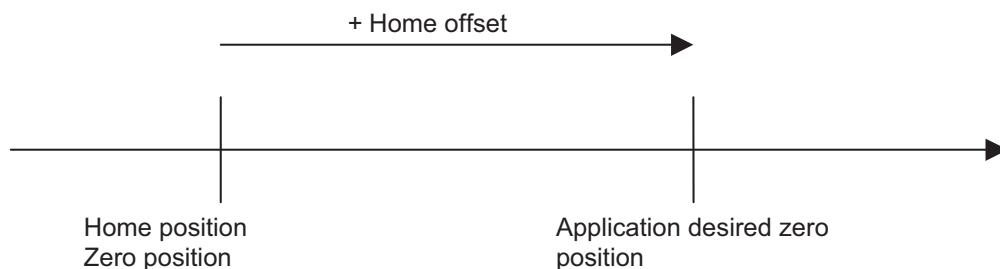

9.4 Object 6098h - Homing Method

Homing Method

Index	Sub Index	Parameter Name	Data Type	Access Type	Default Value	Category	PDO Mapping
6098h	0h	Homing method	i8	RW		Mandatory	Yes

This object defines the homing method. During the homing procedure, the device searches for an external or internal sensor. It can be a limit switch, a dedicated home sensor, a hard stop and/or an encoder index. Once it is found, the device resets the position counter and decelerates until it stops.

The following methods are supported:

Method 1 - Homing on the negative limit switch and index pulse

The axis will search for the rising edge of the negative limit switch by speed command in the negative direction. Once found, it will change direction and search for the falling edge of the limit. The next encoder index in the right direction will be the zero position.

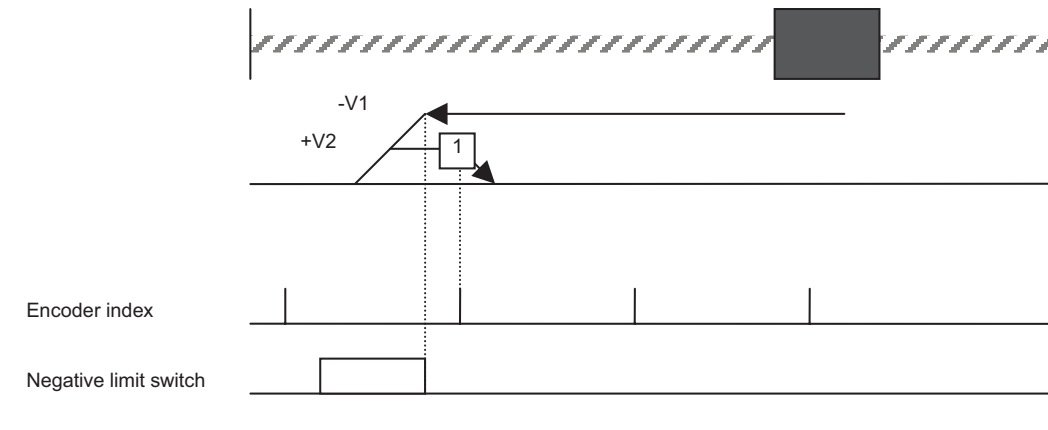

Method 2 - Homing on the positive limit switch and index pulse

The axis will search for the rising edge of the positive limit switch by speed command in the positive direction. Once found, it will change direction and search for the falling edge of the limit. The next encoder index in the left direction will be the zero position.

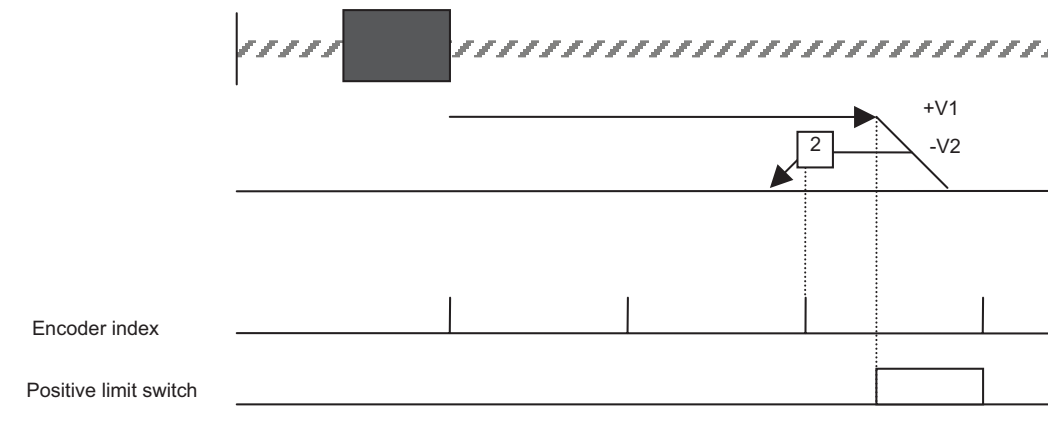

Method 3 - Homing on the home switch and the index pulse

Positive direction search - The axis will search for the rising edge of the home switch. Once found, it will change direction and search for the falling edge of the home switch. The next encoder index in the left direction will be the zero position.

Negative direction search - The axis will search for the falling edge of the home switch. The next encoder index in the left direction will be the zero position.

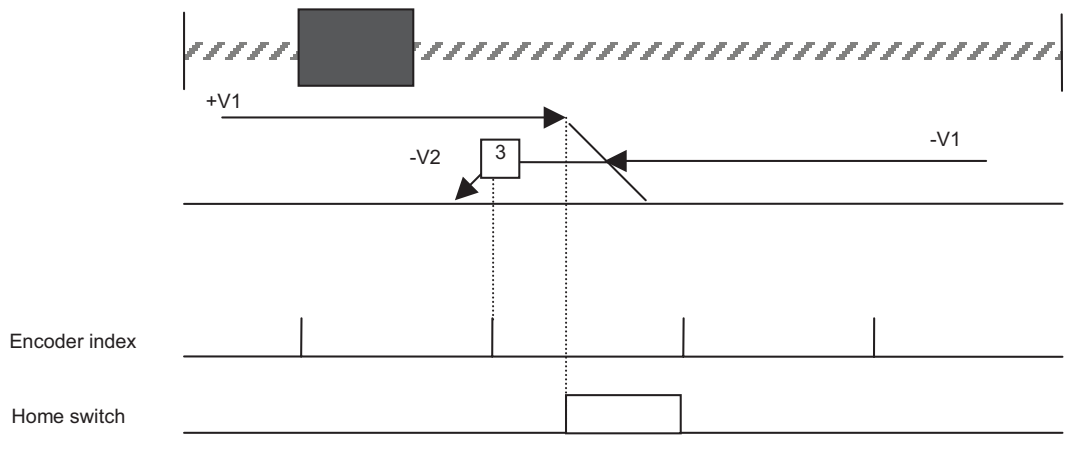

Method 4 - Homing on the home switch (reverse polarity) and the index pulse

Positive direction search - The axis will search for the rising edge of the home switch. The next encoder index in the right direction will be the zero position.

Negative direction search - The axis will search for the falling edge of the home switch. Once found, it will change direction and search for the rising edge of the home switch. The next encoder index in the right direction will be the zero position.

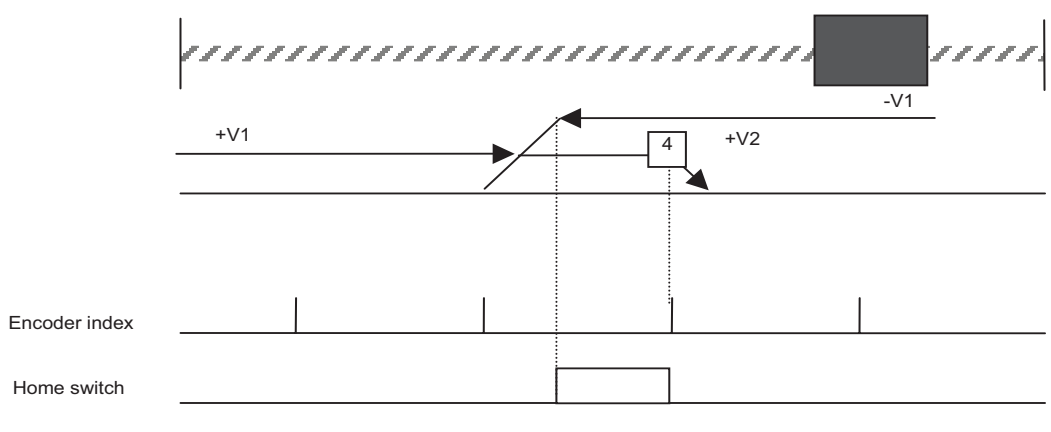

Method 5 - Homing on the home switch and the index pulse

Positive direction search - The axis will search for the falling edge of the home switch. The next encoder index in the right direction will be the zero position.

Negative direction search - The axis will search for the rising edge of the home switch. Once found, it will change direction and search for the falling edge of the home switch. The next encoder index in the right direction will be the zero position.

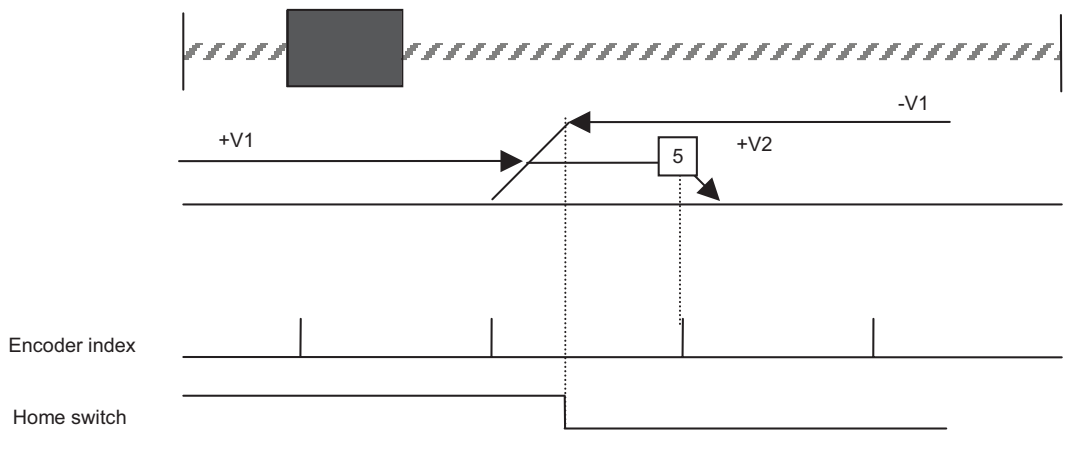

Method 6 - Homing on the home switch (reverse polarity) and the index pulse

Negative direction search - The axis will search for the rising edge of the home switch. The next encoder index in the left direction will be the zero position.

Positive direction search - The axis will search for the falling edge of the home switch. Once found, it will change direction and search for the rising edge of the home switch. The next encoder index in the left direction will be the zero position.

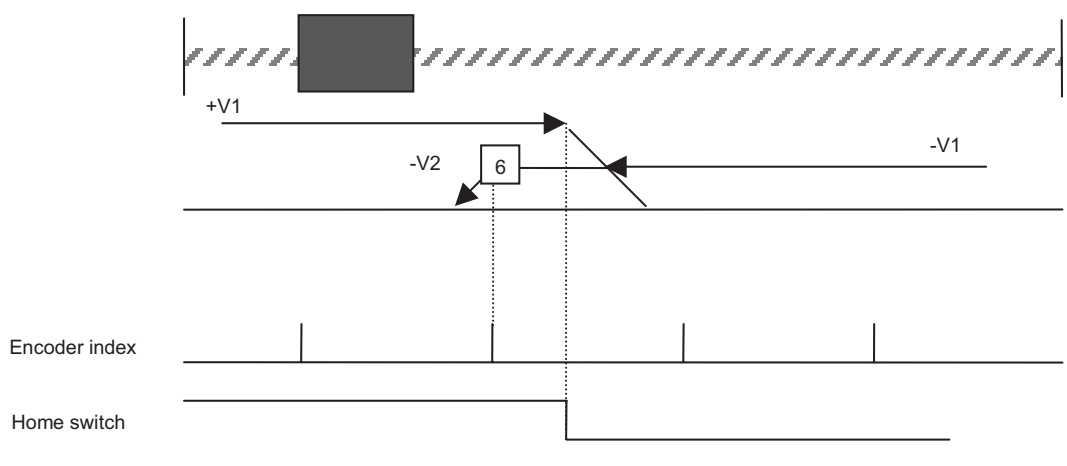

Method 17 - Homing on the negative limit switch, no index pulse

The axis will search for the rising edge of the negative limit switch by speed command in the negative direction. Once found, it will change direction and search for the falling edge of the limit. The falling edge will be the zero position.

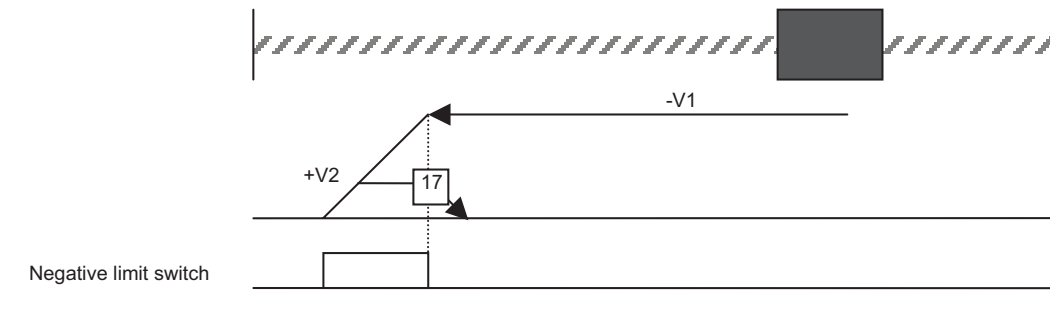

Method 18 - Homing on the positive limit switch, no index pulse

The axis will search for the rising edge of the positive limit switch by speed command in the positive direction. Once found, it will change direction and search for the falling edge of the limit. The falling edge will be the zero position.

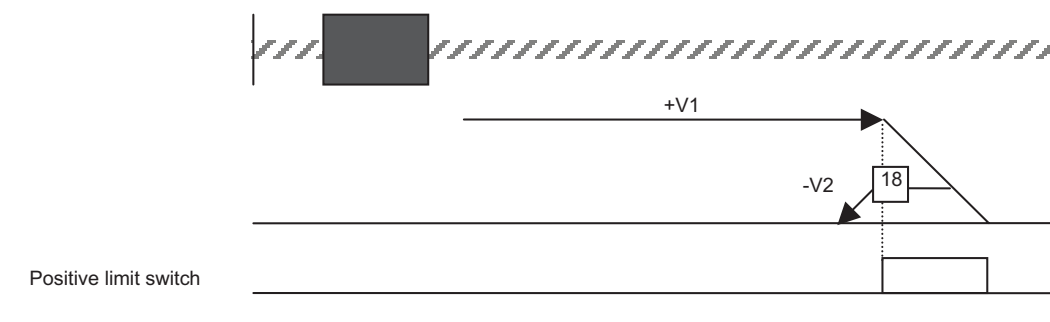

Method 19 - Homing on the home switch, positive direction, no index pulse

The axis will search for the rising edge of the home switch by speed command in the positive direction. Once found, it will change direction and search for the falling edge of the home switch. The falling edge will be the zero position.

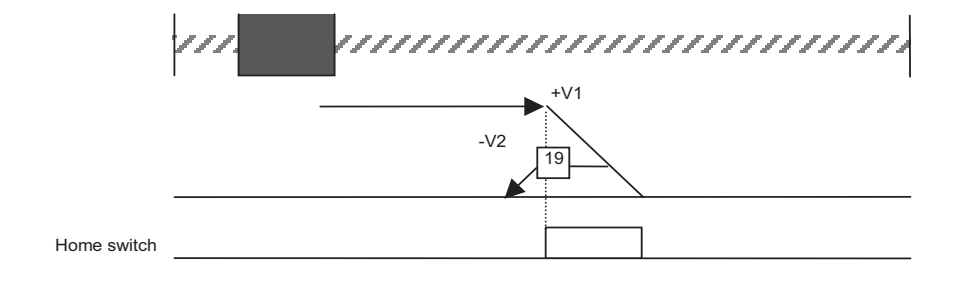

Method 20 - Homing on the home switch (reverse polarity), positive direction, no index pulse

The axis will search for the falling edge of the home switch by speed command in the positive direction. Once found, it will change direction and search for the raising edge of the limit. The raising edge will be the zero position.

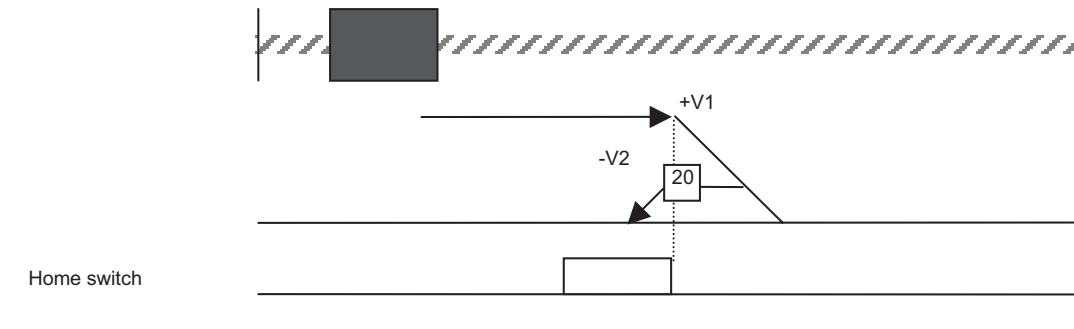

Method 33 - Homing on the index pulse only, negative direction

The axis will search for the encoder index by speed command in the negative direction. The latching of the encoder index position will be the zero position.

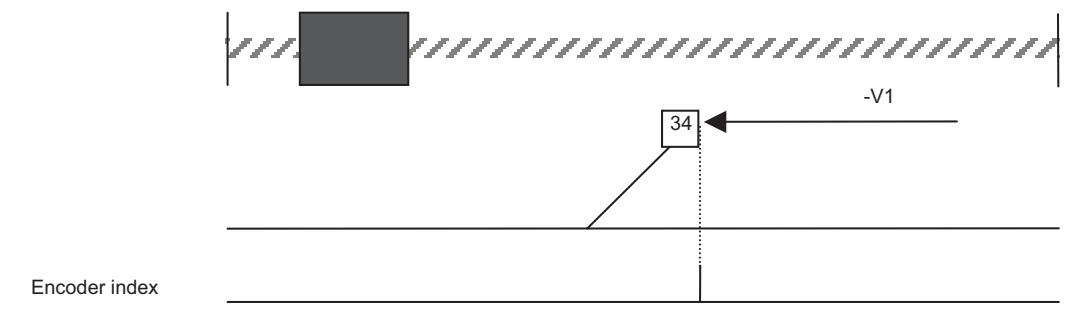

Method 34 - Homing on the index pulse only, positive direction

The axis will search for the encoder index by speed command in the positive direction. The latching of the encoder index position will be the zero position.

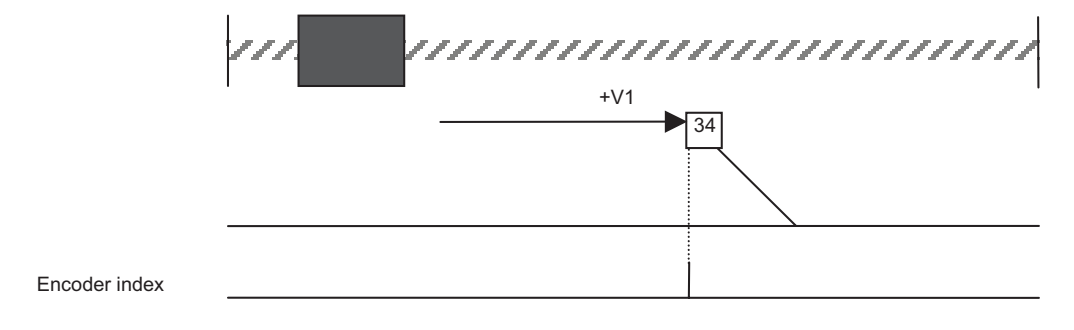

Method 35 - Home on actual position

By selecting this method and raising bit 4 of the control word (object 6040h) the axis actual position will be the zero position.

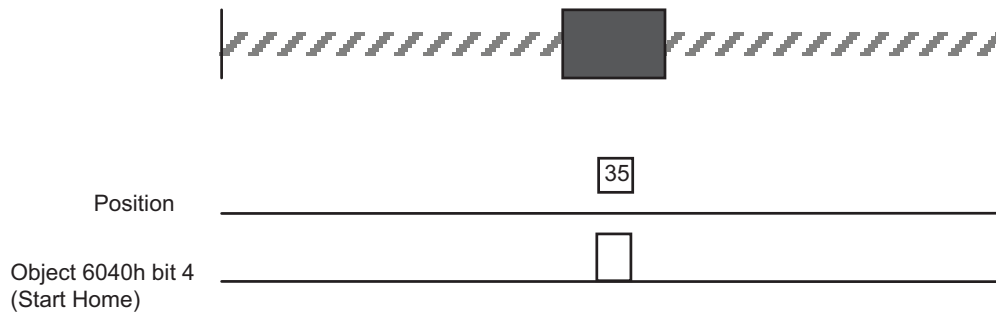

Overview of homing methods

	Method Name	Method Number	SGDV Hardware Pre-assignment
External sensor and index	Negative limit switch and index pulse	1	The inputs that are assigned to these functions are described in the related manuals
	Positive limit switch and index pulse	2	
	Positive (NO) home switch and index pulse	3	
	Positive (NO) home switch (reverse polarity) and index pulse	4	
	Negative (NC) home switch and index pulse	5	
	Negative (NC) home switch (reverse polarity) and index pulse	6	
External sensor only	Negative limit switch (no index)	17	No inputs used
	Positive limit switch (no index)	18	
	Positive home switch	19	
	Positive home switch (reverse polarity)	20	
Index only	Index only, positive direction.	33	No inputs used
	Index only, negative direction.	34	
-	On actual position	35	

9.5 Object 6099h - Homing Speed

Homing Speed

Index	Sub Index	Parameter Name	Data Type	Access Type	Default Value	Category	PDO Mapping
6099h		Homing speed				Optional	Yes
	0h	Number of entries	u8	RO	0x02	Mandatory	
	1h	Approach speed	u32	RW		Mandatory	
	2h	Creep speed	u32	RW		Mandatory	

This object defines the speed during the homing procedure. Depending on the homing method, there are two speeds, the approach and the creep speed. The approach speed is the speed used for searching for the external sensor and the creep speed is the speed used for searching for the zero position.

Value range:

0...4294967295 (0...FFFFFFFFh) [velocity user units]

9.6 Object 609Ah - Homing Acceleration

Index	Sub Index	Parameter Name	Data Type	Access Type	Default Value	Category	PDO Mapping
609Ah	0h	Homing acceleration	u32	RW		Optional	Yes

This object defines the acceleration during the homing procedure.

Value range:

0...4294967295 (0...FFFFFFFFh) [acceleration user units]

Note:

The value of the profile acceleration (object 6083h) and the homing acceleration (object 609Ah) refer to the same SGD V variable. The last acceleration value that was entered will be valid for both objects. If a specific homing acceleration is required, enter the value after the homing procedure has been completed.

10 Profile velocity mode objects

10.1 Mode specific control word

The profile velocity mode uses several bits from the control word (object 6040h) under certain circumstances.

The specific bits of the control word are described in the following table.

Bit	Function	Meaning
4	Reserved	
5	Reserved	
6	Reserved	
8	Halt	=0; execute or continue motion =1; stop motion

10.2 Mode specific status word

Bit	Function	Meaning
10	Target reached	In the event that the driver is not in Halt state (object 6040h bit 8 =0) =0; target velocity not reached. =1; target velocity reached. In the event that the drive is in Halt state (object 6040h bit 8 =1) =0; axis during deceleration. =1; velocity is 0
12	speed	=0; speed is not equal to 0 =1; speed is equal to 0
13	Max slippage error	Not supported

10.3 Object 606Bh - Velocity Demand Value

Index	Sub Index	Parameter Name	Data Type	Access Type	Default Value	Category	PDO Mapping
606Bh	0h	Velocity demand value	i32	RO		Optional	Yes

This object provides the value of the demanded velocity for the closed loop servo cycle of the trajectory generator.

Value range:

-2147483648...+2147483627 (80000000h...7FFFFFFh) [velocity user units].

10.4 Object 606Ch - Velocity Actual Value

Object 606Ch - Velocity Actual Value

Index	Sub Index	Parameter Name	Data Type	Access Type	Default Value	Category	PDO Mapping
606Ch	0h	Velocity actual value	i32	RO		Optional	Yes

This object provides the actual velocity value derived either from the velocity sensor or from the position sensor.

Value range:

-2147483648...+2147483627 (80000000h...7FFFFFFFh) [velocity user units].

10.5 Object 60FFh - Target Velocity

Object 60FFh - Target Velocity

Index	Sub Index	Parameter Name	Data Type	Access Type	Default Value	Category	PDO Mapping
60FFh	0h	Target velocity	I32	RW		Mandatory	Yes

This object defines the target velocity value for the next profile velocity motion. This value is the reference command for the trajectory generator.

Value range:

-2147483648...+2147483627 (80000000h...7FFFFFFFh) [velocity user units].

10.6 Object 6083h - Profile Acceleration

Object 6083h - Profile Acceleration

Index	Sub Index	Parameter Name	Data Type	Access Type	Default Value	Category	PDO Mapping
6083h	0h	Profile acceleration	u32	RW		Mandatory	Yes

The object defines the desired acceleration during the velocity motion profile.

Value range:

-2147483648...+2147483627 (80000000h...7FFFFFFFh) [acceleration user units]

Note:

The value of the profile acceleration (object 6083h) and the homing acceleration (object 609Ah) refer to the same SGD V variable. The last acceleration value that was entered will be valid for both objects. If a specific homing acceleration is required, enter the value after the homing procedure has been completed.

10.7 Object 6084h - Profile Deceleration

Object 6084h - Profile Deceleration

Index	Sub Index	Parameter Name	Data Type	Access Type	Default Value	Category	PDO Mapping
6084h	0h	Profile deceleration	u32	RW		Mandatory	Possible

The object defines the desired deceleration during the velocity motion profile. If this parameter is not used the acceleration value will be taken instead.

Value range:

-2147483648...+2147483627 (80000000h...7FFFFFFh) [acceleration user units]

10.8 Object 6085h - Quick Stop Deceleration

Object 6085h - Quick stop deceleration

Index	Sub Index	Parameter Name	Data Type	Access Type	Default Value	Category	PDO Mapping
6085h	0h	Quick stop deceleration	u32	RW	See Note	Mandatory	Possible

The object defines the quick stop deceleration value that is used when a “Quick Stop” command is given and the quick stop option code (see 605Ah) is set to 2.

Note: The deceleration value is calculated based on the SGDv value at initialization.

Value range:

-2147483648...+2147483627 (80000000h...7FFFFFFh) [acceleration user units]

11 Profile torque mode objects

11.1 Mode specific control word

The profile torque mode uses several bits from the control word (object 6040h) under certain circumstances. The specific bits of the control word are described in the following table.

Bit	Function	Meaning
4	Reserved	
5	Reserved	
6	Reserved	
8	Halt	=0; execute or continue motion =1; stop motion

11.2 Mode specific status word

Bit	Function	Meaning
10	Target torque reached	In the event that the driver is not in Halt state (object 6040h bit 8 =0) =0; target torque not reached. =1; target torque reached. In case that the driver is in Halt state (object 6040h bit 8 =1) =0; axis during deceleration. =1; velocity is 0

11.3 Object 6071h - Target Torque

Object 6071h - Target Torque

Index	Sub Index	Parameter Name	Data Type	Access Type	Default Value	Category	PDO Mapping
6071h	0h	Target torque	i16	RW		Mandatory	Yes

This object defines the target torque value for the next profile torque motion. This value is the reference command for the trajectory generator.

Value range:

-32768...+32767 (8000...7FFFh) [0.1% of rated torque]

11.4 Object 6072h - Maximum Torque

Object 6072h - Maximum Torque

Index	Sub Index	Parameter Name	Data Type	Access Type	Default Value	Category	PDO Mapping
6072h	0h	Maximum torque	i16	RW		Optional	Possible

This object defines the maximum permitted torque for the motor, and is given in 0.001 units of the rated torque.

Note: The default value is the initialization value of the servo drive.

11.5 Object 6074h - Torque Demand

Object 6074h - Maximum Torque

Index	Sub Index	Parameter Name	Data Type	Access Type	Default Value	Category	PDO Mapping
6074h	0h	Torque demand	i16	RO	0	Optional	Possible

This object is the output value of the torque limit function (if the torque control and power-stage function are available). The unit is 0.001 of the rated torque.

11.6 Object 6077h - Torque Actual Value

Object 6077h - Torque Actual Value

Index	Sub Index	Parameter Name	Data Type	Access Type	Default Value	Category	PDO Mapping
6077h	0h	Torque actual value	i16	RO		Mandatory	Yes

This object provides the actual value of the torque. It corresponds to the peak torque of the motor.

Value range:

-32768...+32767 (8000...7FFFh) [0.1% of peak torque]

11.7 Object 6087h - Torque Slope

Object 6087h - Torque Slope

Index	Sub Index	Parameter Name	Data Type	Access Type	Default Value	Category	PDO Mapping
6087h	0h	Torque slope	u32	RW		Mandatory	Yes

This object indicates the configured rate of change of torque.

This value can be changed only when the device is in SWITCH ON DISABLED state machine (object 6040h=0).

Value range:

0...4294967295 (0...FFFFFFFFh) [0.1% of rated torque/sec]

Note: When operating in Profile Torque Mode, the speed limit parameter (Pn480 for linear motors and Pn407 for rotary motors) has always to be specified in an appropriate manner to avoid an unwanted excessive speed behaviour of the drive.

12 Touch probe

The touch probe function records an axis position at the point in time of an input digital signal. Since the position is usually not recorded directly in the PLC, but via an external hardware latch, it is highly accurate and independent of cycle time. The touch probe function controls this mechanism and determines the externally recorded position.

12.1 Object 60B8h - Touch probe function

Index	Sub Index	Parameter Name	Data Type	Access Type	Default Value	Category	PDO Mapping
60B8h	0h	Touch probe function	u16	RW	0	Optional	Yes

This object indicates the configured function of the touch probe.

Value range: Unsigned16

Notes: Bit 0 to 7: for touch probe 1
Bit 8 to 15: for touch probe 2

60B8h Bit2/10 cannot be changed after 60B8h Bit4/12 was set to 1.

Bit No.	Value	Definition
0	0	Switch off touch probe 1
	1	Enable touch probe 1
1	0	Trigger first event
	1	continuous
2	0	Trigger with touch probe 1 input
	1	Trigger with zero signal of position encoder
3	-	Reserved
4	0	Switch off sampling at touch probe 1
	1	Enable sampling at touch probe 1
5	-	not supported
6, 7	0	User-defined (not used)
8	0	Switch off touch probe 2
	1	Enable touch probe 2
9	0	Trigger first event
	1	continuous
10	0	Trigger with touch probe 2 input
	1	Trigger with zero signal of position encoder
11	0	Reserved
12	0	Switch off sampling at touch probe 2
	1	Enable sampling at touch probe 2
13	0	not supported
14, 15	0	User-defined (not used)

12.2 Object 60B9h - Touch probe status

Index	Sub Index	Parameter Name	Data Type	Access Type	Default Value	Category	PDO Mapping
60B9h	0h	Touch probe status	u16	RO	0	Optional	Yes

This object provides the status of the touch probe.

Value range: Unsigned16

Bit No	Value	Definition
0	0	Touch probe 1 is switched off
	1	Touch probe 1 is enabled
1	0	Touch probe 1 no value stored
	1	Touch probe 1 value stored
2	0	not supported
3 to 6	0	Reserved
7	0,1	Shall toggle with every update of Touch probe 1 value stored *1
8	0	Touch probe 2 is switched off
	1	Touch probe 2 is enabled
9	0	Touch probe 2 no value stored
	1	Touch probe 2 value stored
10	0	not supported
11 to 14	0	Reserved
15	0,1	Shall toggle with every update of Touch probe 2 value stored *1

Notes: Bit 0 to 7: for touch probe 1
Bit 8 to 15: for touch probe 2

*1) If the continuous latch is enabled (object 60B8 bit 1 = 1, or bit 9 = 1), bit 7 or bit 15 of object 60B9h is toggled with every stored update of the touch probe value.

12.3 Object 60BAh - Touch probe pos1 pos value

Index	Sub Index	Parameter Name	Data Type	Access Type	Default Value	Category	PDO Mapping
60BAh	0h	Touch probe pos1 pos value	i32	RO	0	Optional	Yes

This object provides the position value of the touch probe 1.
The value shall be given in user-defined position units.

Value range: Integer32

Units: Pos units

12.4 Object 60BCh - Touch probe pos2 pos value

Index	Sub Index	Parameter Name	Data Type	Access Type	Default Value	Category	PDO Mapping
60BCh	0h	Touch probe pos2 pos value	i32	RO	0	Optional	Yes

This object provides the position value of the touch probe 2.
The value shall be given in user-defined position units.

Value range: Integer32

Units: Pos units

13 Interpolated position mode

13.1 General information

The interpolated position mode can control multiple axes in synchronized motion or a single axis that requires a time based interpolated position.

In order to control multi axes movements, the motion controller should calculate the trajectory and divide it into time segments according to the value of the interpolation time period object (60C2h). The interpolation time period object is the time interval between two interpolation points and it sets the resolution of the system.

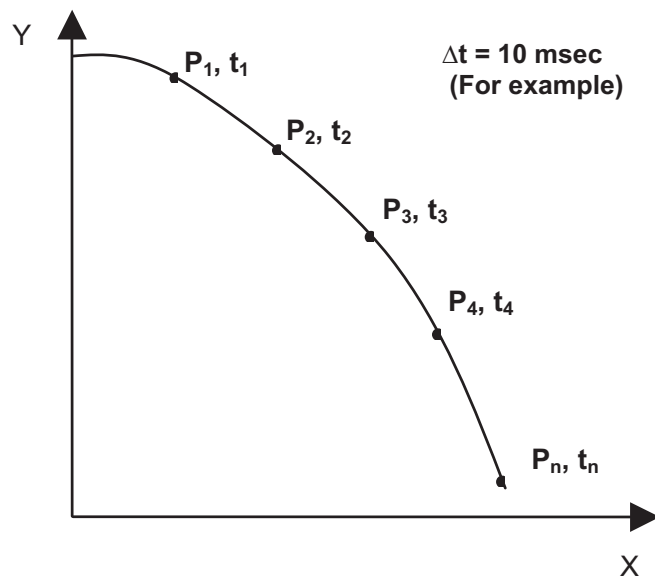

Two-dimensional interpolated curve

Interpolation profile calculation

Point	Interpolation data record		Time [msec]
	X axis	Y axis	
P1	X1	Y1	t1=10
P2	X2	Y2	t2=20
P3	X3	Y3	t3=30
P4	X4	Y4	t4=40
...
Pn	Xn	Yn	tn=nx10

The SGD V-OCB01A interpolates the data points using a linear interpolation method and therefore any interpolation point can be referred to as the set point of the specified time cycle. These set points are transmitted from the controller to the relevant SGD V-OCB01A unit using the interpolation data record object (60C1h). The movement between two given set points will be generated as a profile position motion in absolute values.

The interpolated position mode uses the network's SYNC signal for time coordination between the related SGD V-OCB01A units. The SGD V-OCB01A reduces the jitter of the SYNC between the axes to be less than 2 μsec at 1 Mbps.

In interpolation mode, the state machine "Operation Enabled" is divided into two sub states as shown in the figure below.

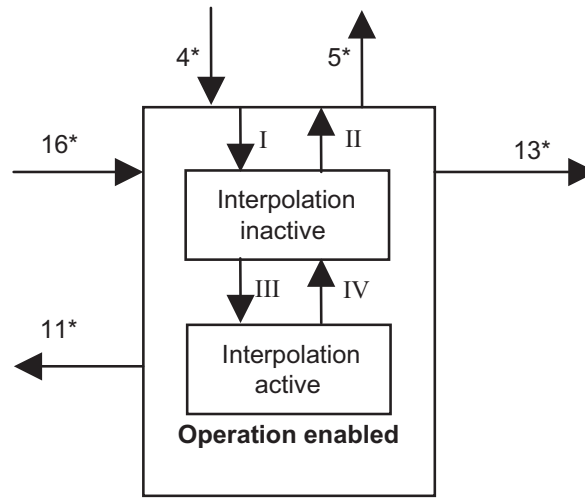

Interpolation mode sub-states

* The number of transitions to/from the Operation Enabled State correspond to the PDS (Power Drive System) transitions described in chapter 6.1.2. The functionality of the sub states is described in the following table.

Functionality of the Interpolation mode sub-states

Sub State	Function	Transitions
Interpolation inactive	The SGD V-OCB01A will accept input data record, and store it. The axis will not move in this sub-state.	I - interpolation mode of operation selected (6060h = 7) II - mode of operation different than interpolation (6060h <> 7)
Interpolation active	The SGD V-OCB01A will accept data record. The axis will move immediately to the next valid set point.	III - 6040h, bit 4, 0 → 1 IV - 6040h, bit 4, 1 → 0

Motion from the interpolated data record can be executed in the following way:

Continuously - one interpolation data record is sent together with the SYNC signal by a synchronous cyclic RPDO that the interpolation data record is mapped into. The drive immediately executes the valid data record if the state machine is interpolation active.

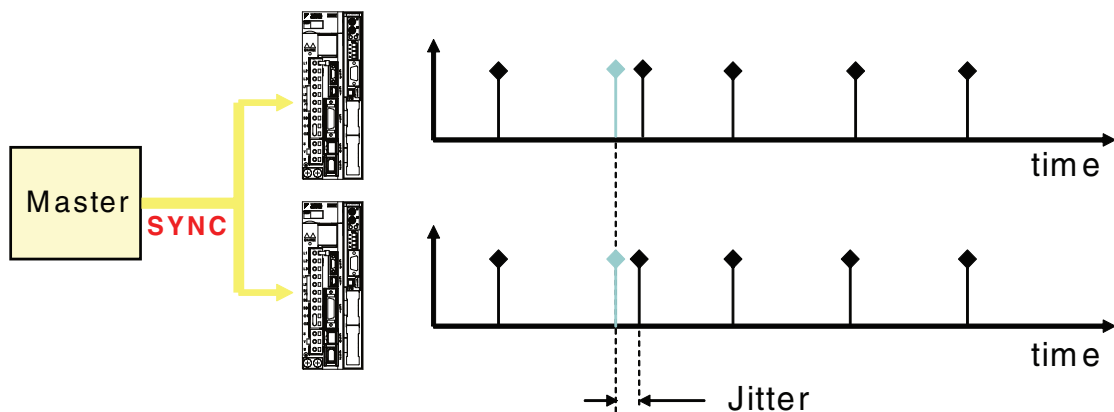

The time synchronization is based on the network's SYNC message, and is ensured to be less than 2 μsec.

13.2 Mode specific control word

The specific bits of the control word are described in the following table:

Bit	Function	Meaning
4	Interpolation mode active/inactive	=0; interpolation mode inactive. The drive will accept new data records and store them in the input buffer. =1; interpolation mode active. The drive will execute the next valid data record in the next SYNC.
5	Reserved	
6	Reserved	
8	Halt	Not supported

13.3 Mode specific status word

The specific bits of the status word are described in the following table.

Bit	Function	Meaning
10	Target reached	=0; target position not yet reached =1; target position reached
12	Interpolation mode active	=0; interpolation mode inactive =1; interpolation mode active

13.4 Object 60C1h - Interpolation Data Record

Object 60C1h - Interpolation Data Record

Index	Sub Index	Parameter Name	Data Type	Access Type	Default Value	Category	PDO Mapping
60C1h		Interpolation data record				Mandatory	
	0h	Number of entries	u8	RO	0x01	Mandatory	
	1h	1st set point	i32	RW		Mandatory	Yes

This object contains the necessary data to perform the interpolated motion. The SGDVOCB01A interpolates the data points using a linear interpolation method and therefore the SGDVOCB01A can refer to the interpolation data record as the new absolute set point.

Value range for sub-index 0h:

1, 1 set-point can be transmitted at a time cycle.

Value range:

-2147483648...+2147483627 (80000000h...7FFFFFFFh) [position user units].

13.5 Object 60C2h - Interpolation Time Period

Object 60C2h - Interpolation Time Period

Index	Sub Index	Parameter Name	Data Type	Access Type	Default Value	Category	PDO Mapping
60C2h		Interpolation time period				Mandatory	
	0h	Number of entries	u8	RO	0x02	Mandatory	
	1h	Interpolation time period value	u32	RW		Mandatory	
	2h	Interpolation time index		const	-3	Mandatory	

This object indicates the configurable time cycle.
The time cycle is given in the following format:

Time cycle = time period value [10 time cycle index sec]

The time units are in milliseconds and therefore the value of the time cycle index (sub index 2) is fixed to -3.

Value range for sub-index 1h:

- Minimum value: 4.
- Maximum value: 16.
- Increments of 1.

Value range for sub-index 2h:

- 3 (fixed value).

13.6 Guidelines for interpolated motion execution

13.6.1 Working in continuous execution:

The following steps are necessary to implement interpolated motion with continuous streaming set points:

1. Start the SYNC signal. The SYNC cycle should be equal to the interpolation time period, 60C2h/1h.
2. Configure a RPDO to be of synchronous cyclic type and map the 1st set point interpolation data record object (60C1h/1h) to it.
3. Set the mode of operation to interpolation mode (object 6060h = 7).
4. Switch to operation enabled state.
5. Initiate motion by switching to interpolation active state by raising bit 4 in the control word (object 6040h, bit 4, 0 → 1).
6. Verify that the mode of operation has changed to interpolation mode by reading the mode of operation display object value (6061h = 7).
7. Start sending the RPDOs containing the next set point for the next time cycle.

14 Inputs and outputs objects

14.1 Object 60FDh - Digital Inputs

Index	Sub Index	Parameter Name	Data Type	Access Type	Default Value	Category	PDO Mapping
60FDh	0h	Digital inputs	u32	RO		Optional	Yes

31-23	22	21	20	19	18	17	16	15-4	3	2	1	0
0	IN6	IN5	IN4	IN3	IN2	IN1	IN0	0	E-stop	Home switch	P-OT	N-OT

This object indicates the state of the digital inputs. The SGD V supports 7 digital inputs. The physical inputs correspond to CN1.40-CN1.46 and can be assigned to logical input as limit switches, an E-stop or a home switch. The binary code of the digital inputs state in object 60FDh is as follows:

Value range:

=0; not active

=1; active

14.2 Object 60FEh - Digital Output

Object 60FEh - Digital Output

Index	Sub Index	Parameter Name	Data Type	Access Type	Default Value	Category	PDO Mapping
60FEh		Digital output				Optional	Yes
	0h	Number of entries	u8	RO	0x02	Mandatory	
	1h	Physical output	u32	RW		Mandatory	
	2h	Output mask	u32	RW	0x1	Optional	

This object commands the digital output state. The SGD V has 4 digital outputs. OUT1-OUT3 are assigned for general use and OUT4 is assigned as an alarm output. The digital outputs correspond to CN1.25 - CN1.30.

Sub-index 1h: set output on/off by sending the binary state as follows:

:

31-20	19	18	17	16-0
N/A	OUT3	OUT2	OUT1	N/A

Value range:

=0; output off

=1; output on

Sub-index 2h: set masking on/off to specific output by sending binary state as follows.

Value range:

=0; masking off

=1; masking on

15 Error handling

15.1 General

EMCY is one of the CANopen services.

The EMCY message CAN-ID is 80h+Node ID. EMCY messages are prioritized immediately after NMT messages, and before any data objects (PDOs and SDOs).

Error messages are generated automatically once an error has occurred. Error messages are only transmitted once for each error, so the error handling should be in order of occurrence.

15.2 Classes

The SGDV-OCB01A errors are divided into classes according to the CiA-301 standard. Some of the classes indicate an error in the SGDV-OCB01A unit or a networking failure and some of them indicate an error in the SGDV, or errors resulting from the use of an incorrect operation command.

Class	Cause of Error	Location	Message Type
CANopen communication error	CAN bus off CAN error passive CAN overrun CAN buffer overflow	SGDV-OCB01A	EMCY message
SDO communication error	SDO protocol error Wrong data received	SGDV-OCB01A	SDO abort transfer
Serial communication error	Serial communication lost Checksum error Serial buffer overflow	SGDV-OCB01A SGDV	EMCY message
Drive errors	Wrong operation Wrong parameter setting	SGDV	EMCY message
Drive warning	Warning about parameters modification	SGDV	EMCY message

15.3 EMCY message format

EMCY message format

COB-ID	DATA							
11 bits	Byte 0 Byte 1	Byte 2	Byte 3	Byte 4	Byte 5	Byte 6	Byte 7	
80h+Node-ID	Error code	Error Register (Object 1001h)	Manufacturer specific additional bytes					
			Additional byte 1	Additional byte 2	Additional byte 3	Additional byte 4	Additional byte 5	
			Sub error code	Error Type: 0 - alarm 1 - warning 2 - fault	SGDV code number	2 hex bytes of Var-ID90		

15.4 Generic error

Error Code	Additional byte					Error	Description and Device Reaction	Error Handling
	1	2	3	4	5			
1000h	0	Error Type (0/1/2)	F1 F2	Var-ID 90		Generic unexpected error	The SGDV-OCB01A has received an unexpected error from the servo drive	Contact Yaskawa Support and report the SGDV error code

15.5 CANopen communication errors

Error Code	Additional byte					Error	Description and Device Reaction	
	1	2	3	4	5			
8110h	1	2	0	0	0	CAN controller overflow The receive message buffer of the CAN controller is full.	CAN message was lost. Any motion will be terminated with profile deceleration.	Reset fault from control word (object 6040h = 80h) or reset communication
8110h	2	2	0	0	0	CAN TX buffer overflow The transmit buffer of the CANopen library is full.	CAN message was lost. Any motion will be terminated with profile deceleration.	Reset fault from control word (object 6040h = 80h) or reset communication
8110h	3	2	0	0	0	CAN RX buffer overflow The receive buffer of the CANopen library is full.	CAN message was lost. Any motion will be terminated with profile deceleration.	Reset fault from control word (object 6040h = 80h) or reset communication
8120h	0	2	0	0	0	CAN error passive The CAN controller has detected communication error and reported error passive.	Any motion will be terminated with profile deceleration.	Reset fault from control word (object 6040h = 80h) or reset communication

Error Code	Additional byte					Error	Description and Device Reaction	
	1	2	3	4	5			
8140h	0	2	0	0	0	CAN recovered from bus-off The CAN controller has detected too many transmit errors and had changed to bus-off state.	Any motion will be terminated with profile deceleration.	Reset fault from control word (object 6040h = 80h) or reset communication. The SGDV-OCB01A will try to recover this error.
8200h	0	2	0	0	0	PDO data The SGDV-OCB01A has received faulty data via PDO.	The faulty data will be ignored.	

15.6 Emergency message

Emergency errors are triggered by internal errors and warnings detected within the servo drive. The manufacturer specific error code 0xFF00h is used for this purpose.

The emergency telegram consists of 8 bytes with data as shown in the table below:

Byte	0	1	2	3	4	5	6	7
Content	Emergency Error Code Code (0xFF00h)		Error register (object1001h)	Reserved	Manufacturer specific Error Field			
Object	603Fh		1001h	-	203Fh			

Manufacturer specific Error Field

Content	Bit	Description	Details
Fault Code	0....15	Error Code	Refer to Error Code Chart
Attribute	16	Alarm/Warning	0: Alarm 1: Warning
	17	Sigma-5/Application Fault	0: Sigma-5 fault 1: CANopen application fault
	18...23	No Effect	Always 0
Reserved	24..31	No Effect	Always 0

15.7 Error code chart

		Byte	0	1	2	3	4	5	6	7							
Emergency Code		Contents	Emergency error code				Error Reg. (object 1001h)	Reserved	Manufacturer specific error field								
		Name					b0 = generic error b1..7 always 0		Reserved	b0=0:alm - b1=0:DCS SV 1:CANopen appl.	Fault code						
5530h	0000 0002 8008h	Read/Write EEPROM error	5	5	3	0	0	0	0	0	0	0	2	8	0	0	8
8100h	0000 0002 8004h	NMT Stop	8	1	0	0	0	0	0	0	0	0	2	8	0	0	4
8120h	0000 0002 8002h	CAN in error passive	8	1	2	0	0	0	0	0	0	0	2	8	0	0	2
8130h	0000 0002 8007h	Heartbeat error	8	1	3	0	0	0	0	0	0	0	2	8	0	0	7
8140h	0000 0002 8001h	Recovered from bus-off	8	1	4	0	0	0	0	0	0	0	2	8	0	0	1
8200h	0000 0003 8006h	Wrong value received via PDO	8	2	0	0	0	0	0	0	0	0	3	8	0	0	6
8210h	0000 0000 0000h	PDO not processed due to length error	8	2	1	0	0	0	0	0	0	0	0	0	0	0	0
8220h	0000 0000 0000h	Length exceeded	8	2	2	0	0	0	0	0	0	0	0	0	0	0	0
FF00h	0000 0000 0A10h	Device error *	F	F	0	0	0	0	0	0	0	0	0	0	A	1	0
FF00h	0000 0000 0A03h	Wrong Node ID * : Address is out of the allowable range	F	F	0	0	0	0	0	0	0	0	0	0	A	0	3
FF00h	0000 0000 0EA0h	Command-Option IF Servo Unit Initial Error *	F	F	0	0	0	0	0	0	0	0	0	0	E	A	0
FF00h	0000 0000 0EA1h	Command-Option IF Memory Check Error *	F	F	0	0	0	0	0	0	0	0	0	0	E	A	1

FF00h	0000 0000 0EA2h	Command-Option IF Servo Synchronization Error *	F	F	0	0	0	0	0	0	0	0	0	0	0	0	0	0	E	A	2
FF00h	0000 0000 0EA3h	Command-Option IF Servo Data Error *	F	F	0	0	0	0	0	0	0	0	0	0	0	0	0	0	E	A	3
FF00h	0000 0002 0007h	Wrong Sync period	F	F	0	0	0	0	0	0	0	0	0	0	2	0	0	0	0	0	7
FF00h	0000 0002 8003h	NMT Reset Comm	F	F	0	0	0	0	0	0	0	0	0	0	2	8	0	0	0	0	3
FF00h	0000 0003 0001h	Motion buffer full warning	F	F	0	0	0	0	0	0	0	0	0	0	3	0	0	0	0	0	1
FF00h	0000 0002 0009h	Abnormal control state	F	F	0	0	0	0	0	0	0	0	0	0	2	0	0	0	0	0	9
FF00h		xxxx-Other Sigma- 5 Alarm and Warning (Refer to Sigma-5 manual) *	F	F	0	0	0	0	0	0	0	0	0	0	0	x	x	x	x	x	x

* These errors are also reported to the SGD amplifier.

15.7.1 Error code chart 1: Errors detected by the CANopen network card

Fault Code (Same as display A.xxx)	Attribute (Bit)		Meaning	Description	Zero Speed Stop	Store EEPROM of servo unit	Operate alarm reset
	16	17					
0x0EA0	0	1	Command-Option IF Servo Unit Initial Error	This alarm is detected when the initial sequence is not completed within 10 s. The timeout period (between the power on and the completion of DPM initial sequence) is provided for both Option Card and Servo Unit. This alarm is not allowed for an "alarm reset", and the sequence is stopped after the alarm is detected.	No	Yes	No
0x0EA1	0	1	Command-Option IF Memory Check Error	The Option Card detects this alarm if there is a "verify" error during the memory check in the DPM initial sequence. This alarm is not allowed for an "alarm reset", and the sequence is stopped after the alarm is detected so that the DPM data exchange will not be carried out.	No	Yes	No
0x0EA2	0	1	Command-Option IF Servo Synchronization Error	After detecting the alarm, the cyclic data except for the WDC is disabled, and the data is enabled back again to be refreshed when the WDC comes back to a normal state (WDC is defined as normal when it is successfully refreshed for 16 consecutive times).	No	Yes	Yes

Fault Code (Same as display A.xxx)	Attribute (Bit)		Meaning	Description	Zero Speed Stop	Store EEPROM of servo unit	Operate alarm reset
	16	17					
0x0EA3	0	1	Command-Option IF Servo Data Error	The Option Card detects this alarm if the checksum of the cyclic data refreshed by the Servo Unit is inappropriate. After detecting the alarm, the cyclic data is disabled, and the data is enabled back again to be refreshed when the WDC comes back to a normal state (WDC is defined as normal when it is successfully refreshed for 16 consecutive times).	No	Yes	Yes
0x0A03	0	1	Node ID setting error	The Node ID address is out of the allowable range (01-7Fh)	No	Yes	Yes
0x0A10	0	1	Device error		No	Yes	No

15.7.2 Error code chart 2: Errors detected by the servo unit

Fault Code (Same as display A.xxx)	Attribute (Bit)		Meaning	Description	Operate alarm reset
	16	17			
0x00xx ...0Dxx	X	0	Alarm/Warning from Sigma-5	Same code of Sigma-5 Alarm/Warning A.xxx	See Sigma-5 manual
0x0E00	0	0	Command-Option IF Option Card Initial Error	This alarm is detected when the initial sequence is not completed within 10 s. The timeout period (between the power on and the completion of DPM initial sequence) is provided for both Network Card and Servo Unit. This alarm is not allowed for an “alarm reset”, and the sequence is stopped after the alarm is detected.	No

Fault Code (Same as display A.xxx)	Attribute (Bit)		Meaning	Description	Operate alarm reset
	16	17			
0x0E02	0	0	Command-Option IF Option Card Synchronization Error	The Servo Unit detects this alarm if the WDC of the cyclic data refreshed by the Network Card is not updated properly. After detecting the alarm, the cyclic data except for the WDC is disabled, and the data is enabled back again to be refreshed when the WDC comes back to a normal state (WDC is defined as normal when it is successfully refreshed for 16 consecutive times).	Yes
0x0E03	0	0	Command-Option IF Option Card Data Error	The Servo Unit detects this alarm if the checksum of the cyclic data refreshed by the network Card is inappropriate. After detecting the alarm, the cyclic data is disabled, and the data is enabled back again to be refreshed when the WDC comes back to a normal state (WDC is defined as normal when it is successfully refreshed for 16 consecutive times).	Yes
0x0E70	0	0	Error of Command- Option Card not Detected	Upon power on, the Servo Unit confirms a Board ID signal output from the Network Card. This alarm is detected if the Servo Unit determines that the Network Card is not connected. After the alarm detection, the DPM data exchange will not be carried out.	No
0x0E73	0	0	Error of Command- Option Card not Supported	Upon power on, the Servo Unit confirms a Board ID signal output from the Network Card. This alarm is detected if “Board ID” or “OpType (network Card ID)” set during “DPM Initial Sequence” is found to be out of supported range.	No
0x0E80	0	0	Error of Command- Option Card not Matching	Upon power on, the Servo Unit confirms a Board ID signal output from the Network Card. This alarm is detected if “OpType (network Card ID)” set during “DPM Initial Sequence” is different from the Board ID obtained upon previous power on. It is to notify that the Network Card has been replaced by another type. After the alarm detection, the DPM data exchange will be continued. This alarm cannot be reset unless “Fn014” in an operation mode is executed.	No

15.7.3 Abort SDO Transfer Protocol

The Abort SDO protocol breaks off SDO transmission and indicates the error that caused the break in transmission through an abort code. This code is encoded as UNSIGNED32 value. The following table shows possible reasons for an abort SDO.

Abort Code	Description
0504 0005h	Out of memory
0601 0001h	Attempt to read a write only object
0601 0002h	Attempt to write a read only object
0602 0000h	Object does not exist in the object dictionary
0604 0041h	Object cannot be mapped to the PDO
0604 0042h	The number and length of the objects to be mapped would exceed PDO length
0604 0043h	General parameter incompatibility reason
0606 0000h	Access failed due to a hardware error
0607 0010h	Data type does not match, length of service parameter does not match
0609 0011h	Sub-index does not exist
0609 0030h	Value range of parameter exceeded (only for write access)
0609 0031h	Value of parameter written too high
0609 0032h	Value of parameter written too low
0609 0036h	Maximum value is less than minimum value
0800 0000h	General error
0800 0020h	Data cannot be transferred or stored to the application
0800 0022h	Data cannot be transferred or stored to the application because of the present device state

The abort codes not listed above are reserved.

15.7.4 Recovery procedure after the interlock circuit is open:

The motor is moving in the profile position mode. CN8 was unplugged before the motor reached its target and HBB appears on the display of the SERVOPACK.

The statusword 6041h = 5618h, this means that the fault bit and the HBB bit are active.

Using the following steps, the motor will be enabled to move again:

- 1 - Plug in the CN8 connector (status word = 1618h)
- 2 - Reset the drive (6040h/0= 80h).
A reset of the drive is a must because the fault bit is active (status word = 1650h).
- 3 - 6040h/0 = 6 (status word = 1631h)
- 4 - 6040h/0 = 7
- 5 - 6040h/0 = 0F
- 6 - 6040h/0 = 1F

After completing the above steps the motor will continue to move to its target.

Specification for HBB status (new) in statusword

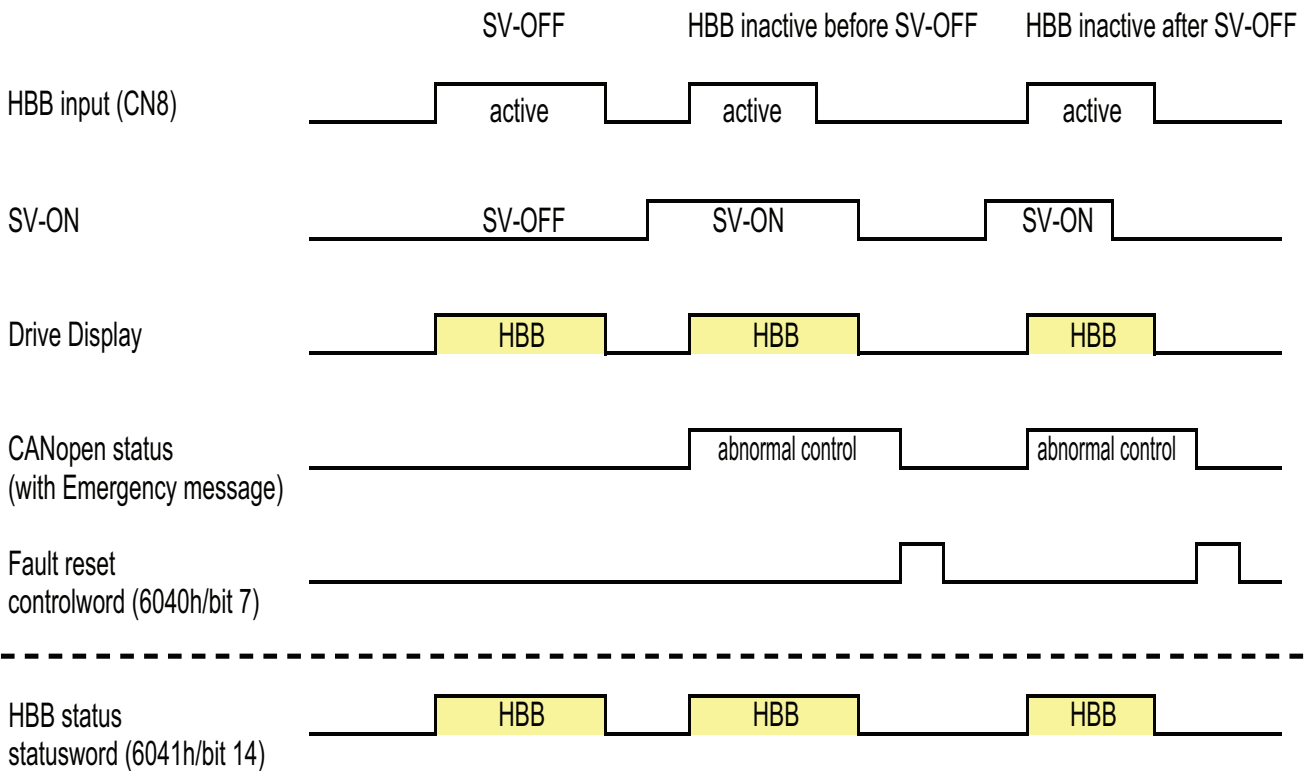

16 Examples

16.1 Homing example

This example describes the homing procedure.

The hardware must be configured appropriately, otherwise the homing procedure will not begin.

For a quick application check, method 33 (Homing on encoder index, positive direction) is recommended since it does not require any I/O pre-assignment and does not exceed more than two motor revolutions during motion.

Note:

The entered values should be set in user units depending on the user application.

Step 1. Perform servo on after power up.

#	Read/Write	Index	Sub Index	Data Type	Value	Description
1	w	0x6040	0	u16	6	Shutdown command
2	w	0x6040	0	u16	0xf	Switch on and enable operation

Step 2. Configure the homing procedure.

#	Read/Write	Index	Sub Index	Data Type	Value	Description
3	w	0x609A	0	u32	Home Acceleration	Acceleration setting
4	w	0x6099	1	u32	100	Setting the approach speed (in [rev/sec] user units)
5	w	0x6099	2	u32	-5	Setting the creep speed (in [rev/sec] user units)
6	w	0x6098	0	i8	Home Method	Homing method setting

Step 3. Set modes of operation to homing mode and start homing procedure

#	Read/Write	Index	Sub Index	Data Type	Value	Description
10	w	0x6060	0	l8	6	Modes of operation setting
11	w	0x6040	0	u16	0x1f	Start homing procedure Motion starts!

Step 4. Verify that the home procedure has ended

#	Read/Write	Index	Sub Index	Data Type	Value	Description
12	r	0x6041	0	u16	x0x1 x1xx xxxx xxxx	Status word bit 10 and 12 rising = home has finished successfully
13	r	0x6064	0	i32	0x0 or, the home offset value when Home off- set has been used.	Actual position in user units.

16.2 Profile position example

This example will describe absolute or relative position movement to a sequence of set points.

Note:

The user units for this example are:

Position user units 1 = 1 revolution

Velocity user units 1 = 1 rev/sec

Acceleration user units 1 = 1 rev/sec²

If the user has set different user units, the entered value should be changed accordingly.

Step 1. Perform servo on after power up.

#	Read/Write	Index	Sub Index	Data Type	Value	Description
1	w	0x6040	0	u16	6	Shutdown command
2	w	0x6040	0	u16	0xf	Switch on and enable operation

Step 2. Configure motion profile.

#	Read/Write	Index	Sub Index	Data Type	Value	Description
3	r	0x607B	1	i32	-2147483648	Checking minimum position limit
4	r	0x607B	2	i32	2147483647	Checking maximum position limit
5	w	0x6081	0	u32	10	Profile constant velocity in [rev/sec] user units
6	w	0x6083	0	u32	10000	Profile acceleration in [rev/sec ²] user units

Step 3a. Configure and operate absolute motion

#	Read/Write	Index	Sub Index	Data Type	Value	Description
7a	w	0x6060	0	i8	1	Modes of operation setting
8a	w	0x607A	0	i32	3	Set the target position to 3 [rev] (positive direction).
9a	w	0x6040	0	u16	0x1f	Set motion active, motor will move to the set point in absolute scale.
10a	w	0x607A	0	i32	15	Set the new set point to 15 [rev] from the origin.
11a	w	0x6040	0	u16	0xf	Bit 4 = 0
12a	w	0x6040	0	u16	0x1f	Bit 4 = 1 moving to the new set point

Step 3b. Configure and operate relative motion.

#	Read/Write	Index	Sub Index	Data Type	Value	Description
7b	w	0x6060	0	i8	1	Modes of operation setting
8b	w	0x607A	0	i32	3	Set the target position to 3 [rev] (positive direction).
9b	w	0x6040	0	u16	0x5f	Set motion active, motor will move to the set point in relative scale.
10b	w	0x607A	0	i32	15	Set the new set point to 15 revolutions from the origin.
11b	w	0x6040	0	u16	0xf	Bit 4 = 0

#	Read/Write	Index	Sub Index	Data Type	Value	Description
12b	w	0x6040	0	u16	0x5f	Bit 4 = 1 Bit 6 = 1 Motor will move the new set point

Step 4. Verify that the homing procedure has ended.

#	Read/Write	Index	Sub Index	Data Type	Value	Description
13	r	0x6041	0	u16	x0xx x1xx xxxx xxxx	Status word bit 10 = 1; target reached
14	r	0x6064	0	i32	15 in case of absolute motion 18 in case of relative motion	Actual position in [rev] user units.

17 Description of data types

17.1 Data types

Several types of data can be used for data entry for CANopen objects. The data type is one of the object definitions defined by the CiA-301 or CiA-402 standards.

The following table describes the data types and range values for each type.

Data types				
Code	Data type	Range	Length	
		Hexadecimal	Decimal	
i8	±Integer 8 bit	80...7Fh	-128 ... +127	1 byte
i16	±Integer 16 bit	8000...7FFFh	-32768...+32767	2 bytes
i32	±Integer 32 bit	80000000h...7FFFFFFFh	-2147483648 ...+2147483627	4 bytes
u8	Unsigned 8 bit	0...FFh	0...255	1 byte
u16	Unsigned 16 bit	0...FFFFh	0...65535	2 bytes
u32	Unsigned 32 bit	0...FFFFFFFFh	0...4294967295	4 bytes
string		Constant		

18 SGD V-OCB01A objects based on EDS

18.1 Description of objects

Index	Sub Index	Parameter name	Data type	Access type	Minimum value	Max value	Default value	Category	PDO mapping
1000h	0h	Device Type	u32	Const.			0x00420192	Mandatory	
1001h	0h	Error Register	u8	RO	0x00	0xFF	0x00	Mandatory	
1005h	0h	COB-ID SYNC	u32	RW			0x00000080	Mandatory	
1008h									
1010h		Store Parameter Field						Optional	
	0h	Number of Entries	u8	RO			0x4	Mandatory	
	1h	Save all Parameters	u32	RW				Mandatory	
1011h		Restore Default Parameters						Optional	
	0h	Number of Entries	u8	RO			0x4	Mandatory	
	1h	Restore all Default Parameters	u32	RW				Mandatory	
1014h	0h	COB-ID EMCY	u32	RO	0x00000081	0x000000FF	0x80+Node-ID	Mandatory	
1016h		Consumer Heartbeat Time						Optional	
	0h	Number of entries	u8	RO	0x1	0x1	0x1	Mandatory	
		Consumer 1 heartbeat time	u32	RW	0x0	0xFFFFFFFF	0x0	Mandatory	
1017h	0h	Producer Heartbeat Time	u16	RW	0x0	0xFFFF	0x0	Mandatory	
1018h		Identity object			0x1	0x4	0x4	Mandatory	
1018h	0h	Number of entries	u8	RO	0x0	0xFFFFFFFF		Mandatory	
	1h	Vendor ID	u32	RO	0x0	0xFFFFFFFF		Optional	
	2h	Product code	u32	RO	0x0	0xFFFFFFFF		Optional	
	3h	Revision number	u32	RO	0x0	0xFFFFFFFF		Optional	
	4h	Serial number	u32	RO	0x0	0xFFFFFFFF		Optional	
1400h		RPDO Communication Parameter 1						Mandatory	
	0h	Number of Entries	u8	RO	0x02	0x05	0x05	Mandatory	
	1h	COB-ID	u32	RW	0x1+Node-ID	0xFFFFFFFF+Node-ID	0x40000200+Node-ID	Mandatory	
	2h	Transmission Type	u8	RW	0x00	0xFF	0xFF	Mandatory	
	3h	Inhibit Time	u16	RW	0x0	0xFFFF	0x0	Optional	

Index	Sub Index	Parameter name	Data type	Access type	Minimum value	Max value	Default value	Category	PDO mapping
1401h		RPDO Communication Parameter 2						Mandatory	
	0h	Number of Entries	u8	RO	0x02	0x05	0x05	Mandatory	
	1h	COB-ID	u32	RW	0x1+Node-ID	0xFFFFFFFF+Node-ID	0x80000300+Node-ID	Mandatory	
	2h	Transmission Type	u8	RW	0x00	0xFF	0xFF	Mandatory	
	3h	Inhibit Time	u16	RW	0x0	0xFFFF	0x0	Optional	
1402h		RPDO Communication Parameter 3						Mandatory	
	0h	Number of Entries	u8	RO	0x02	0x05	0x05	Mandatory	
	1h	COB-ID	u32	RW	0x1+Node-ID	0xFFFFFFFF+Node-ID	0x80000400+Node-ID	Mandatory	
	2h	Transmission Type	u8	RW	0x00	0xFF	0xFF	Mandatory	
	3h	Inhibit Time	u16	RW	0x0	0xFFFF	0x0	Optional	
1403h		RPDO Communication Parameter 4						Mandatory	
	0h	Number of Entries	u8	RO	0x02	0x05	0x05	Mandatory	
	1h	COB-ID	u32	RW	0x1+Node-ID	0xFFFFFFFF+Node-ID	0x80000500+Node-ID	Mandatory	
	2h	Transmission Type	u8	RW	0x00	0xFF	0xFF	Mandatory	
	3h	Inhibit Time	u16	RW	0x0	0xFFFF	0x0	Optional	
1600h		RPDO Mapping Parameter 1						Mandatory	
	0h	Number of Entries	u8	RW	0x0	0x8	0x1	Mandatory	
	1h	Mapping Entry 1	u32	RW	0x0	0xFFFFFFFF	0x60400010	Mandatory	
	2h	Mapping Entry 2	u32	RW	0x0	0xFFFFFFFF	0x0	Optional	
	3h	Mapping Entry 3	u32	RW	0x0	0xFFFFFFFF	0x0	Optional	
	4h	Mapping Entry 4	u32	RW	0x0	0xFFFFFFFF	0x0	Optional	
	5h	Mapping Entry 5	u32	RW	0x0	0xFFFFFFFF	0x0	Optional	
	6h	Mapping Entry 6	u32	RW	0x0	0xFFFFFFFF	0x0	Optional	
	7h	Mapping Entry 7	u32	RW	0x0	0xFFFFFFFF	0x0	Optional	
	8h	Mapping Entry 8	u32	RW	0x0	0xFFFFFFFF	0x0	Optional	
1601h		RPDO Mapping Parameter 2						Mandatory	
	0h	Number of Entries	u8	RW	0x0	0x8	0x2	Mandatory	
	1h	Mapping Entry 1	u32	RW	0x0	0xFFFFFFFF	0x60400010	Mandatory	
	2h	Mapping Entry 2	u32	RW	0x0	0xFFFFFFFF	0x607A0020	Optional	
	3h	Mapping Entry 3	u32	RW	0x0	0xFFFFFFFF	0x607A0020	Optional	

Index	Sub Index	Parameter name	Data type	Access type	Minimum value	Max value	Default value	Category	PDO mapping
	4h	Mapping Entry 4	u32	RW	0x0	0xFFFFFFFF	0x607A0020	Optional	
	5h	Mapping Entry 5	u32	RW	0x0	0xFFFFFFFF	0x607A0020	Optional	
	6h	Mapping Entry 6	u32	RW	0x0	0xFFFFFFFF	0x607A0020	Optional	
	7h	Mapping Entry 7	u32	RW	0x0	0xFFFFFFFF	0x607A0020	Optional	
	8h	Mapping Entry 8	u32	RW	0x0	0xFFFFFFFF	0x607A0020	Optional	
1602h		RPDO Mapping Parameter 3						Mandatory	
	0h	Number of Entries	u8	RW	0x0	0x8	0x2	Mandatory	
	1h	Mapping Entry 1	u32	RW	0x0	0xFFFFFFFF	0x60400010	Mandatory	
	2h	Mapping Entry 2	u32	RW	0x0	0xFFFFFFFF	0x60FF0020	Optional	
	3h	Mapping Entry 3	u32	RW	0x0	0xFFFFFFFF	0x60FF0020	Optional	
	4h	Mapping Entry 4	u32	RW	0x0	0xFFFFFFFF	0x60FF0020	Optional	
	5h	Mapping Entry 5	u32	RW	0x0	0xFFFFFFFF	0x60FF0020	Optional	
	6h	Mapping Entry 6	u32	RW	0x0	0xFFFFFFFF	0x60FF0020	Optional	
	7h	Mapping Entry 7	u32	RW	0x0	0xFFFFFFFF	0x60FF0020	Optional	
	8h	Mapping Entry 8	u32	RW	0x0	0xFFFFFFFF	0x60FF0020	Optional	
1603h		RPDO Mapping Parameter 4						Mandatory	
	0h	Number of Entries	u8	RW	0x0	0x8	0x0	Mandatory	
	1h	Mapping Entry 1	u32	RW	0x0	0xFFFFFFFF	0	Mandatory	
	2h	Mapping Entry 2	u32	RW	0x0	0xFFFFFFFF	0	Optional	
	3h	Mapping Entry 3	u32	RW	0x0	0xFFFFFFFF	0x607A0020	Optional	
	4h	Mapping Entry 4	u32	RW	0x0	0xFFFFFFFF	0x607A0020	Optional	
	5h	Mapping Entry 5	u32	RW	0x0	0xFFFFFFFF	0x607A0020	Optional	
	6h	Mapping Entry 6	u32	RW	0x0	0xFFFFFFFF	0x607A0020	Optional	
	7h	Mapping Entry 7	u32	RW	0x0	0xFFFFFFFF	0x607A0020	Optional	
	8h	Mapping Entry 8	u32	RW	0x0	0xFFFFFFFF	0x607A0020	Optional	
1800h		TPDO Communication Parameter 1						Mandatory	
	0h	Number of Entries	u8	RO	0x02	0x05	0x05	Mandatory	
	1h	COB-ID	u32	RW	0x1+Node-ID	0xFFFFFFFF+Node-ID	0x40000180+Node-ID	Mandatory	
	2h	Transmission Type	u8	RW	0x0	0xFF	0xFF	Mandatory	
	3h	Inhibit Time	u16	RW	0x0	0xFFFF	0x0	Optional	
	4h	Compatibility Entry	u8	RO	0x0	0xFF	0x0	Optional	
	5h	Event Timer	u16	RW	0x0	0xFFFF	0x0	Optional	
1801h		TPDO Communication Parameter 2						Mandatory	

Index	Sub Index	Parameter name	Data type	Access type	Minimum value	Max value	Default value	Category	PDO mapping
	0h	Number of Entries	u8	RO	0x02	0x05	0x05	Mandatory	
	1h	COB-ID	u32	RW	0x1+Node-ID	0xFFFFFFFF+Node-ID	0xC0000280+Node-ID	Mandatory	
	2h	Transmission Type	u8	RW	0x0	0xFF	0xFF	Mandatory	
	3h	Inhibit Time	u16	RW	0x0	0xFFFF	0x0	Optional	
	4h	Compatibility Entry	u8	RO	0x0	0xFF	0x0	Optional	
	5h	Event Timer	u16	RW	0x0	0xFFFF	0x0	Optional	
1802h		TPDO Communication Parameter 3						Mandatory	
	0h	Number of Entries	u8	RO	0x02	0x05	0x05	Mandatory	
	1h	COB-ID	u32	RW	0x1+Node-ID	0xFFFFFFFF+Node-ID	0xC0000380+Node-ID	Mandatory	
	2h	Transmission Type	u8	RW	0x0	0xFF	0xFF	Mandatory	
	3h	Inhibit Time	u16	RW	0x0	0xFFFF	0x0	Optional	
	4h	Compatibility Entry	u8	RO	0x0	0xFF	0x0	Optional	
	5h	Event Timer	u16	RW	0x0	0xFFFF	0x0	Optional	
1803h		TPDO Communication Parameter 4						Mandatory	
	0h	Number of Entries	u8	RO	0x02	0x05	0x05	Mandatory	
	1h	COB-ID	u32	RW	0x1+Node-ID	0xFFFFFFFF+Node-ID	0xC0000480+Node-ID	Mandatory	
	2h	Transmission Type	u8	RW	0x0	0xFF	0xFF	Mandatory	
	3h	Inhibit Time	u16	RW	0x0	0xFFFF	0x0	Optional	
	4h	Compatibility Entry	u8	RO	0x0	0xFF	0x0	Optional	
	5h	Event Timer	u16	RW	0x0	0xFFFF	0x0	Optional	
1A00h		TPDO Mapping Parameter 1						Mandatory	
	0h	Number of Entries	u8	RW	0x00	0x08	0x01	Mandatory	
	1h	Mapping Entry 1	u32	RW	0x0	0xFFFFFFFF	0x60410010	Mandatory	
	2h	Mapping Entry 2	u32	RW	0x00000000	0xFFFFFFFF	0x0	Optional	
	3h	Mapping Entry 3	u32	RW	0x00000000	0xFFFFFFFF	0x0	Optional	
	4h	Mapping Entry 4	u32	RW	0x00000000	0xFFFFFFFF	0x0	Optional	
	5h	Mapping Entry 5	u32	RW	0x00000000	0xFFFFFFFF	0x0	Optional	
	6h	Mapping Entry 6	u32	RW	0x00000000	0xFFFFFFFF	0x0	Optional	
	7h	Mapping Entry 7	u32	RW	0x00000000	0xFFFFFFFF	0x0	Optional	
	8h	Mapping Entry 8	u32	RW	0x00000000	0xFFFFFFFF	0x0	Optional	

Index	Sub Index	Parameter name	Data type	Access type	Minimum value	Max value	Default value	Category	PDO mapping
1A01h		TPDO Mapping Parameter 2						Mandatory	
	0h	Number of Entries	u8	RW	0x00	0x08	0x02	Mandatory	
	1h	Mapping Entry 1	u32	RW	0x0	0xFFFFFFFF	0x60410010	Mandatory	
	2h	Mapping Entry 2	u32	RW	0x00000000	0xFFFFFFFF	0x60640020	Optional	
	3h	Mapping Entry 3	u32	RW	0x00000000	0xFFFFFFFF	0x60640020	Optional	
	4h	Mapping Entry 4	u32	RW	0x00000000	0xFFFFFFFF	0x60640020	Optional	
	5h	Mapping Entry 5	u32	RW	0x00000000	0xFFFFFFFF	0x60640020	Optional	
	6h	Mapping Entry 6	u32	RW	0x00000000	0xFFFFFFFF	0x60640020	Optional	
	7h	Mapping Entry 7	u32	RW	0x00000000	0xFFFFFFFF	0x60640020	Optional	
	8h	Mapping Entry 8	u32	RW	0x00000000	0xFFFFFFFF	0x60640020	Optional	
1A02h		TPDO Mapping Parameter 3						Mandatory	
	0h	Number of Entries	u8	RW	0x00	0x08	0x02	Mandatory	
	1h	Mapping Entry 1	u32	RW	0x0	0xFFFFFFFF	0x60410010	Mandatory	
	2h	Mapping Entry 2	u32	RW	0x00000000	0xFFFFFFFF	0x606C0020	Optional	
	3h	Mapping Entry 3	u32	RW	0x00000000	0xFFFFFFFF	0x606C0020	Optional	
	4h	Mapping Entry 4	u32	RW	0x00000000	0xFFFFFFFF	0x606C0020	Optional	
	5h	Mapping Entry 5	u32	RW	0x00000000	0xFFFFFFFF	0x606C0020	Optional	
	6h	Mapping Entry 6	u32	RW	0x00000000	0xFFFFFFFF	0x606C0020	Optional	
	7h	Mapping Entry 7	u32	RW	0x00000000	0xFFFFFFFF	0x606C0020	Optional	
	8h	Mapping Entry 8	u32	RW	0x00000000	0xFFFFFFFF	0x606C0020	Optional	
1A03h		TPDO Mapping Parameter 4						Mandatory	
	0h	Number of Entries	u8	RW	0x0	0x08	0x0	Mandatory	
	1h	Mapping Entry 1	u32	RW	0x0	0xFFFFFFFF	0x0	Mandatory	
	2h	Mapping Entry 2	u32	RW	0x00000000	0xFFFFFFFF	0x0	Optional	
	2h	Mapping Entry 2	u32	RW	0x00000000	0xFFFFFFFF	0x0	Optional	
	3h	Mapping Entry 3	u32	RW	0x00000000	0xFFFFFFFF	0x0	Optional	
	4h	Mapping Entry 4	u32	RW	0x00000000	0xFFFFFFFF	0x0	Optional	
	5h	Mapping Entry 5	u32	RW	0x00000000	0xFFFFFFFF	0x0	Optional	
	6h	Mapping Entry 6	u32	RW	0x00000000	0xFFFFFFFF	0x0	Optional	
	7h	Mapping Entry 7	u32	RW	0x00000000	0xFFFFFFFF	0x0	Optional	
2004h	0h	Utility servo function	i8	RW	0x0	0x1	0	Optional	No
203fh	0h	Manufacturer error code	u32	RO	0x00000000	0xFFFFFFFF	00000000h	Optional	Yes
2100h		Get Parameter						Optional	
	0h	Number Of Entries	u8	RO	0x00	0xFF		Optional	
	1h	Parameter ID	u16	RW	0x0000	0xFFFF		Optional	
	2h	Parameter value	i16	RO	0x8000	0x7FFF		Optional	

Index	Sub Index	Parameter name	Data type	Access type	Minimum value	Max value	Default value	Category	PDO mapping
2101h		Set Parameter						Optional	
	0h	Number Of Entries	u8	RO	0x00	0xFF		Optional	
	1h	Parameter ID	u16	RW	0x0000	0xFFFF		Optional	
	2h	Parameter value	i16	RW	0x8000	0x7FFF		Optional	
2211h		Read user monitor					0x20	Optional	
	0h	Number of entries	u8	RO	0x00	0xFF		Optional	
	1h	Monitor ID	u8	RW	0x00	0xFF		Optional	
	2h	Monitor value	i32	RO	0x80000000	0x7FFFFFFF		Optional	
2300h	0h	User unit group enable	u8	RW	0x0	0x1		Optional	
2301h		Position user unit							
	0h	Number of Entries	u8	RO	0x00	0xFF	2		
	1h	Numerator	u32	RW	0x00000001	0xFFFFFFFF	1	Mandatory	
	2h	Denominator	u32	RO	0x00000001	0xFFFFFFFF	1	Mandatory	
2302h		Velocity user unit							
	0h	Number of Entries	u8	RO	0x00	0xFF	2		
	1h	Numerator	u32	RW	0x00000001	0xFFFFFFFF	1	Mandatory	
	2h	Denominator	u32	RO	0x00000001	0xFFFFFFFF	1	Mandatory	
2303h		Acceleration user unit							
	0h	Number of Entries	u8	RO	0x00	0xFF	2		
	1h	Numerator	u32	RW	0x00000001	0xFFFFFFFF	1	Mandatory	
	2h	Denominator	u32	RO	0x00000001	0xFFFFFFFF	1	Mandatory	
2400h	0h	Position range limit designation	u8	RW	0x00	0xFF	0	Optional	
2401h	0h	Target_Position_In_Range	i32	RO	0x80000000	0x7FFFFFFF	0	Optional	
2402h		Actual_Position_In_Range	i32	RO	0x80000000	0x7FFFFFFF	0	Optional	
60B8h	0h	Touch probe function	u16	RW			0	Optional	Yes
60B9h	0h	Touch probe status	u16	RO			0	Optional	Yes
60BAh	0h	Touch probe pos1 pos value	i32	RO	0x80000000	0x7FFFFFFF	0	Optional	Yes
60BCh	0h	Touch probe pos2 pos value	i32	RO	0x80000000	0x7FFFFFFF	0	Optional	Yes
603fh	0h	Error code	u16	RO			0000h	Optional	Yes
6040h	0h	Control word	u16	RW				Mandatory	Yes
6041h	0h	Status word	u16	RO				Mandatory	Yes

Index	Sub Index	Parameter name	Data type	Access type	Minimum value	Max value	Default value	Category	PDO mapping
605Ah	0h	Quick Stop option code	i16	RW	1	7	2	Optional	No
605Dh	0h	Halt option code	i16	RW	1	3	1	Optional	No
6060h	0h	Modes of Operation	i8	RWw	0x00	0x07		Optional	Yes
6061h	0h	Modes of Operation Display	i8	RO	0x00	0x0A		Optional	Yes
6062h	0h	Position Demand Value in User Units	i32	RO	0x80000000	0x7FFFFFFF		Optional	
6063h	0h	Position Actual Value	i32	RO	0x80000000	0x7FFFFFFF		Optional	
6064h	0h	Position Actual Value in User Unit	i32	RO	0x80000000	0x7FFFFFFF		Optional	Yes
6067h	0h	Position Window	u32	RW	0x00000000	0xFFFFFFFFE		Optional	
6068h	0h	Position window time	i16	RWw	0x0	0xFFFF		Optional	
606Bh	0h	Velocity Demand Value	i32	RO	0x80000000	0x7FFFFFFF		Optional	
606Ch	0h	Velocity Actual Value	i32	RO	0x80000000	0x7FFFFFFF		Mandatory	Yes
606Dh	0h	Velocity window	i16	RW	0x0	0xFFFF		Optional	
606Eh	0h	Velocity window time	i16	RW	0x0	0xFFFF		Optional	
6071h	0h	Target Torque	i16	RWw	0xFC18	0x03E8		Mandatory	Yes
6072h	0h	Max. torque	i16	RWw	0x0	0xFFFF		Optional	
6074h	0h	Torque demand	i16	RO	0x80000000	0x7FFFFFFF	0	Optional	
6077h	0h	Torque Actual Value	i16	RO	0x8000	0x7FFF		Mandatory	Yes
607Ah	0h	Target Position	i32	RWw	0x80000000	0x7FFFFFFF		Mandatory	Yes
607Bh		Position Range Limit						Optional	
	0h	Number of Entries	u8	RO	0x00	0xFF	0x02	Mandatory	
	1h	Min Position Range Limit	i32	RW	0x80000000	0x7FFFFFFF		Mandatory	
	2h	Max Position Range Limit	i32	RW	0x80000000	0x7FFFFFFF		Mandatory	
607Ch	0h	Home Offset	i32	RW	0x80000000	0x7FFFFFFF	0x00000000	Optional	
607Dh		Software position limit						Optional	
	0h	Highest subindex supported	u8	RO	0x00	0xFF		Mandatory	
	1h	Min software position limit	i32	RW	0x80000000	0x7FFFFFFF		Mandatory	
	2h	Max software position limit	i32	RW	0x80000000	0x7FFFFFFF		Mandatory	
607Fh	0h	Max Profile Velocity	u32	RO	0x0	0x7FFFFFFF		Optional	

Index	Sub Index	Parameter name	Data type	Access type	Minimum value	Max value	Default value	Category	PDO mapping
6081h	0h	Profile Velocity in pp-mode	u32	RWw	0x00000000	0x7FFFFFFF		Mandatory	Yes
6083h	0h	Profile Acceleration	u32	RW	0x0	0x7FFFFFFF		Mandatory	
6084h	0h	Profile deceleration	u32	RW	0x0	0x7FFFFFFF		Mandatory	
6085h	0h	Quick stop deceleration	u32	RW	0x0	0x7FFFFFFF		Mandatory	
6087h	0h	Torque Slope	u32	RW	0x00000000	0xFFFFFFFF		Mandatory	
6098h	0h	Homing Method	i8	RW	0x0	0x23		Mandatory	
6099h		Homing Speeds						Mandatory	
	0h	Number of Entries	u8	RO	0x00	0xFF	0x02	Mandatory	
	1h	Fast Homing Speed	u32	RW	0x00000000	0xFFFFFFFF		Mandatory	
	2h	Slow Homing Speed	u32	RW	0x00000000	0xFFFFFFFF		Mandatory	
609Ah	0h	Homing Acceleration	u32	RW	0x00000000	0xFFFFFFFF		Optional	
60C1h		Interpolated data record						Optional	
	0h	Number of Entries	u8	RO	0x1	0xFE	0x01	Mandatory	
	1h	1st set point	i32	RWw	0x80000000	0x7FFFFFFF		Mandatory	Yes
60C2h		Interpolated time period						Mandatory	
	0h	Number of Entries	u8	RO	0x00	0xFF	0x02	Mandatory	
	1h	Interpolation time period value	u8	RW	0x00	0x04	0x01	Mandatory	
	2h	Interpolation time index		const	F0	FD	FD	Mandatory	
60C5h	0h	Max Acceleration	u32	RO	0x0	0x7FFFFFFF		Optional	
60C6h	0h	Max deceleration	u32	RO	0x0	0x7FFFFFFF		Optional	
60FCh	0h	Position demand internal value	u8	RO	0x80000000	0x7FFFFFFF		Optional	
60FDh	0h	Digital Inputs	u32	RO	0x0	0xFFFFFFFF		Optional	Yes
60FEh		Digital Outputs						Optional	
	0h	Number of Entries	u8	RO	0x00	0x2	0x02	Mandatory	
	1h	Physical Outputs	u32	RWw	0x00000000	0xFFFFFFFF		Mandatory	Yes
	2h	Output Mask	u32	RWw	0x00000000	0xFFFFFFFF		Optional	Yes
60FFh	0h	Target Velocity	i32	RWw	0x80000000	0x7FFFFFFF		Mandatory	Yes
6502h	0h	Supported drive modes	u32	RO	0x00	0xFFFFFFFF		Optional	

Revision History

The revision dates and numbers of the revised manuals are given at the bottom of the back cover.

MANUAL NO. YEG SIEP C720829 20A

Published in Germany January 2010 09-6 $\diamond 3$

└─ Date of publication

└─ Revision number

└─ Date of original publication

Date of Publication	Rev. No.	Section	Revised Contents
June 2009	–		First edition
August 2009	$\diamond 1$	Chapter 1 to 6 & 11	Slightly revised and updated
November 2009	$\diamond 2$	All Chapters	Completely revised and new objects added
January 2010	$\diamond 3$	Chapter 6	Information about Interpolated position mode added in object 6060h and 6061h

AC Servo Drives
 Σ -V Series
USER'S MANUAL

CANopen Network Module

European headquarters

YASKAWA ELECTRIC EUROPE GmbH

Hauptstraße 185, 65760 Eschborn, Germany
Phone: +49 (0) 6196-569-300 Fax: +49 (0) 6196-569-398

YASKAWA ENGINEERING EUROPE GmbH

Hauptstraße 185, 65760 Eschborn, Germany
Phone: +49 (0) 6196-569-520 Fax: +49 (0) 6196-888-598

Manufacturing facility

YASKAWA ELECTRIC UK LTD.

1 Hunt Hill, Orchardton Woods, Cumbernauld, G68 9LF, United Kingdom
Phone: +44 (0) 1236-735000 Fax: +44 (0) 1236-458182



In the event that the end user of this product is to be the military and said product is to be employed in any weapons systems or the manufacture thereof, the export will fall under the relevant regulations as stipulated in the Foreign Exchange and Foreign Trade Regulations. Therefore, be sure to follow all procedures and submit all relevant documentation according to any and all rules, regulations and laws that may apply.

Specifications are subject to change without notice for ongoing product modifications and improvements.

© 2009 YASKAWA ELECTRIC EUROPE GmbH. All rights reserved.

MANUAL NO. YEG SIEP C720829 20A

Published in Germany January 2010 09-6 -0