

Chapter 1 EasyBuilder Pro Installation and Startup Guide.....	9
1.1 EasyBuilder Pro Installation	9
1.2 Steps to Install EasyBuilder Pro	10
Chapter 2 Project Manager Operations.....	16
2.1 HMI IP, Password	17
2.2 Utility	18
2.2.1 Build Download Data for Saving in CF/SD Card or USB Disk.....	18
2.2.2 Steps to Download Project to HMI via USB or CF/SD Card.....	18
2.3 Transfer.....	19
2.3.1 Download	19
2.3.2 Upload.....	20
2.4 Simulation	21
2.4.1 Off-line Simulation/On-line Simulation	21
2.5 Pass-Throug81Bh	23
Chapter 3 Create an EasyBuilder Pro Project.....	24
3.1 Create a New Project.....	24
3.2 Save and Compile the Project.....	26
3.3 Off-line and On-line Simulation	27
3.4 Download the Project to HMI	28
Chapter 4 Hardware Settings	33
4.1 I/O Ports of HMI	33
4.2 HMI System Settings.....	34
4.2.1 System Reset.....	34
4.2.2 System Toolbar.....	35
4.2.3 System Information	36
4.2.4 System Setting.....	36
Chapter 5 System Parameter Settings	40
5.1 Device	41
5.1.1 How to Control a Local PLC.....	42
5.1.2 How to Control a Remote PLC.....	47
5.1.3 How to Control a Remote HMI	49
5.2 Model	51
5.3 General	55
5.4 System Setting	58
5.5 Security	61
5.6 Font.....	64
5.7 Extended Memory	66
5.8 Printer/Backup Server	68

Chapter 6 Window Operations	70
6.1 Window Types.....	70
6.1.1 Base Window	70
6.1.2 Fast Selection Window.....	71
6.1.3 Common Window.....	72
6.1.4 System Message Window.....	73
6.2 Create, Set, and Delete a Window.....	75
6.2.1 Creating and Setting a Window.....	75
6.2.2 Open, Close and Delete a Window	78
Chapter 7 Event Log	79
7.1 Event Log Management	79
7.1.1 Excel Editing	80
7.2 Create a New Event Log	81
7.2.1 Alarm (Event) Log General Settings	81
7.2.2 Alarm (Event) Log Message Settings.....	83
7.3 Event Log Relevant Registers.....	85
Chapter 8 Data Sampling	86
8.1 Data Sampling Management.....	86
8.2 Create a New Data Sampling.....	87
8.3 System Registers Relevant to Data Sampling.....	91
Chapter 9 Object General Properties	92
9.1 Selecting PLC	92
9.1.1 Setting the Reading and Writing Address	92
9.2 Using Shape Library and Picture Library.....	95
9.2.1 Settings of Shape Library.....	96
9.2.2 Settings of Picture Library.....	99
9.3 Setting Text Content	101
9.4 Adjusting Profile Size	106
9.5 Variables of Station Number	107
9.6 Broadcast Station Number	109
Chapter 10 Security	110
10.1 User Password and Operable Object Classes	110
10.2 Object Security Settings.....	111
10.3 Setting Example.....	112
Chapter 11 Index Register	115
11.1 Introduction	115
11.2 Examples of Index Register	116
Chapter 12 Keyboard Design and Usage.....	119

12.1 Steps to Design a Pop-up Keyboard	120
12.2 Steps to Design a Keyboard with Direct Window	122
12.3 Steps to Design a Fixed Keyboard on Screen	123
12.4 Steps to Design a UNICODE Keyboard	124
Chapter 13 Objects	125
13.1 Bit Lamp	125
13.2 Word Lamp.....	128
13.3 Set Bit	133
13.4 Set Word	137
13.5 Function Key	145
13.6 Toggle Switch.....	152
13.7 Multi-State Switch	155
13.8 Slider.....	159
13.9 Numeric Input and Numeric Display	163
13.10 ASCII Input and ASCII Display.....	175
13.11 Indirect Window.....	180
13.12 Direct Window	185
13.13 Moving Shape	189
13.14 Animation	195
13.15 Bar Graph.....	200
13.16 Meter Display	208
13.17 Trend Display	216
13.18 History Data Display.....	227
13.19 Data Block Display	235
13.20 XY Plot.....	248
13.21 Alarm Bar and Alarm Display	262
13.22 Event Display	266
13.23 Data Transfer (Trigger-based).....	275
13.24 Backup	278
13.25 Media Player	285
13.26 Data Transfer (Time-based).....	297
13.27 PLC Control.....	301
13.28 Schedule	308
13.29 Option List.....	329
13.30 Timer.....	336
13.31 Video In.....	341
13.32 System Message.....	345
Chapter 14 Shape Library and Picture Library	347

14.1 Creating Shape Library	347
14.2 Creating Picture Library	354
Chapter 15 Label Library and Multi-Language Usage	361
15.1 Introduction	361
15.2 Building Label Library.....	362
15.3 Setting Label Font	363
15.4 Using Label Library	364
15.5 Settings of Multi-Language (System Register LW-9134)	365
Chapter 16 Address Tag Library	367
16.1 Creating Address Tag Library	367
16.2 Using Address Tag Library	369
Chapter 17 Transferring Recipe Data	370
17.1 Updating Recipe Data with Ethernet or USB cable	371
17.2 Updating Recipe Data with CF/SD Card or USB Disk.....	372
17.3 Transferring Recipe Data	373
17.4 Saving Recipe Data Automatically	373
Chapter 18 Macro Reference	374
18.1 Instructions to the Macro Editor.....	374
18.2 Macro Construction	385
18.3 Syntax	386
18.3.1 Constants and Variables.....	386
18.3.2 Operators	389
18.4 Statement.....	392
18.4.1 Definition Statement.....	392
18.4.2 Assignment Statement.....	392
18.4.3 Logical Statements	392
18.4.4 Selective Statements	394
18.4.5 Reiterative Statements.....	396
18.5 Function Blocks.....	399
18.6 Build-In Function Block	402
18.6.1 Mathematical Functions	402
18.6.2 Data Transformation	408
18.6.3 Data Manipulation	413
18.6.4 Bit Transformation.....	416
18.6.5 Communication	418
18.6.6 String Operation Functions	434
18.6.7 Miscellaneous	460
18.7 How to Create and Execute a Macro	467

18.7.1 How to Create a Macro	467
18.7.2 Execute a Macro	472
18.8 User Defined Macro Function.....	473
18.8.1 Import Function Library File	474
18.8.2 How to Use Macro Function Library	476
18.8.3 Function Library Management Interface	478
18.9 Some Notes about Using the Macro	485
18.10 Use the Free Protocol to Control a Device	486
18.11 Compiler Error Message	492
18.12 Sample Macro Code	499
18.13 Macro TRACE Function	504
18.14 The Usage of String Operation Functions	513
18.15 Macro Password Protection	525
Chapter 19 Set HMI as a MODBUS Server.....	527
19.1 Setting HMI as MODBUS Device	527
19.1.1 Creating a MODBUS Server	527
19.1.2 Read from / Write to MODBUS Server.....	530
19.2 Changing the Station Number of a MODBUS Server in Runtime.....	533
19.3 About MODBUS Address Type.....	534
Chapter 20 How to Connect a Barcode Device.....	535
20.1 How to Connect a Barcode Device	535
Chapter 21 Ethernet Communication and Multi-HMI Connection.....	539
21.1 HMI to HMI Communication	540
21.2 PC to HMI Communication.....	541
21.3 Operate the PLC Connected with Other HMI	542
Chapter 22 System Reserved Words / Bits	543
22.1 The Address Ranges of Local HMI Memory	544
22.1.1 Bits.....	544
22.1.2 Words.....	545
22.2 HMI Time	546
22.3 User Name and Password	547
22.4 Data Sampling.....	548
22.5 Event Log.....	550
22.6 HMI Hardware Operation	552
22.7 Local HMI Network Information.....	553
22.8 Recipe and Extended Memory	554
22.9 Storage Space Management.....	556
22.10 Touch Position	557

22.11 Station Number Variables	558
22.12 Index Register	559
22.13 MTP File Information	560
22.14 MODBUS Server Communication	561
22.15 Communication Parameters Settings	563
22.16 Communication Status with PLC (COM)	566
22.17 Communication Status with PLC (Ethernet)	568
22.18 Communication Status with PLC (USB)	572
22.19 Communication Status with Remote HMI	573
22.20 Communication Status with Remote PLC	579
22.21 Communication Error Messages & No. of Pending Cmd.	582
22.22 Miscellaneous Functions	583
22.23 Remote Print/Backup Server	585
22.24 EasyAccess	586
22.25 Pass-Through Settings	587
22.26 Disable PLC No Response Dialog Box	588
22.27 HMI and Project Key	589
22.28 Fast Selection Window Control	590
22.29 Input Object Function	591
22.30 Local/Remote Operation Restrictions	592
Chapter 23 HMI Supported Printers	593
23.1 The Supported Printer Types	593
23.2 How to Add a New Printer and Start Printing	596
23.2.1 Add Printer Type	596
23.2.2 Start Printing	597
Chapter 24 Recipe Editor	598
24.1 Introduction	598
24.2 Recipe Editor Setting	598
Chapter 25 EasyConverter	601
25.1 How to Export to Excel	601
25.2 How to Use Scaling Function	603
25.3 How to Use Multi-File Conversion	605
Chapter 26 EasyPrinter	606
26.1 Using EasyPrinter as a Printer Server	607
26.1.1 Setup Procedure in EasyPrinter	607
26.1.2 Setup Procedure in EasyBuilder8000	608
26.2 Using EasyPrinter as a Backup Server	611
26.2.1 Setup Procedure in EasyPrinter	611

26.2.2 Setup Procedure in EasyBuilder8000	612
26.3 EasyPrinter Operation Guide	615
26.3.1 Appearance.....	615
26.3.2 Operation Guide.....	616
26.4 Convert Batch File.....	622
26.4.1 The Default Convert Batch File	622
26.4.2 Specialized Criteria	623
26.4.3 The Format of a Convert Batch File	624
26.4.4 The Order of Examining Criteria	625
Chapter 27 EasySimulator	626
27.1 Prepare Needed Files	626
27.2 Modify the Content of “xob_pos.def”	628
Chapter 28 Multi-HMI Intercommunication (Master-Slave Mode).....	629
28.1 How to Create a Project of Master HMI.....	630
28.2 How to Create a Project of Slave HMI.....	631
28.3 How to Connect with MT500 Project of Slave HMI.....	634
Chapter 29 Pass-Through Function	637
29.1 Ethernet Mode.....	638
29.1.1 How to Change the Virtual Serial Port	639
29.1.2 How to Use Ethernet Mode	642
29.2 COM Port Mode	644
29.2.1 Settings of COM Port Mode	644
29.2.2 HMI Work Mode	646
29.3 Using System Reserved Addresses to Enable Pass-Through Function.....	650
Chapter 30 Project Protection	651
30.1 XOB Password.....	652
30.2 Decompilation is Prohibited.....	653
30.3 Disable HMI Upload Function [LB-9033].....	654
30.4 Project Key.....	655
30.5 Project Password (MTP file).....	656
Chapter 31 Memory Map Communication.....	657
Chapter 32 FTP Server Application.....	667
32.1 Login FTP Server.....	667
32.2 Backup History Data and Update Recipe Data	669
Chapter 33 EasyDiagnoser	671
33.1 Overview and Configuration.....	671
33.2 EasyDiagnoser Settings.....	674
33.3 Error Code	681

33.4 Save As.....	682
33.5 Window Adjustment	683
Chapter 34 AB EtherNet/IP Free Tag Names	684
34.1 Import User-Defined AB Tag to EB8000	685
34.2 Adding New Data Type	687
34.3 Paste.....	690
34.4 Miscellaneous	693
34.5 Module-Defined.....	694

Chapter 1 EasyBuilder Pro Installation and Startup Guide

1.1 EasyBuilder Pro Installation

Software:

Download EasyBuilder Pro configuration software from EasyBuilder Pro CD or visiting Weintek Labs, Inc.'s website at <http://www.weintek.com> to obtain all software versions available (including Simplified Chinese, Traditional Chinese, English, Italian, Korean, Spanish, Russian, and French version) and latest upgraded files.

Hardware Requirements (Recommended):

CPU: INTEL Pentium II or higher

Memory: 256MB or higher

Hard Disk: 2.5GB or higher (Disc space available at least 500MB)

CD-ROM: 4X or higher

Display: 256 color SVGA with 1024 x 768 resolution or greater

Keyboard and Mouse

Ethernet: for project downloading/uploading

USB Port 2.0: for project downloading/uploading

RS-232 COM: At least one available RS-232 serial port required for on-line simulation

Printer

Operating System:

Windows XP / Windows Vista / Windows 7.

1.2 Steps to Install EasyBuilder Pro

1. Installing EasyBuilder Pro:

Put the EasyBuilder Pro Installation CD into the CD drive. The computer will run the program automatically and bring up a screen showing an area to click to begin the EasyBuilder Pro installation. If the auto-run sequence does not start, browse the CD, and find the root directory of **[Autorun.exe]** manually. The installation screen is shown below.



2. Click **[Install]**, users will see the window below, select the language and click **[Next]** following the installation instructions.





3. Users will be asked if they would like to remove the old versions of EasyBuilder 8000. Please tick those should be removed and click **[Next]** to continue.



4. Designate a new folder for EasyBuilder Pro installation or choose the folder recommended and then click **[Next]**.



6. Users will be enquired if there are any additional tasks to be done. For example: **[Create a desktop icon]**. Tick it if needed then click **[Next]** to continue.



7. At this moment all the settings are done. Please check if they are all correct. If any changes need to be made, click **[Back]** or click **[Install]** to start installing.



8. Installation processing.

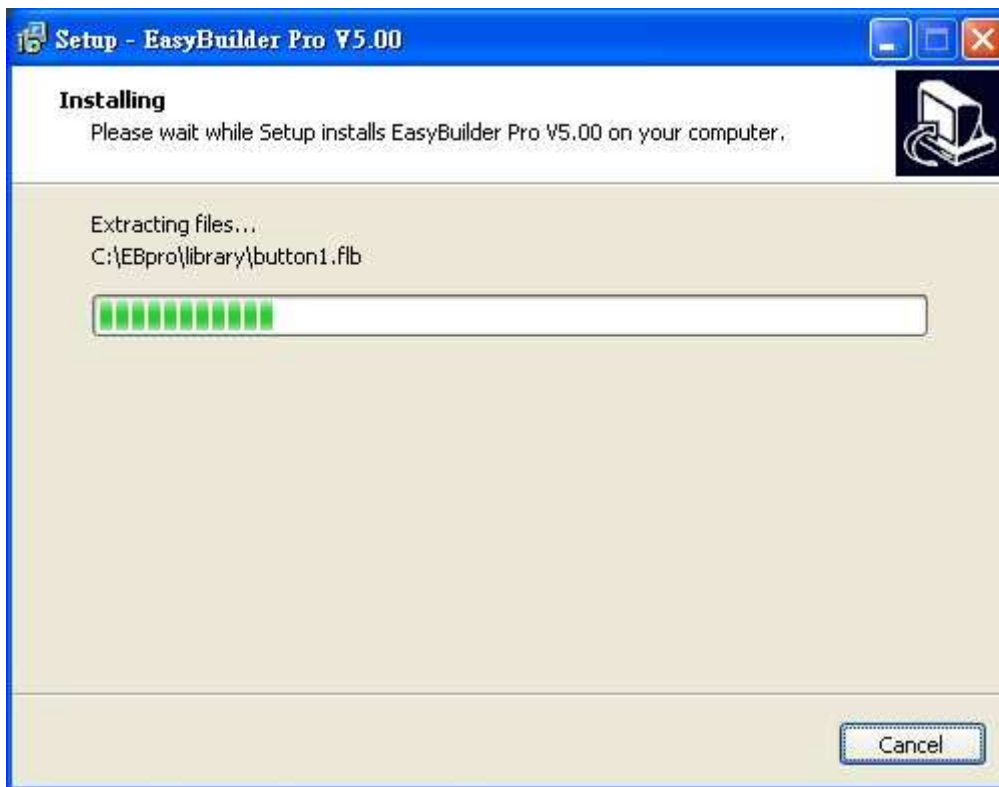











9. Click **[Finish]** to complete the installation.



10. Start EasyBuilder Pro project from menu **[Start] / [All Programs] / [EBpro]**.



The description of each item in EasyBuilder Pro menu:

Installed file	Description
 AB Data Type Editor	Support AB TAG mechanism and improve the flexibility of an object in read/write.
 EasyBuilder8000	EasyBuilder Pro editing software.
 EasyConverter	Conversion tool for Data Sampling and Event Log.
 EasyDiagnoser	Tool for analyzing and detecting connection between HMI and PLC.
 EasyPrinter	Tool for saving hardcopy or backup data is individually downloadable even without full application.
 EasySimulator	Upon completion of project programming, you can execute Online Simulation on PC by directly connect with PLC or Offline Simulation on PC without connecting PLC.
 Project Manager	EasyBuilder Pro project management.
 RecipeEditor	Tool for setting format of Recipe data. Users can open Recipe data or data in External Memory here.
 ReleaseNote	Notes for EasyBuilder Pro version and latest information.
 EasyAddressViewer	Review the register range of device types for each PLC supported.



■ HMI i Series support downloading/uploading project via USB cable. After installing EasyBuilder Pro, Please go to [Computer Management] / [Device Manager] to check if USB driver is also installed, if not, please refer to [installation steps](#) to manually install.

Chapter 2 Project Manager Operations

After installing EasyBuilder Pro software, double click on **[Project Manager]** shortcut. The Project Manager is a software shell for launching several utilities. Some functions are duplicated in the EasyBuilder Pro project editing program. Project Manager can operate as a stand-alone program.

Click the buttons on the dialog box for detail.

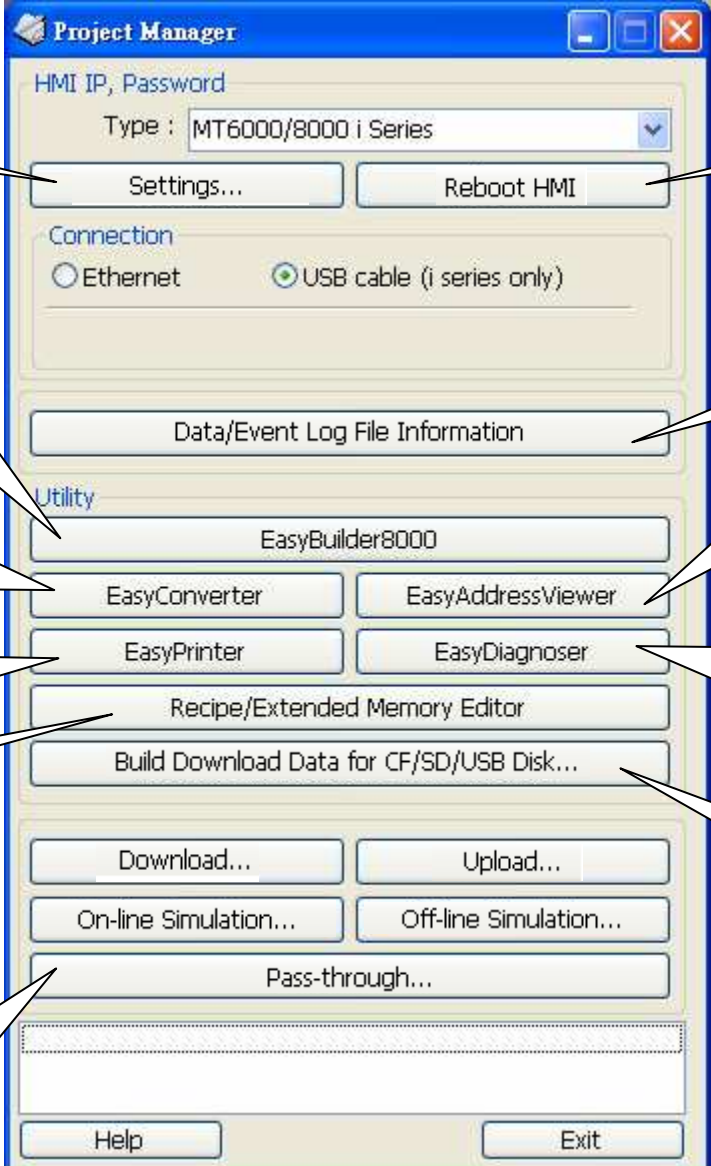

The screenshot shows the 'Project Manager' dialog box with the following sections and callouts:

- HMI IP, Password** section:
 - Settings...**: When operating HMI, designate Password first.
 - Reboot HMI**: After rebooting, everything returns to the startup condition.
- Connection** section:
 - Ethernet** / **USB cable (i series only)**: Connect via USB cable or Ethernet to check the HMI history files information.
- Data/Event Log File Information** section:
 - Data/Event Log File Information**: Review the register range of device types of supported PLC.
- Utility** section:
 - EasyBuilder8000**: Conversion tool for Data Sampling/Event Log.
 - EasyConverter**: Remote printer/backup server.
 - EasyAddressViewer**: Tool for analyzing connection between HMI and PLC.
 - EasyPrinter**: Remote printer/backup server.
 - EasyDiagnoser**: Tool for analyzing connection between HMI and PLC.
 - Recipe/Extended Memory Editor**: Memory format conversion and data editing.
 - Build Download Data for CF/SD/USB Disk...**: Build data for downloading to HMI via CF/SD/USB.
 - Download...** / **Upload...**: Build data for downloading to HMI via CF/SD/USB.
 - On-line Simulation...** / **Off-line Simulation...**: Build data for downloading to HMI via CF/SD/USB.
 - Pass-through...**: Build data for downloading to HMI via CF/SD/USB.
- Help** / **Exit** buttons: Allow PC applications to connect PLC via HMI.

2.1 HMI IP, Password

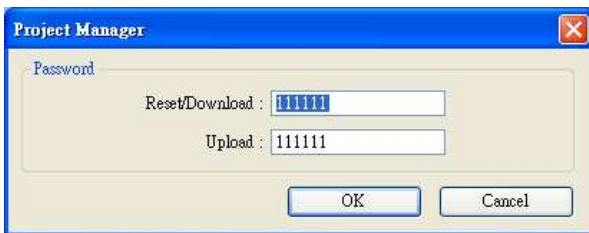

[Settings]

When operating HMI via Ethernet or USB cable, users need to designate the password for HMI to protect against unauthorized access.

[Reset / Download] functions share a set of password while **[Upload]** function uses another set.



Be sure to record any password change, otherwise, while resetting password to default, the project and data on HMI will be completely erased.

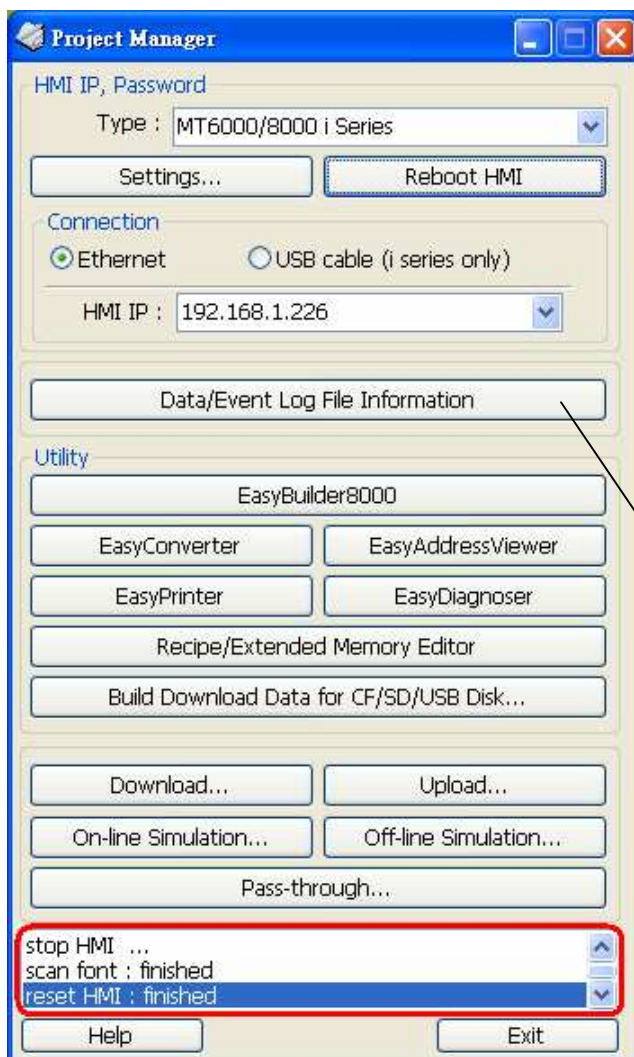

[Reboot HMI]

There are certain situations that the HMI should reboot, for example, when updating the files in it. Users don't need to cut power while rebooting. After rebooting, everything returns to the conditions of startup. Set the correct IP address when operating HMI via Ethernet.

[Data/Event Log File Information]

After setting, connect with HMI to check the number of history files in HMI

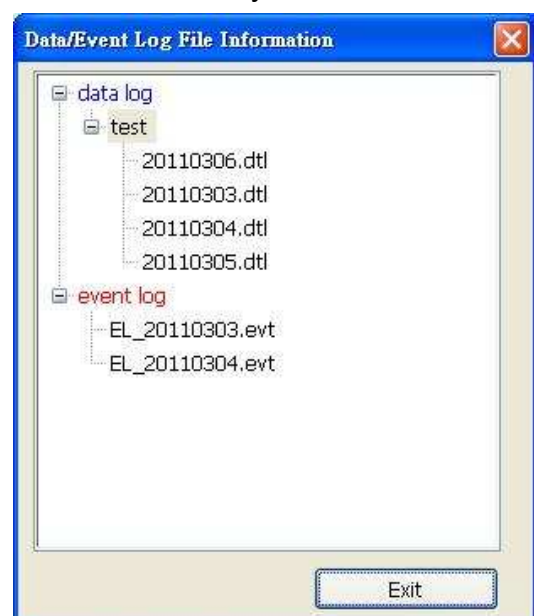

2.2 Utility

2.2.1 Build Download Data for Saving in CF/SD Card or USB Disk

1. Insert CF/SD/USB to PC.
2. Assign data storing path.
3. Assign files to download.
4. Build data.

The source files will be saved in the inserted device for users to download to HMI. This function is to build the required data.



2.2.2 Steps to Download Project to HMI via USB or CF/SD Card

Take downloading data in the folder named "123" (K:\123) in USB stick for example.

1. Insert USB (project included.) to HMI.
2. On **[Download / Upload]** dialog box select **[Download]**.
3. Input Download Password.
4. On **[Download Settings]** dialog box, check **[Download project files]** and **[Download history files]**.
5. Press **[OK]**.
6. On **[Pick a Directory]** dialog box, select directory: *usbdisk/device-0/123*.
7. Press **[OK]**.

Project will be automatically updated.



Even if users only download historical files, it is still necessary to reboot HMI manually to update files.

2.3 Transfer

2.3.1 Download

Download source files to HMI through Ethernet or USB cable.

Firmware Check to update HMI kernel programs. Must do when first time download data to HMI.

Click to assign desired downloading path.

Install X-series media-player drivers

Necessary when first time download data to X series HMI using EasyBuilder Pro.

Startup screen (i series only) Download assigned BMP to HMI. On HMI, it will be shown after rebooting then load in project. Users may use company logos.

Reboot HMI after download Automatically reboot after download.

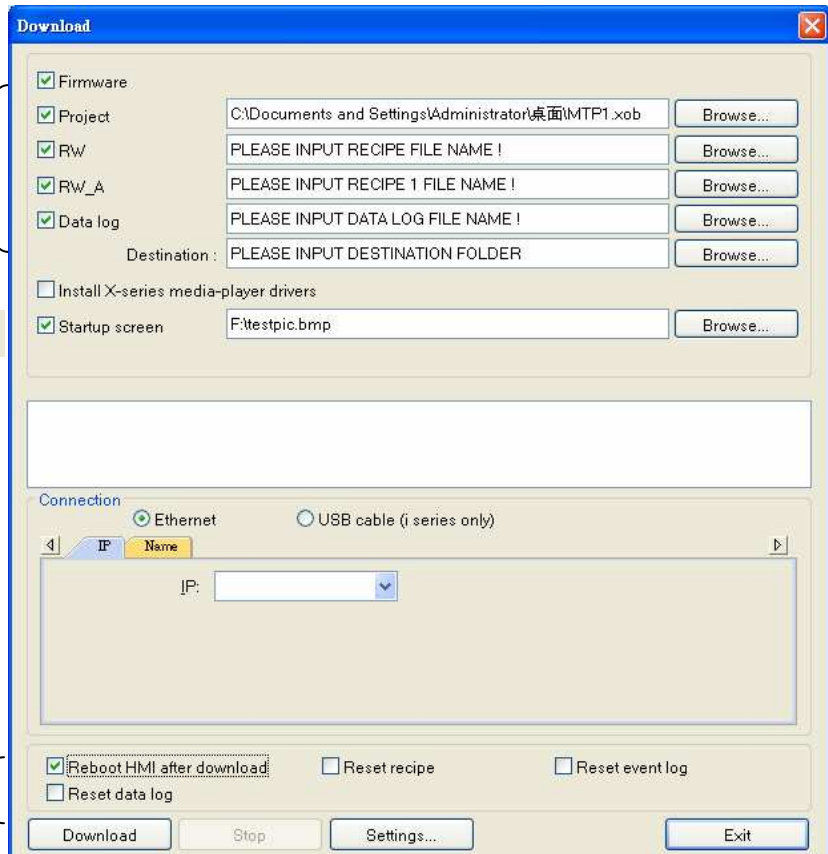

The screenshot shows the 'Download' dialog box with the following details:

- Checkboxes:** Firmware, Project, RW, RW_A, Data log, Install X-series media-player drivers, Startup screen.
- Text Fields:**
 - Project: C:\Documents and Settings\Administrator\桌面\MTP1.xob
 - RW: PLEASE INPUT RECIPE FILE NAME !
 - RW_A: PLEASE INPUT RECIPE 1 FILE NAME !
 - Data log: PLEASE INPUT DATA LOG FILE NAME !
 - Destination: PLEASE INPUT DESTINATION FOLDER
 - Startup screen: F:\testpic.bmp
- Connection:** Ethernet (selected), USB cable (i series only).
- Table:**

IP	Name
IP:	
- Bottom Checkboxes:** Reboot HMI after download, Reset recipe, Reset event log, Reset data log.
- Buttons:** Download, Stop, Settings..., Exit.

[Reset recipe] / [Reset event log] / [Reset data log]

Erase specified files on HMI before download.

2.3.2 Upload

Upload files from HMI to PC via Ethernet or USB cable.

Users have to assign the desired path for file storage before uploading.

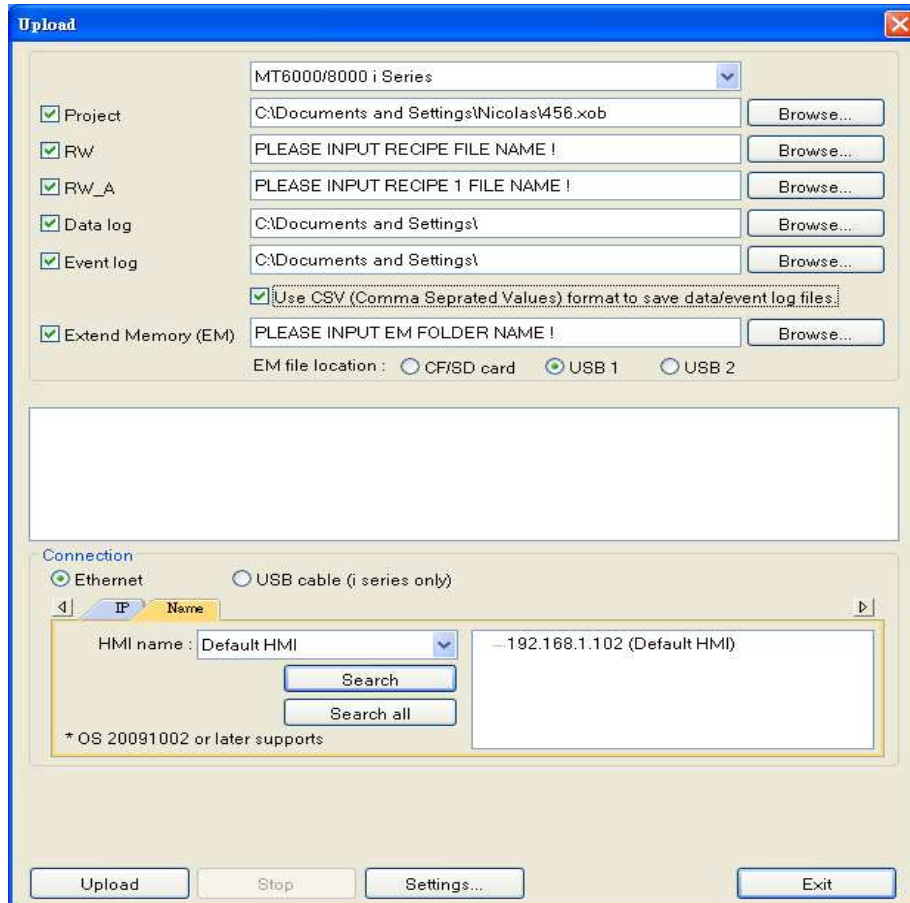

Click

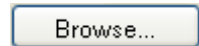

To assign desired uploading path.



The file will be uploaded to PC in *.XOB file format. For editing this file using EasyBuilder Pro, please decompile it into *. MTP file first.

2.4 Simulation

2.4.1 Off-line Simulation/On-line Simulation

Off-line simulation-Simulate project operation on PC.

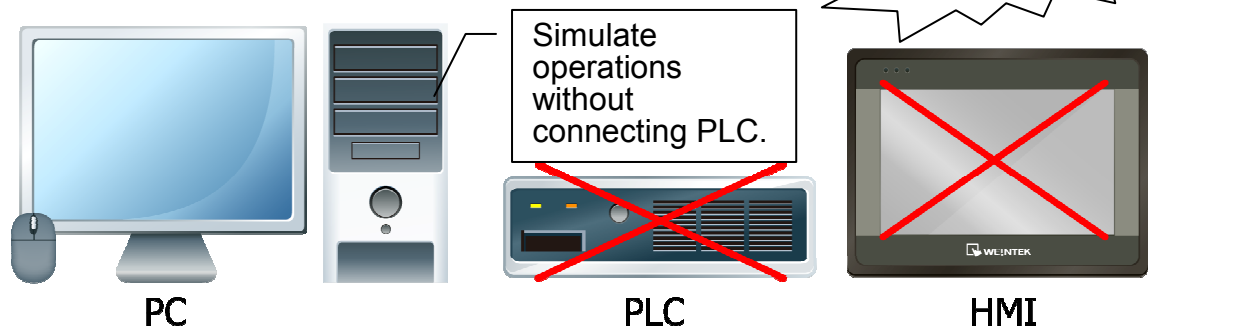

On-line simulation-Simulate project operation on PC.

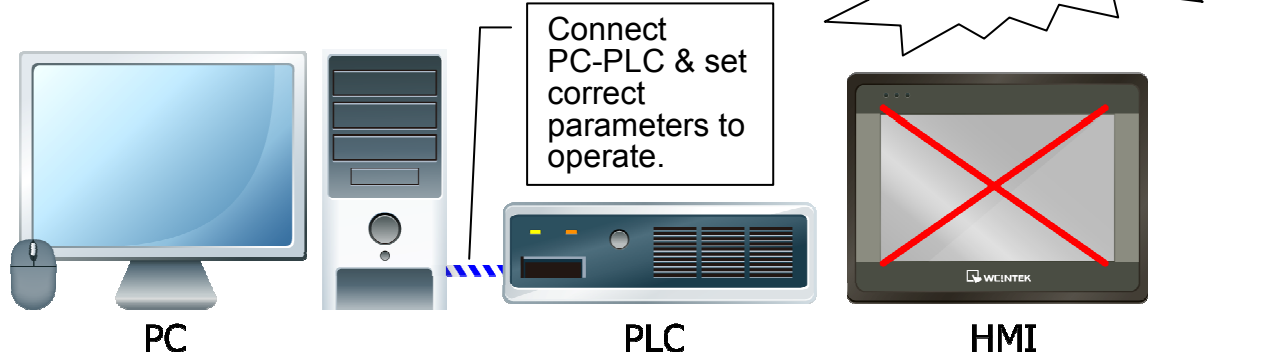

When On-line simulating on PC, if the control target is a local PLC (i.e. the PLC directly connected to PC), there is **10 minutes simulation limit**.

Before executing On-line/Off-line Simulation features, please select the source *.XOB file.

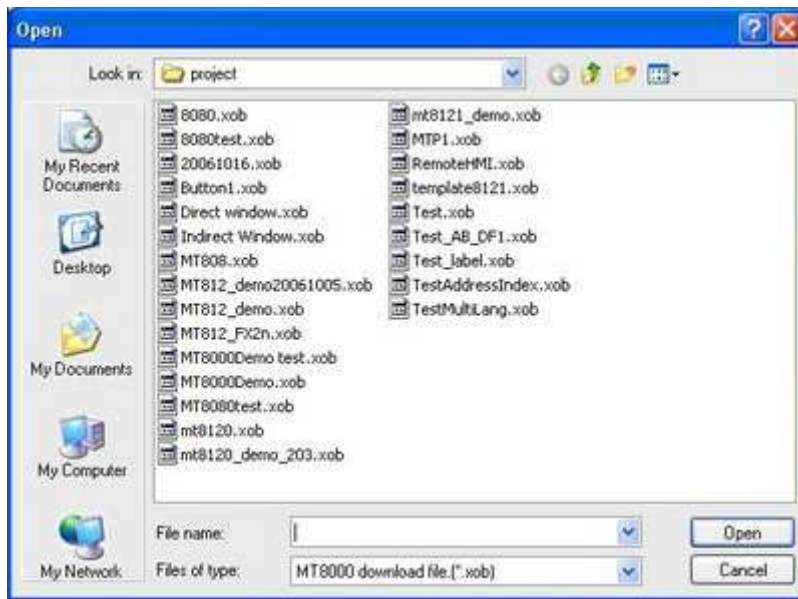

When executing on-line/off-line simulation, right click to use two functions:

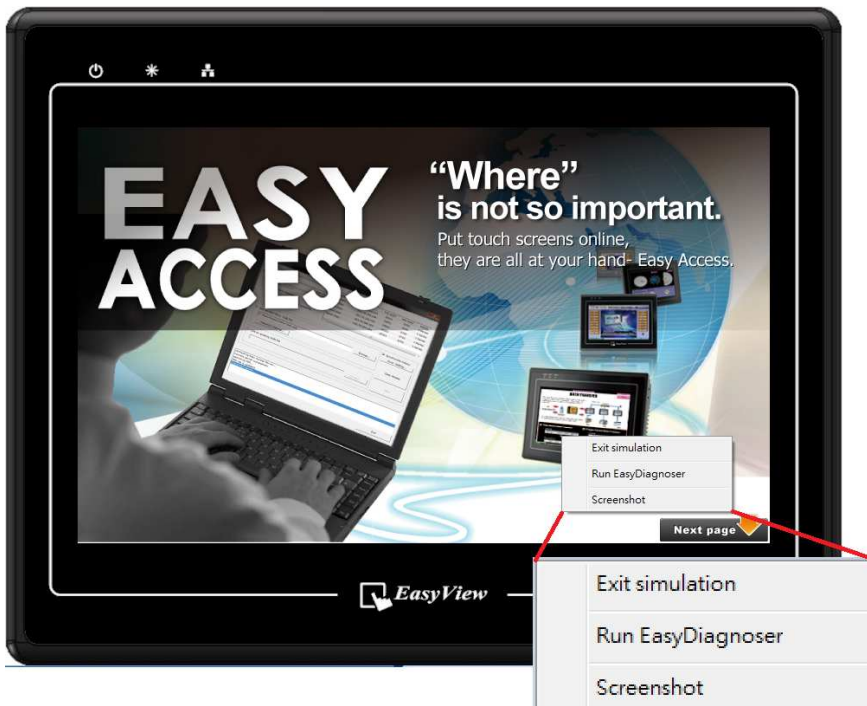

[Run EasyDiagnoser]

To monitor current communication status.

[Screenshot]

Capture and save current screen image as picture file in the screenshot folder under installation directory.

2.5 Pass-Through

This function allows the PC application to connect PLC via HMI. In this case, the HMI acts as a converter.

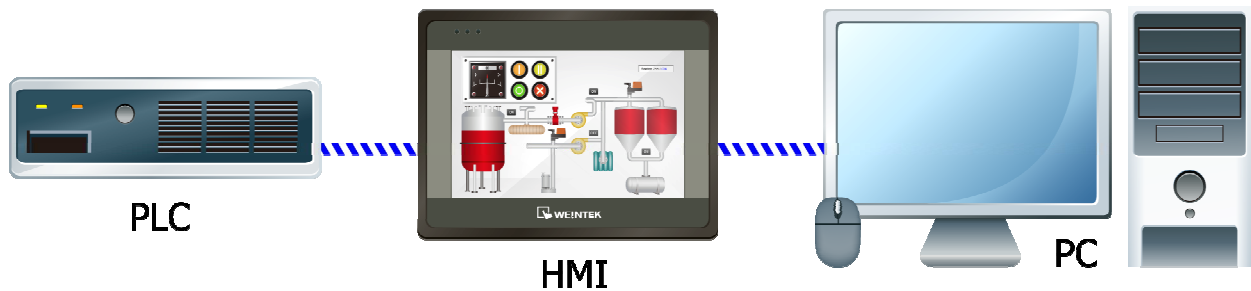

Pass-through provides two modes: **[Ethernet]** and **[COM port]**.

When using **[Ethernet]**, please install the virtual serial port driver first.



For detail, please refer to “Chapter 29 Pass Through Function”.

Chapter 3 Create an EasyBuilder Pro Project

Click on the icons to see illustration.

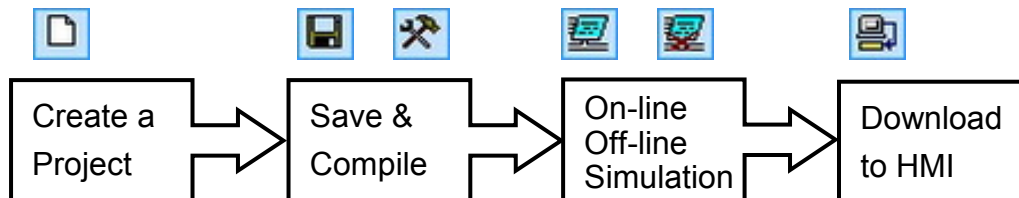

In this Chapter, we will take Mitsubishi PLC as an example.

3.1 Create a New Project

1. Click on icon New.
2. Select **[Model]**.
3. Tick **[Use template]**.
4. Click **[OK]**.

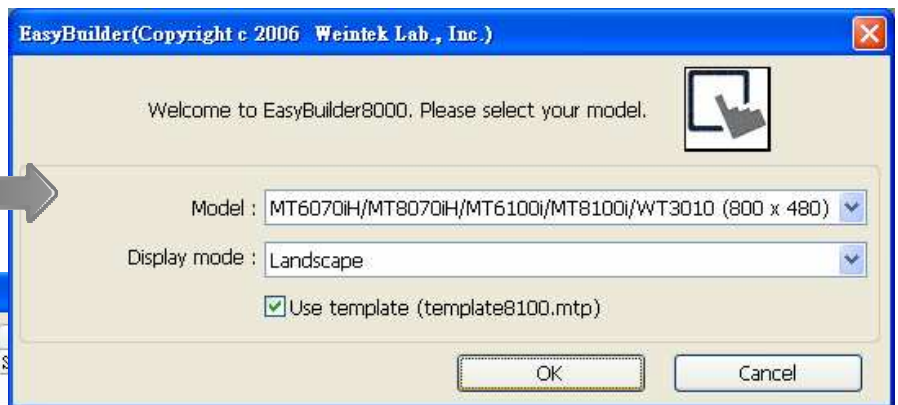

5. Click **[New]**.
6. Set correct parameters.
7. Click **[OK]**.

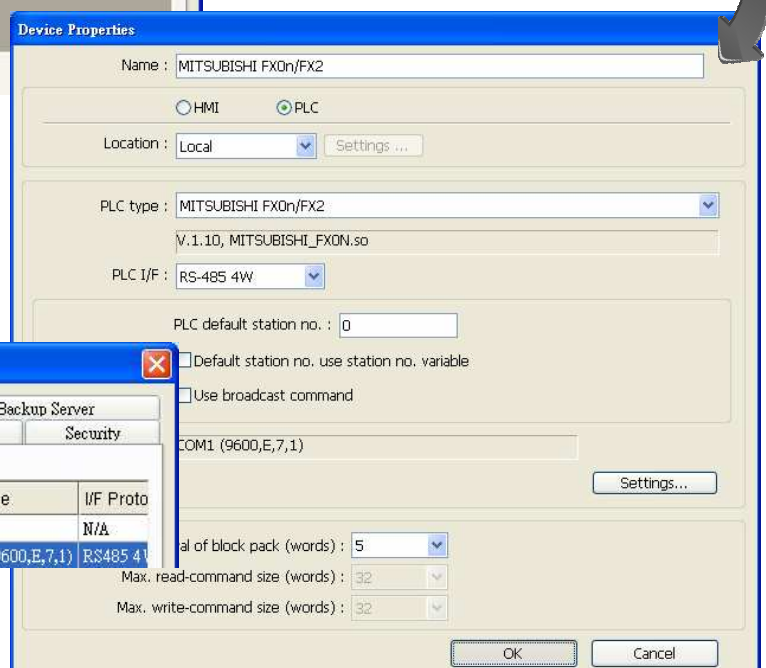

8. Device "MISUBISHI FX0n/FX2" is added to the **[Device List]**.



Now let's add a new object.

1. Click on the object icon  Toggle Switch Object.
2. Set correct parameters.

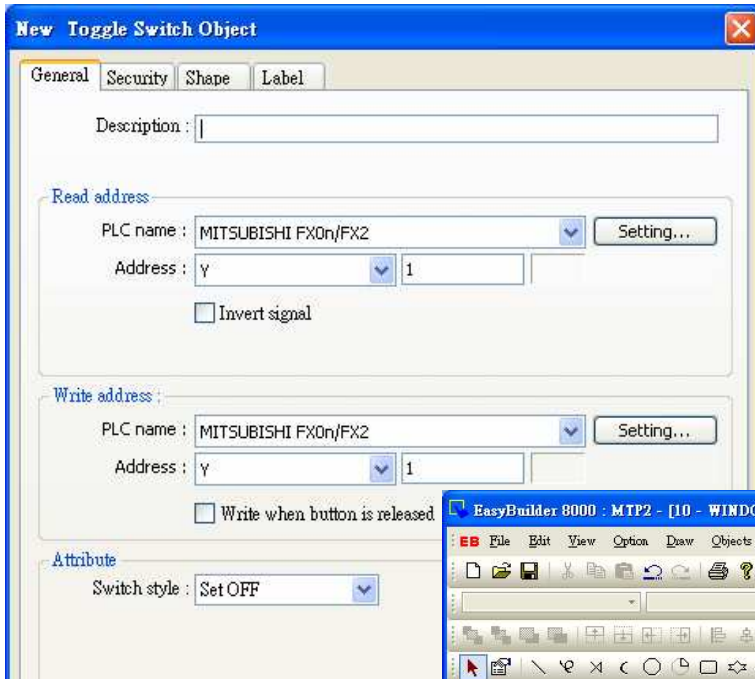

3. Place the object wherever you like on window.
4. A project with one object is now created.

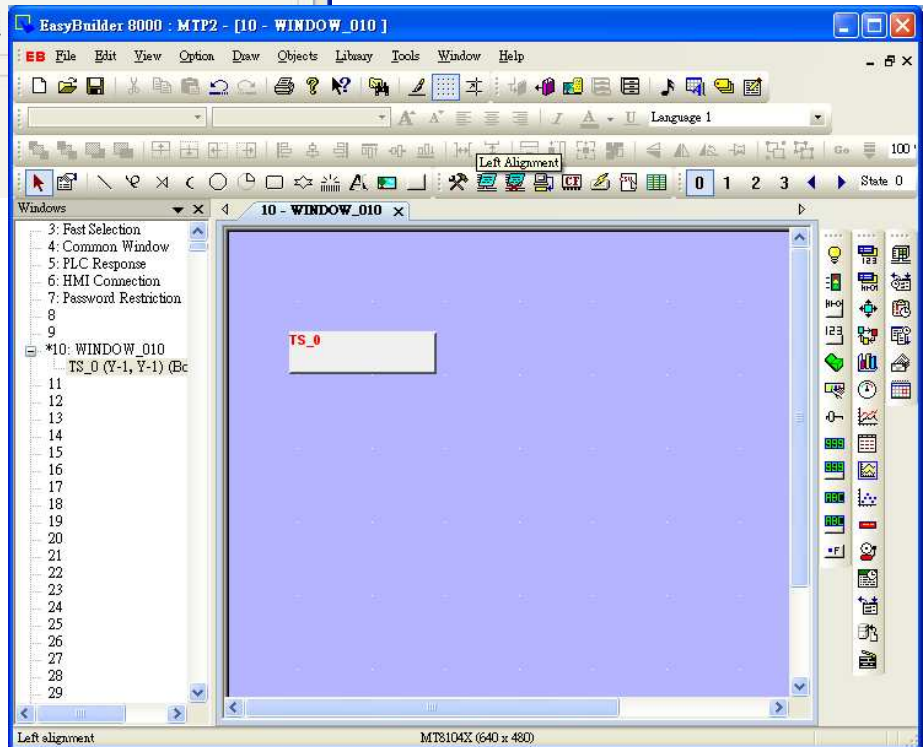

3.2 Save and Compile the Project

On EasyBuilder Pro Tool Bar:

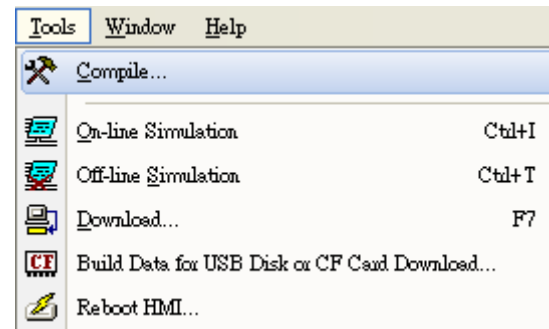
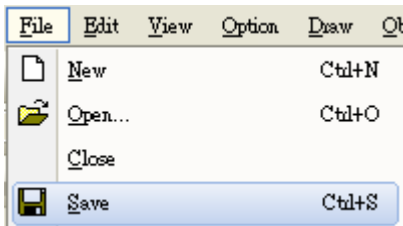

1. Click to **[Save]** *.MTP file.

2. Click to **[Compile]** to *.XOB file for downloading to HMI, this also checks if the project can run correctly.

Users are allowed to select the languages needed for the project by clicking **[Language 1 to 8]**.

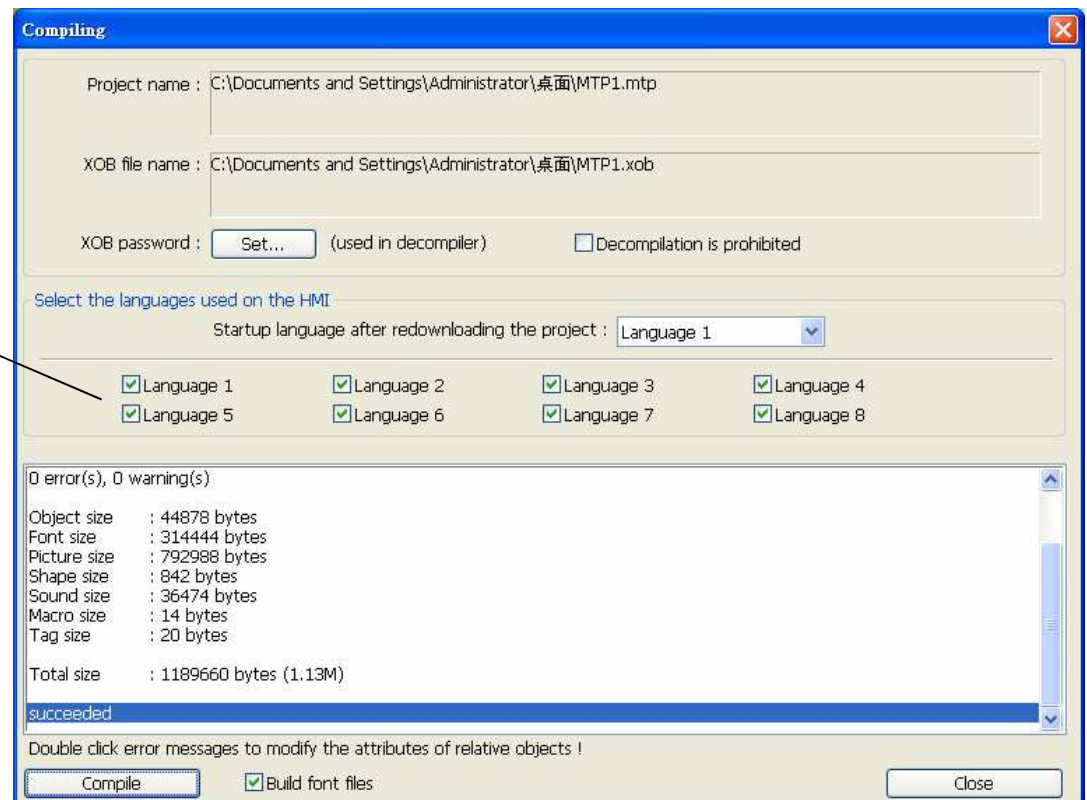

A successfully compiled file will get this dialog box.

3.3 Off-line and On-line Simulation

Off-line simulation - Simulate project operation on PC

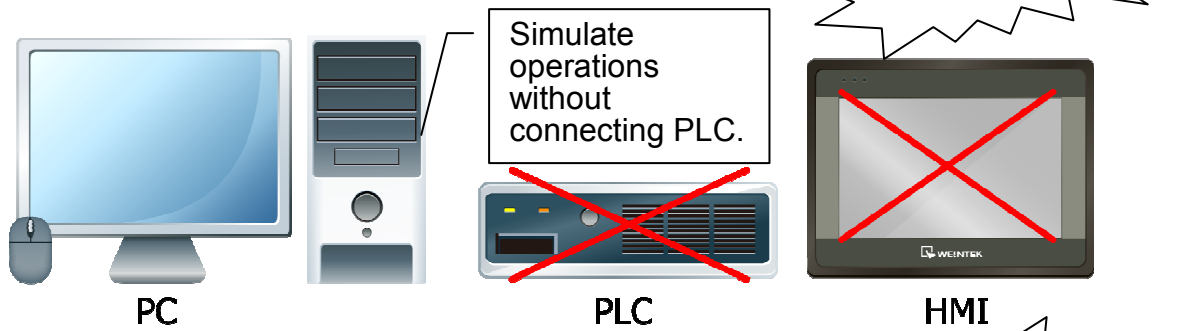

On-line simulation - Simulate project operation on PC

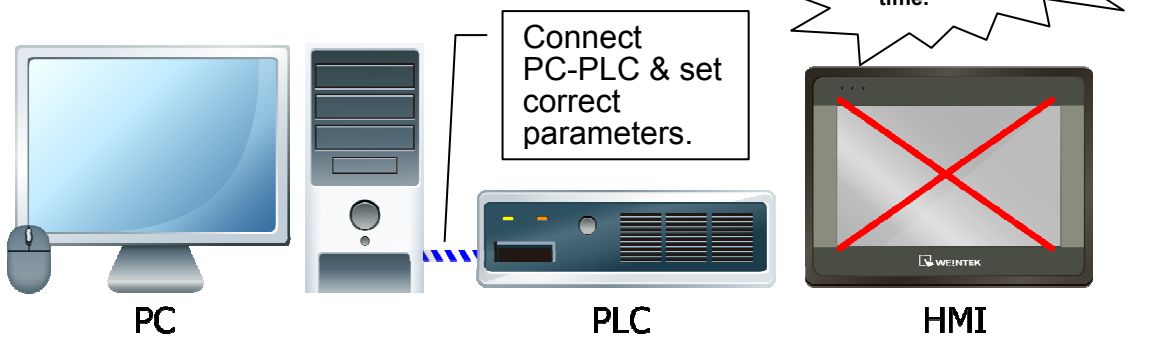

When On-line simulating on PC, if the control target is a local PLC (i.e. the PLC directly connected to PC), there is **10 minutes simulation limit**.

Off-line



On-line



Click after correctly connecting the device.

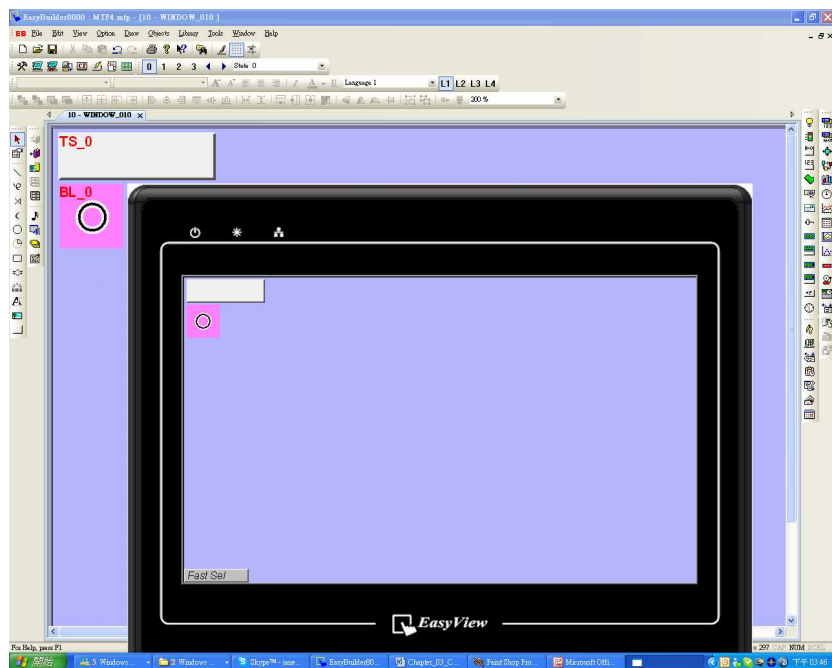

3.4 Download the Project to HMI

■ Way 1 [Ethernet] / HMI IP

Before **[Download]**, be sure to check if all the settings are correct.

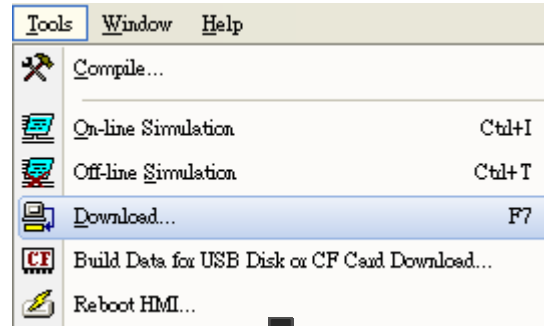

Input **[Password]** & Specify **[HMI IP]**

Firmware

Update HMI kernel programs. Must do this when first time download files to HMI.

Font files

Download the font used in project.

The selected files will be erased before downloading.

Reboot HMI after download

HMI will reboot after downloading.

Automatically using current settings to download after compiling

If this is checked, system will download project to HMI according to last settings. Please see illustration below.

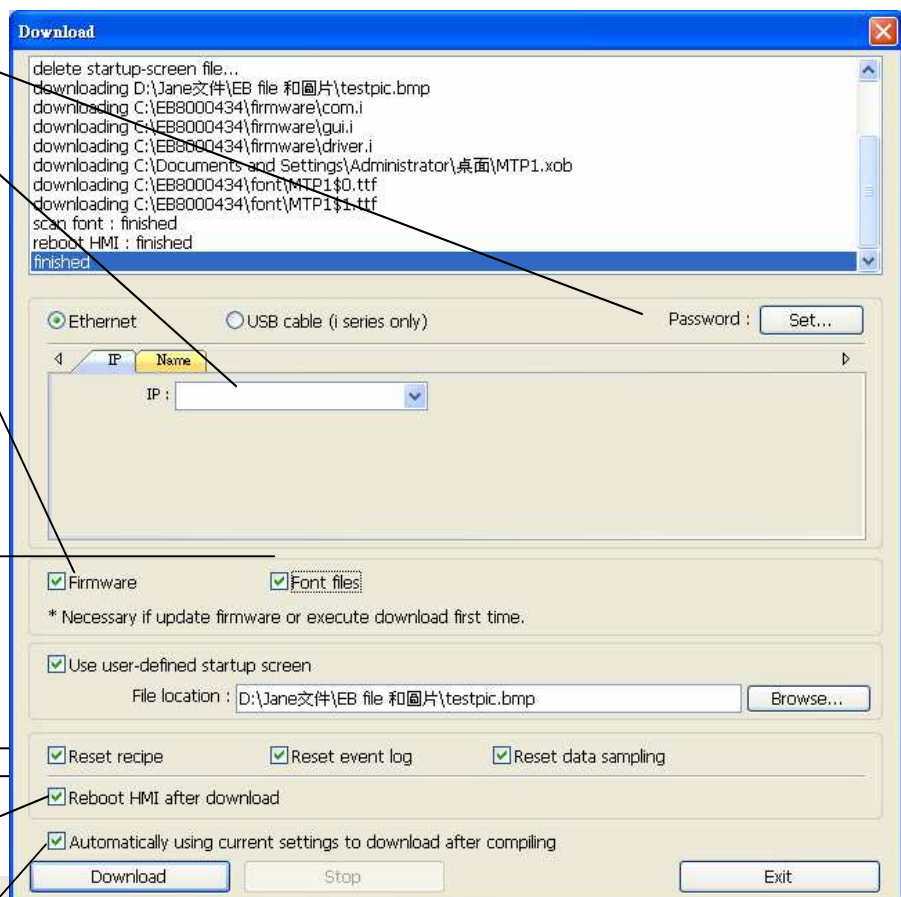

Automatically using current settings to download after compiling

The way to enable this function:

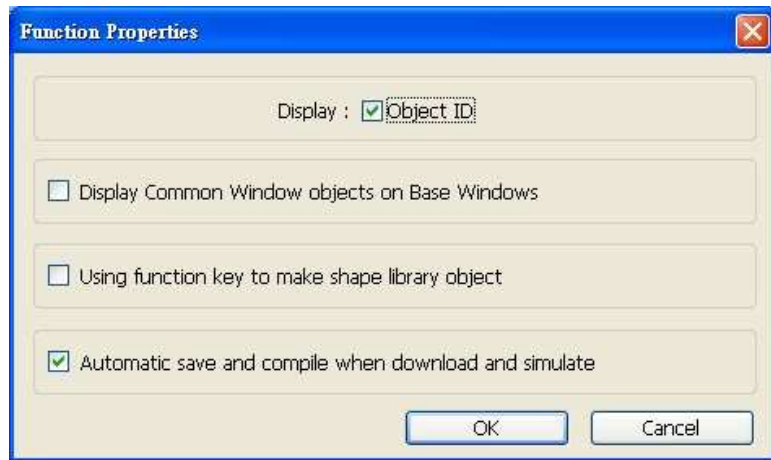
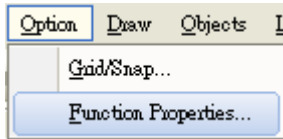

1. Click **[Function Properties]**.
2. Tick **[Automatic save and compile when download and simulate]**.



3. **[Save]** project.
4. Click **[Download]**.
5. On dialog box, tick **[Automatically using current settings to download after compiling]**.
6. Click **[Download]**.
7. After finish setting, next time when click **[Download]**, EasyBuilder Pro will automatically compile and download project to the latest target HMI.

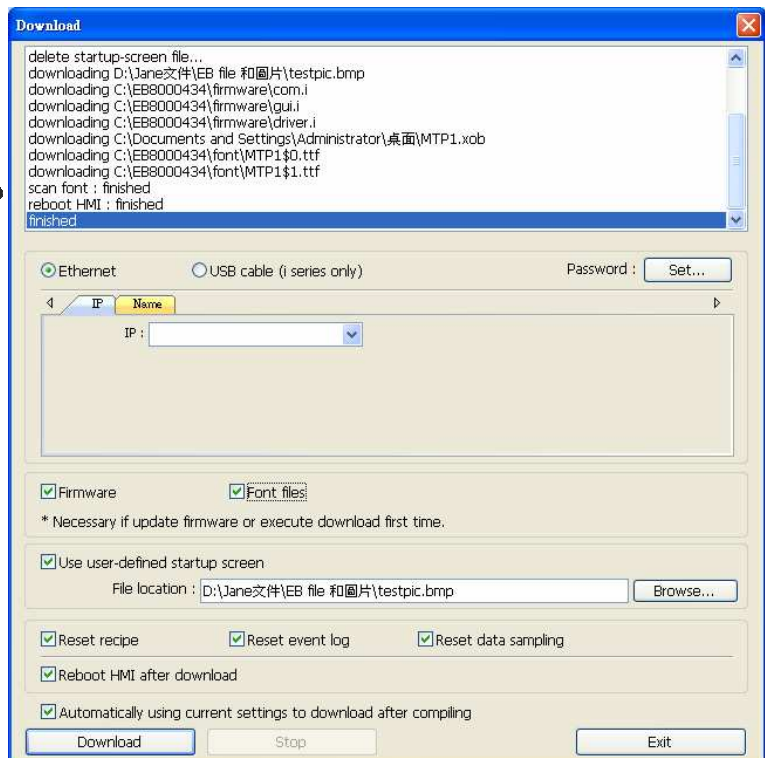

Way 2 [Ethernet] / HMI Name

1. On HMI set HMI name first.

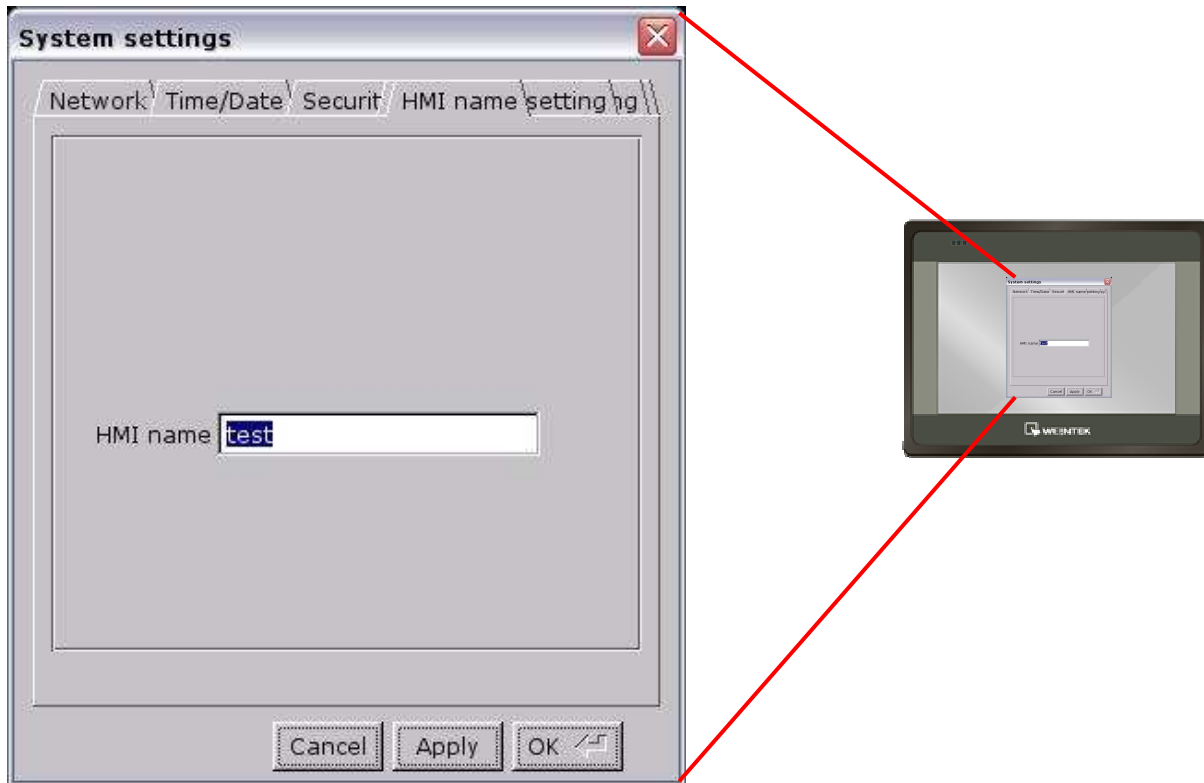

2. On PC, select the set HMI name and start downloading.

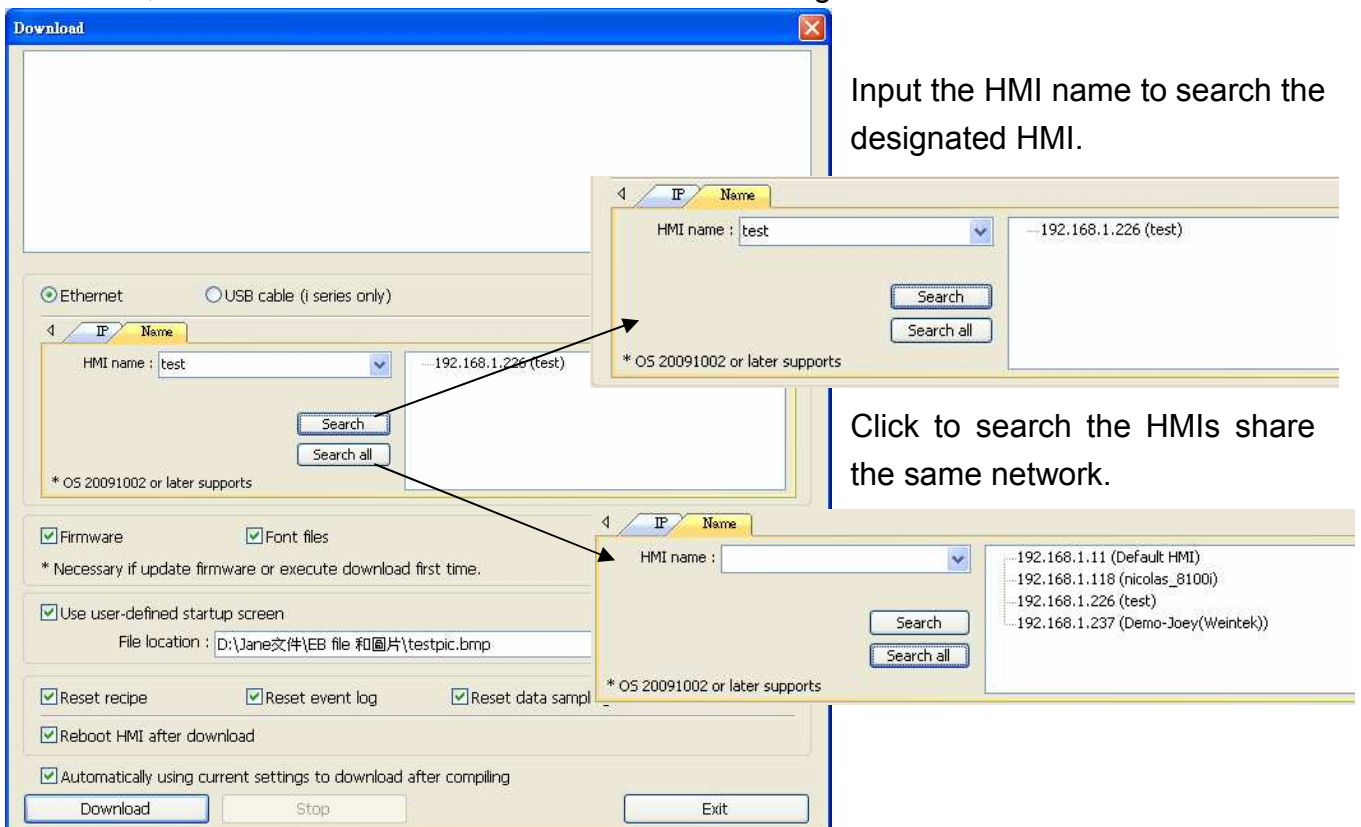

■ Way 3 [USB Cable]

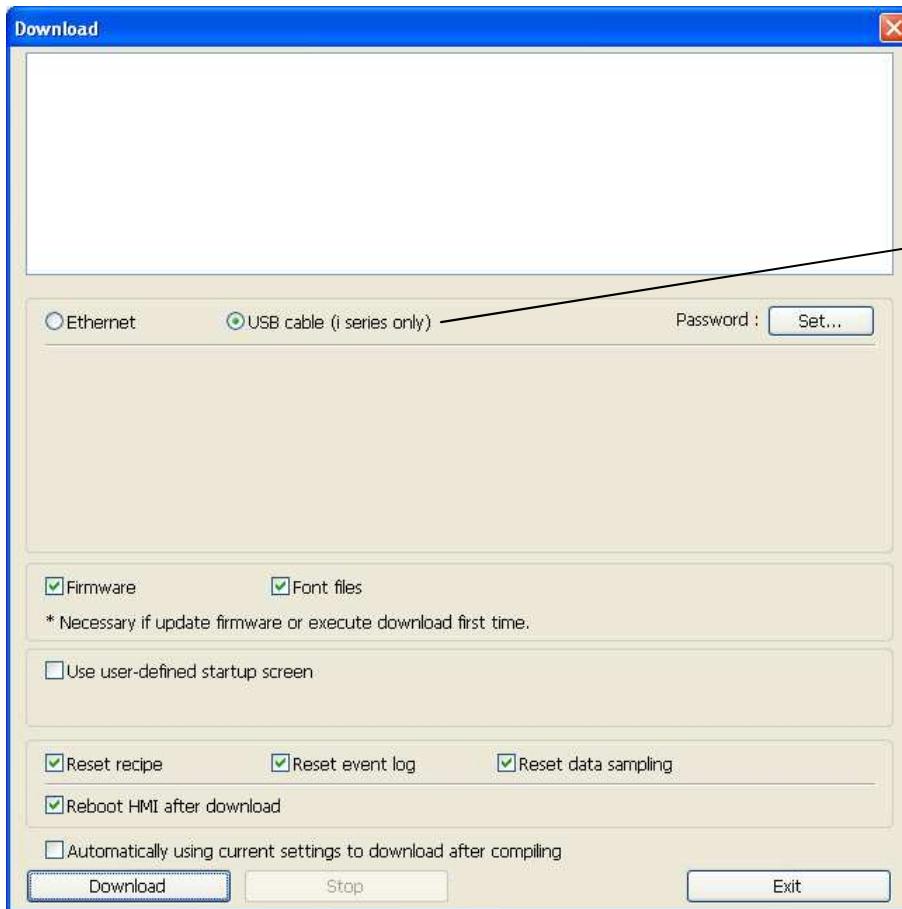

Select USB cable to download project to HMI. The way of setting is same as Way 1 mentioned above. USB cable only works for i Series HMI.



■ Before downloading via USB cable, please make sure the USB driver is correctly installed. Go to [Computer Management] / [Device Manager] to check if USB driver is installed, if not, please refer to [installation steps](#) to manually install.

Way 4 [USB Disk / SD Card]

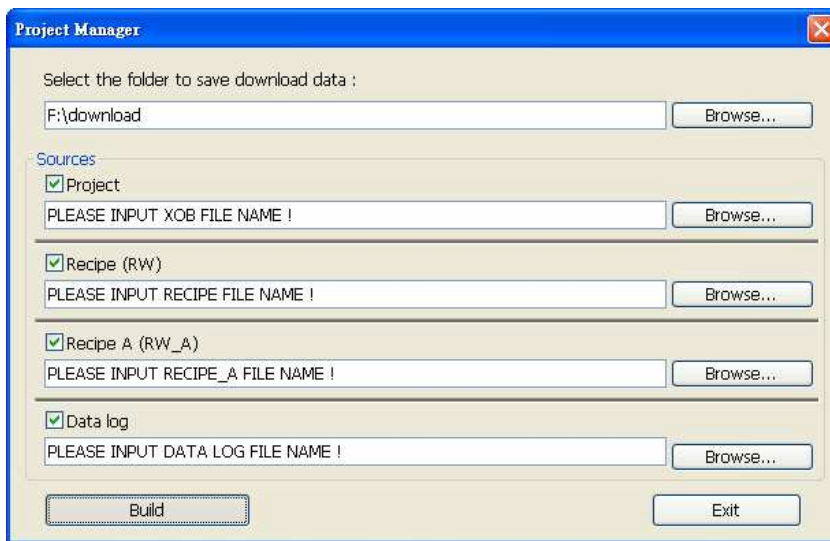

1. In Project Manager click **[Build Download Data for CF / SD / USB Disk]** to build the data to be downloaded first. Generally divided into 2 directories, if set as the way shown:



The download data storing structure:

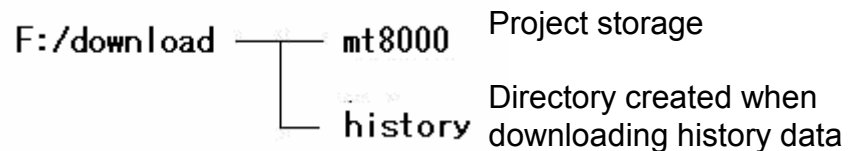

2. Insert external devices to HMI.
3. Select **[Download]** and input correct password.
4. Password confirmed, show directories in external device.(pccard: SD/CF Card ; usbdisk: USB Disk)
5. Select a directory for storing project then click

[OK] to start downloading.

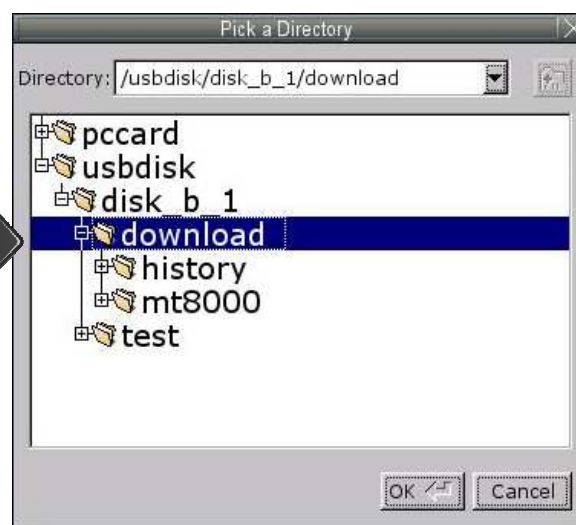
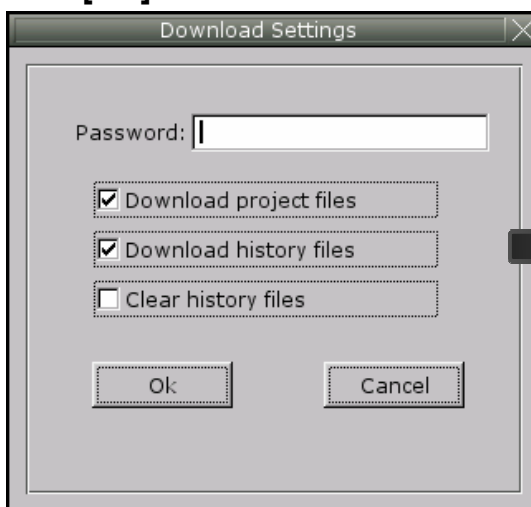







Please select the top layer directory of the target file when downloading. For the structure above, select **download**, not **mt8000** or **history**.

Chapter 4 Hardware Settings

4.1 I/O Ports of HMI

The I/O ports are different from one HMI type to another.

<p>SD CARD</p>  <p>Download/ Upload project via SD Card, including Recipe transfer, Event Log, Data Log...etc and to backup or record History data.</p>	
<p>COM PORT</p>  <p>Connects PLC or other peripheral devices. RS-232 / RS-485 2W/4W RS-422 = RS-485 4W</p>	
<p>ETHERNET</p>  <p>Connects Ethernet devices, such as PLC, laptop, for exchanging data via Network.</p>	
<p>USB STORAGE</p>  <p>Supports USB devices, such as mouse, keyboard, USB disk, printer</p>	
<p>MINI USB</p>  <p>Download/ Upload project including Recipe transfer, Event Log, Data Log...etc.</p>	

In addition, Weintek provides [MT8-COM1 Multi-Connector cable] and [MT8-COM3 Multi-Connector cable] to expand one COM port to multiple independent COM ports so that the convenience and efficiency of operation can be improved.

4.2 HMI System Settings

For the first time operating HMI, users have to complete the HMI system settings. After this, users can develop their own operation interface through EasyBuilder Pro editing software.

4.2.1 System Reset



Each HMI is equipped with a set of reset button and DIP switch. When using DIP switch to change modes, the corresponding functions will be triggered.

If system password is lost or forgotten, please set DIP Switch 1 to “ON” and the rest remain “OFF”, then reboot HMI.

HMI will switch to touch screen

calibration mode.



1. A “+” sign appears on the screen, touch the center of the sign, after all 5 signs are touched, “+” disappears and the touch screen parameter will be stored in HMI system.
2. After calibration, confirm to restore the system password to the default, select **[YES]**.
3. Confirm to restore to default password again by typing **[yes]** and clicking **[OK]**. The project files and history records stored in HMI will all be removed. (The default password is 111111. However, other passwords, including download/upload passwords have to be reset.)

SW1	SW2	SW3	SW4	Mode
ON	OFF	OFF	OFF	Touch screen calibration mode (X Series excluded)
OFF	ON	OFF	OFF	Hide system toolbar (T Series excluded)
OFF	OFF	ON	OFF	Boot loader mode (X Series excluded)
OFF	OFF	OFF	ON	Enable front panel power switch (X Series only)

The above shows

OFF	OFF	OFF	OFF	Normal
-----	-----	-----	-----	--------

 the steps to

restore factory settings of T and i Series HMI. For X Series, users will need a connected USB keyboard, and press any key (or space key) right when the first image displayed as HMI power ON to enter the menu. Select "Factory Mode", the window mentioned will pop up when system displays project. In case users may miss the very first image shown, to press space key continuously since HMI power ON will ensure entering the system setting window.

Dip Switch

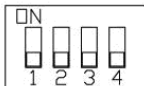

4.2.2 System Toolbar

After rebooting HMI, users can set the system with System Toolbar at the bottom of the screen. Normally, this bar is hidden automatically. Only by touching the target at the bottom-right corner of the screen will the System Toolbar pops up.



How to hide HMI System Setting Toolbar

EasyBuilder Pro supports the function of using system tag [LB-9020] to enable/disable system setting bar, or set the [DIP Switch 2] to ON/OFF for activating this function. When [LB-9020] is set ON, the bar is displayed, and set OFF to hide the system setting bar. When [DIP Switch 2] is set ON, the system setting bar is disabled, and when set OFF; the system setting bar is able to control. Users have to restart HMI to enable/disable this function.

Note: [LB-9020] is available for all HMI series. [DIP Switch 2] is available for i and X Series.



Text Keyboard



Number Keyboard



for



connect an USB mouse to select this mode.

Screen Calibration shortcut, X Series only, other series, turn SW1 to ON. When X Series touch screen drifting problem occurs, please

4.2.3 System Information

Network: Display network information & HMI IP. **Version:** Display HMI system version.

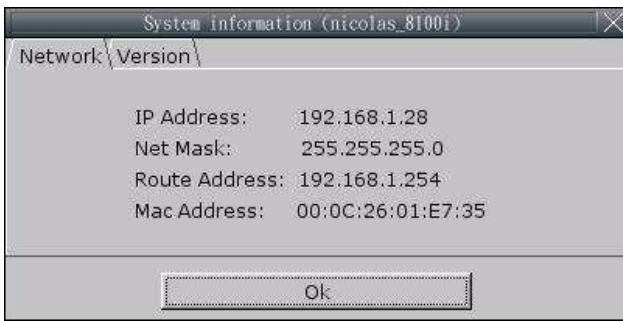

4.2.4 System Setting

Set or modify system parameters. Confirm password for security.

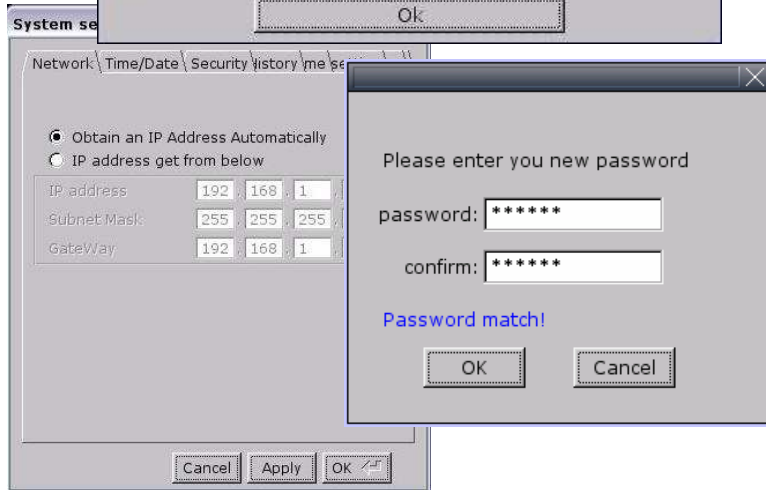

■ Network

Download project to HMI via Ethernet. Confirm IP address of target HMI. [Assign IP by local DHCP] or [Manually input IP information].

■ Time/Date Setting HMI local time/date.

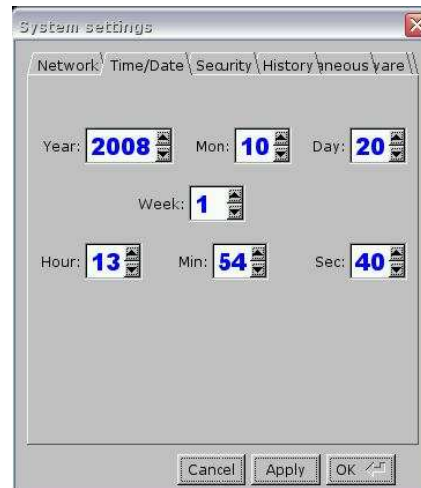

■ Security

Password protection, default 111111.

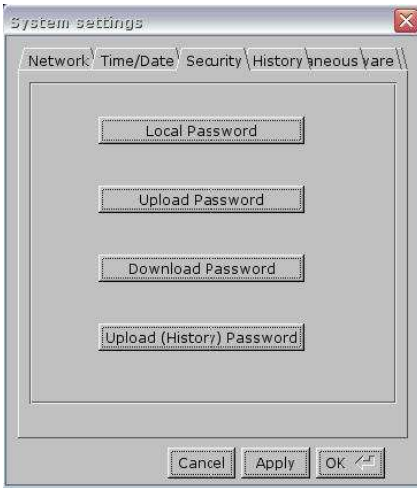

[Password for entering system]
 [Password for uploading project]
 [Password for downloading project]
 [Password for uploading history data]
 Password confirmation window:

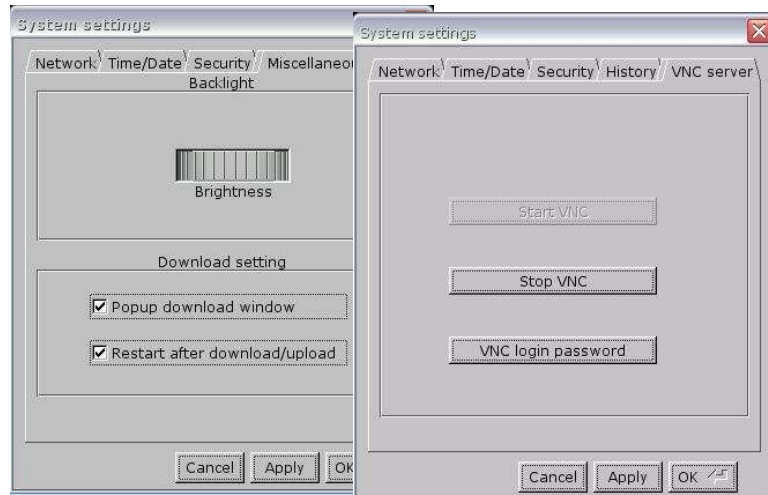

■ **Firmware setting**

Upgrade firmware / enable portrait mode.
 (i series only)

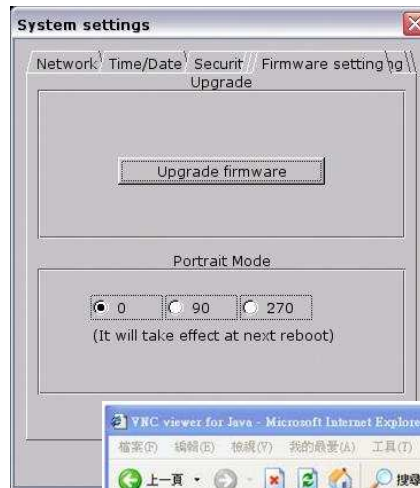

■ **History**

Clear history data on HMI.
 [Recipe] / [Eventlog] / [Datalog]

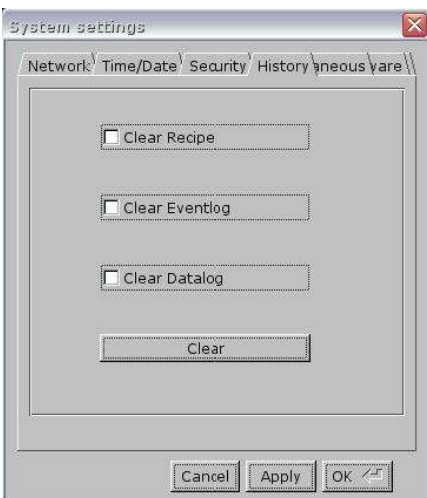

■ **Miscellaneous**

Rolling button for adjusting LCD brightness.

■ **HMI name**

Set HMI name to download/upload project.

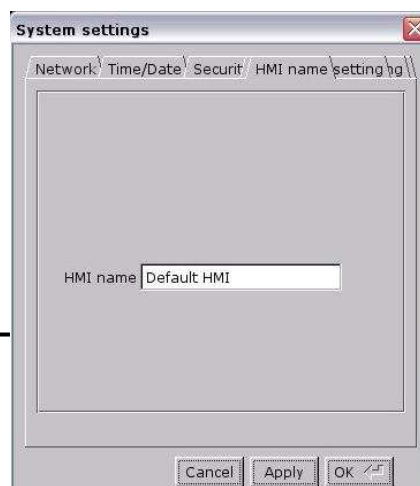

■ VNC server

Remote HMI monitoring and controlling.

1. Enable HMI VNC server, set password.
2. Install Java IE or VNC Viewer on PC.
- 3-1 Input remote HMI IP in IE, example:
<http://192.168.1.28>.
- 3-2 In VNC Viewer input remote HMI IP and password.

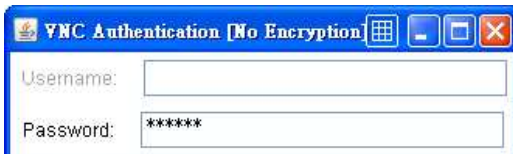



One HMI allows only one user to log in VNC server at one time. When leaving VNC server unused for one hour, HMI system will log out automatically.

Chapter 5 System Parameter Settings

Enter EB8000, select menu **[Edit] / [System Parameters...]** and the **[System Parameter Settings]** dialog appears:

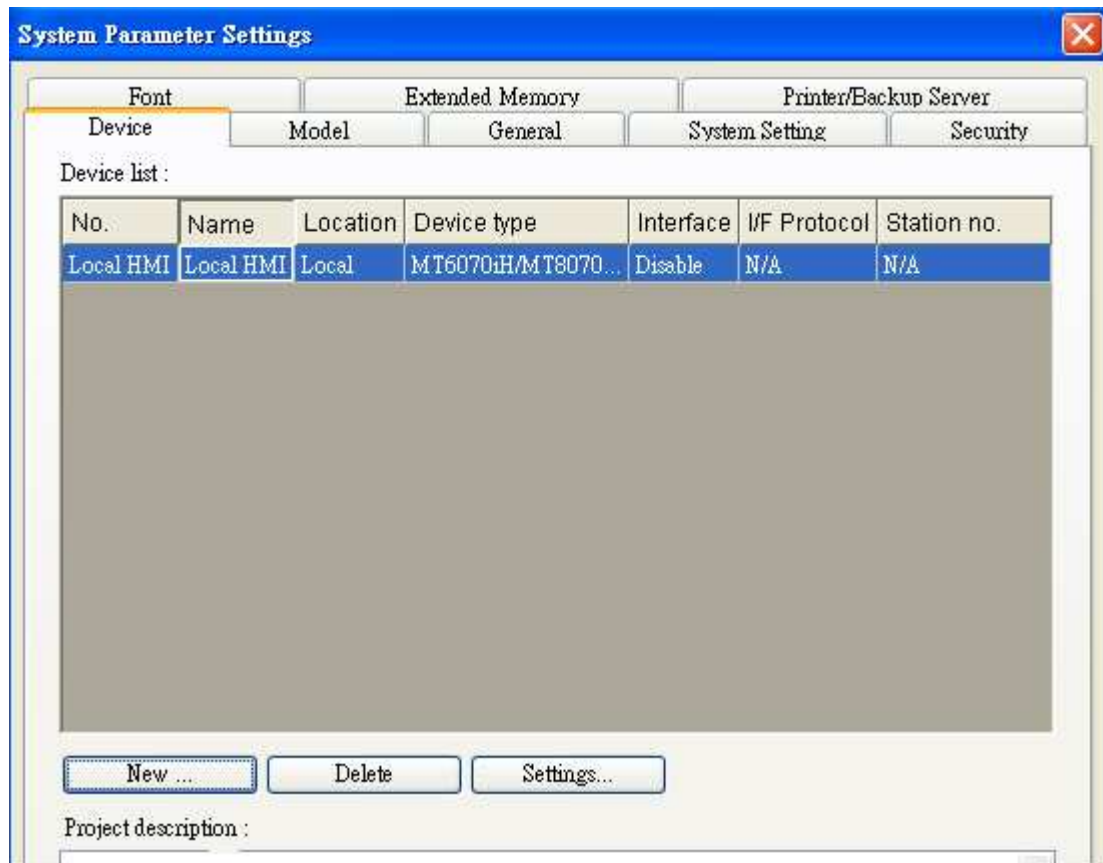

System Parameter Settings are divided into eight parts: **[Device]**, **[Model]**, **[General]**, **[System Setting]**, **[Security]**, **[Font]**, **[Extended Memory]**, and **[Printer/Backup Server]**. These will be introduced respectively in this chapter.

5.1 Device

Parameters in **[Device]** tab determine all of the attributes of each device controlled by the HMI they are connected with. The device can be a PLC, a remote HMI, or a PC.

After opening a new *.mtp file in EB8000, a default device: "Local HMI" is shown in the **[Device List]**. This "Local HMI" is used to identify current HMI, which means, every *.mtp file must at least contains one "Local HMI" in **[Device List]**.

Select **[Settings]** under the device list, A dialogue **[Device Properties]** will be shown as below. From this we know that the attribute of "Local HMI" is a "HMI" and the location is "Local".

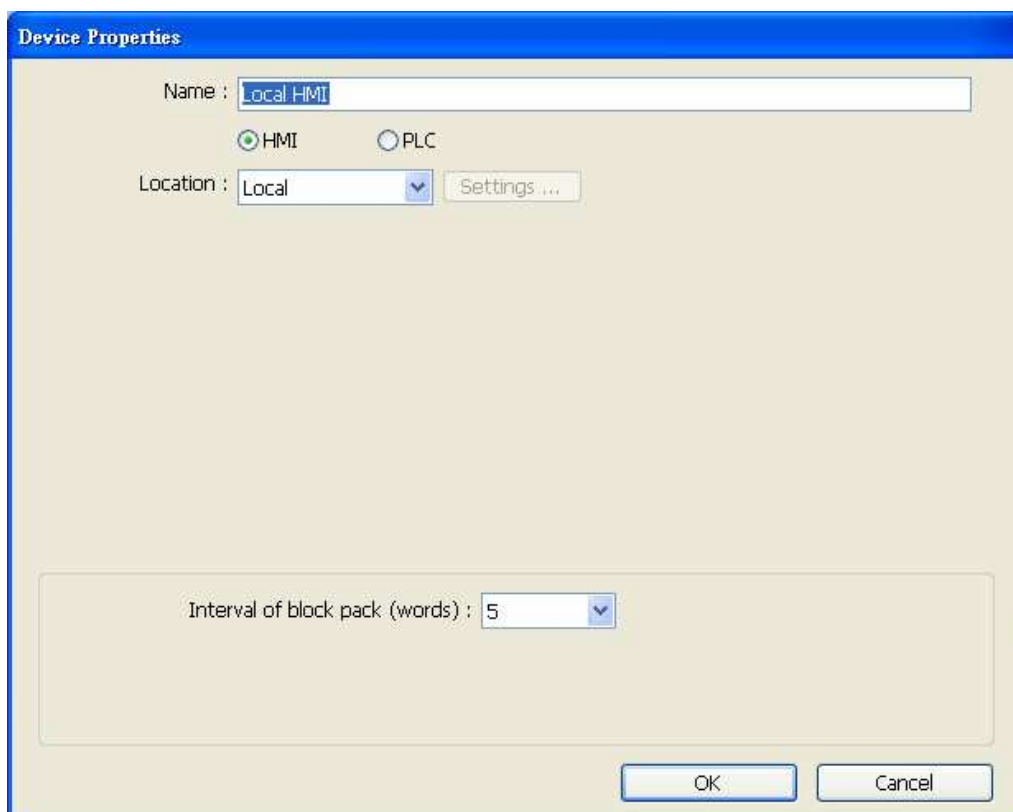

Steps to add a new device:

5.1.1 How to Control a Local PLC



The so-called “local PLC” means a PLC which is connected to the local HMI directly. To control a local PLC, users need to add this type of device first. Click **[New...]** under the Device list and the **[Device Properties]** dialog appears. Please correctly fill in all of the properties required.

Take a local PLC MITSUBISHI FX0n/FX2 as an example:

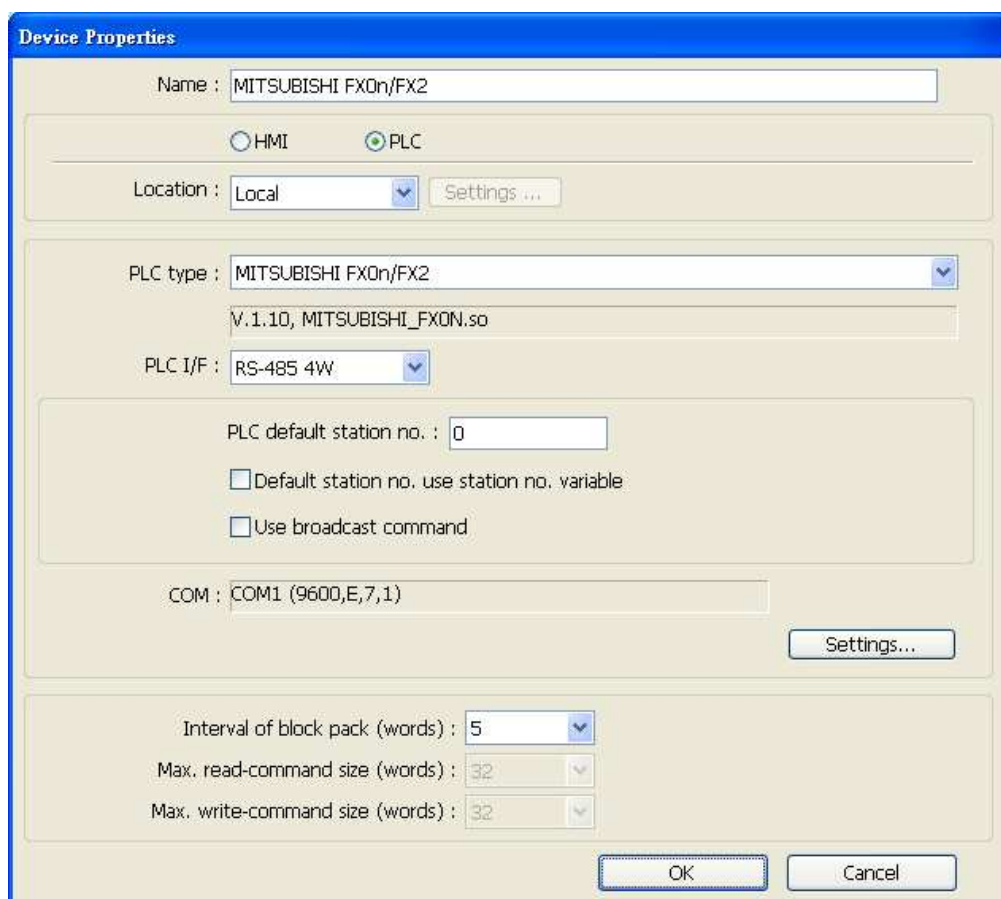

Setting	Description
Name	The name of the device set by user.
HMI or PLC	To confirm whether this connected device is a HMI or PLC. It's [PLC] in this example.
Location	[Local] or [Remote] . Showing whether this device is connected to Local HMI or being remote controlled. Select [Local] in this case.

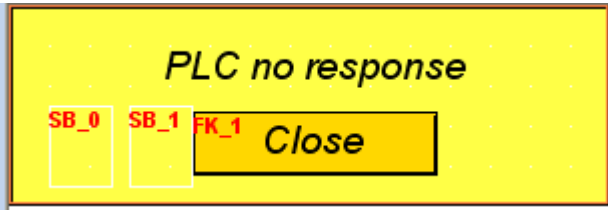
PLC type	Type of PLC. Select MITSUBISHI FX0n/FX2 in this case.
PLC I/F	<p>Five PLC interfaces are available: [RS-232], [RS-485 2W], [RS-485 4W], [Ethernet], and [USB].</p> <p>If the interface is [RS-232], [RS-485 2W], or [RS-485 4W], click [Settings...] and then [Com Port Settings] dialog appears. Users need to correctly set the COM port communication parameters.</p> <div data-bbox="571 539 1275 900" data-label="Image">  </div> <p>[Timeout]</p> <p>If the communication between PLC and HMI is disconnected over the set time limit in [Timeout] parameter, a pop out window No. 5 will be shown in HMI as an alert saying “PLC No Response”.</p> <div data-bbox="619 1211 1230 1420" data-label="Image">  </div> <p>[Turn around delay]</p> <p>While sending the next command to PLC, HMI will delay it obeying the set time interval in [Turn around delay] parameter. This may influence the efficiency of the communication between HMI and PLC. If no specific request to be made, “0” is to be set.</p> <p>If the PLC used is in SIEMENS S7-200 Series, this parameter needs to be set to “5” and [Parameter 1] “30”.</p> <p>If the interface is [Ethernet], click [Settings...] and then [IP Address Settings] dialogue appears. Users need to correctly set IP address and Port no. of the PLC.</p>

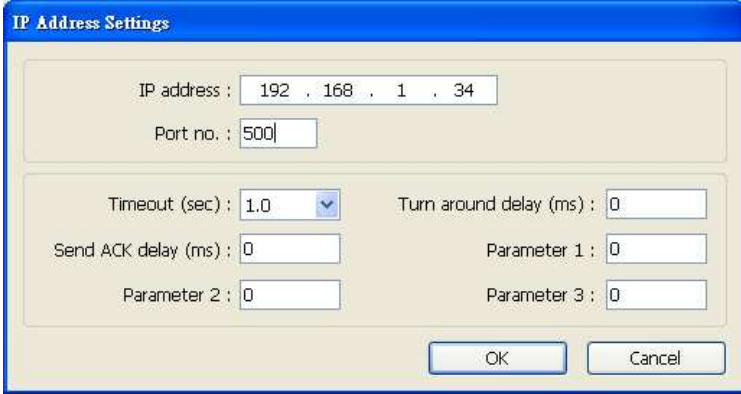
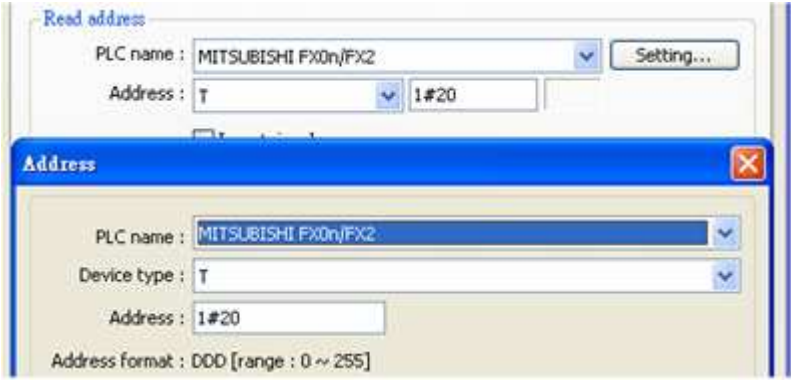
	 <p>The screenshot shows the 'IP Address Settings' dialog box. It contains the following fields: IP address (192 . 168 . 1 . 34), Port no. (500), Timeout (sec) (1.0), Turn around delay (ms) (0), Send ACK delay (ms) (0), Parameter 1 (0), Parameter 2 (0), and Parameter 3 (0). There are 'OK' and 'Cancel' buttons at the bottom right.</p> <p>If the interface is [USB], no further settings need to be done. Please check if all the settings in [Device Properties] are correct.</p>
<p>PLC default station no.</p>	<p>PLC should be set with a read address alone with a station no. for HMI to locate and communicate with it. If this address does not include a station no. EB8000 will use this [PLC default station no.] as the station no. of PLC.</p> <p>In addition, station no. can be set in the read address of PLC directly. Take address 1#20 as an example.</p>  <p>The screenshot shows two dialog boxes. The top one is 'Read address' with fields for PLC name (MITSUBISHI FX0n/FX2), Address (T), and a value of 1#20. The bottom one is 'Address' with fields for PLC name (MITSUBISHI FX0n/FX2), Device type (T), and Address (1#20). The address format is noted as DDD [range : 0 ~ 255].</p> <p>“1” means PLC station no, and has to be named from 0 to 255. “20” means PLC address, the “#” sign is used to separate station no. and address.</p>
<p>Default station no. use station no. variable</p>	<p>When setting PLC properties, station no. variables can be selected and used as [PLC default station no.]. LW10000~LW10015 can be used to set station no. variables.</p> <p>When using this function, if the station no. is not specified for PLC address, it will be decided by the station no. variable of default station no. In this example var3 is set for default station no. The following</p>

	<p>demonstrates how the PLC address station no. is set.</p> <p>a. The station number of PLC is “5”.</p> <p>PLC name : MODBUS RTU Address : 4x 5#111</p> <p>b. The PLC station no. is decided by var7 (LW-10007)</p> <p>PLC name : MODBUS RTU Address : 4x var7#111</p> <p>c. PLC address is set to “111”, since PLC station no. is not specified, and the default station no. is using var3, the PLC station no. is decided by var3 (LW-10003).</p> <p>PLC name : MODBUS RTU Address : 4x 111</p>
Use broadcast command	<p>This is for setting the station no. of broadcast command. Command for the users of this set station no. will be seen as broadcast command. For example, if the broadcast station number is set as 255, HMI with an address such as 255#200, will send this command to all the PLC connected to it, but will ignore the replies of PLC after receiving this command. (This only works on Modbus).</p> <p><input checked="" type="checkbox"/> Use broadcast command Broadcast station no. : 255</p>
Interval of block pack (words)	<p>If the interval between read addresses of different commands is less than this value, these commands can be combined to one. But combining function is disabled if this value is “0”.</p> <p>For example, the interval value is set as “5” and users would like to read out 1 word from LW3 and 2 words from LW6 respectively. (Means to read from LW6 to LW7). Since the interval of addresses between LW3 and LW6 is less than 5, these two commands can be combined to one. The contents of combination therefore become 5 consecutive words from LW3 (read from LW3~LW7).</p> <p>Note: Maximum command combination data size must be less than [Max. read-command size].</p>
Max. read-command size (words)	<p>The Max. data size to be read out from device at one time. Unit: word</p>

Max. write-command size (words)	The Max. data size to be written to device at one time. Unit: word.
--	---

After all settings are completed, a new device named “Local PLC 1” is added to the **[Device list]**.

Device list :

No.	Name	Location	Device type	Interface	I/F Protoc
Local HMI	Local HMI	Local	MT8121 T (800 x 600)	Disable	N/A
Local PLC 1	MITSUBISHI FX0...	Local	MITSUBISHI FX0n/...	COM1 (9600,E,7,1)	RS485 4 W

5.1.2 How to Control a Remote PLC



The so-called “remote PLC” means a PLC connected to a remote HMI. To control a remote PLC, users need to add this type of device. Click **[New...]** under **[Device list]** and the **[Device Properties]** dialog appears. Users need to set all the required properties correctly.

Here take a remote PLC, SIEMENS S7/200, as an example:

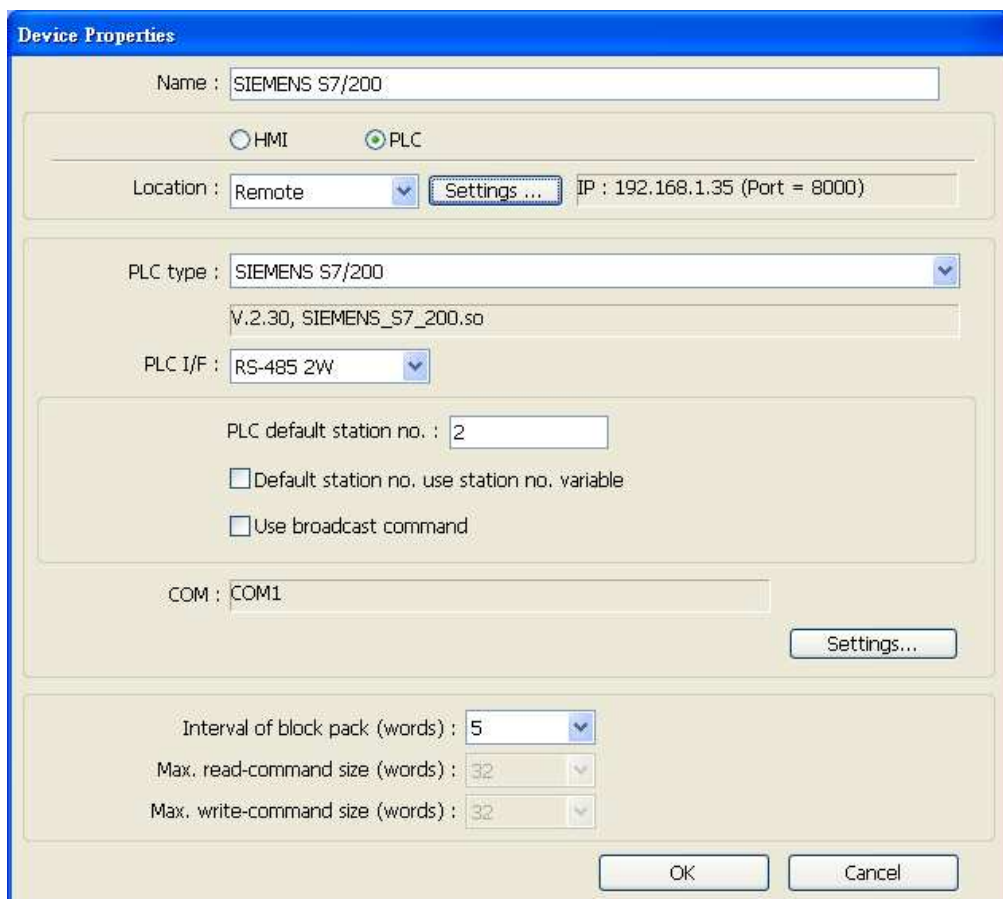

Setting	Description
HMI or PLC	This is to confirm whether this device is a HMI or PLC. It is [PLC] in this case.
Location	Users can select [Local] or [Remote] . Select [Remote] in this case

and set the IP address of the remote HMI which is connected to SIEMENS S7/200 PLC. Click **[Settings...]** of **[Location]** to set this IP address.

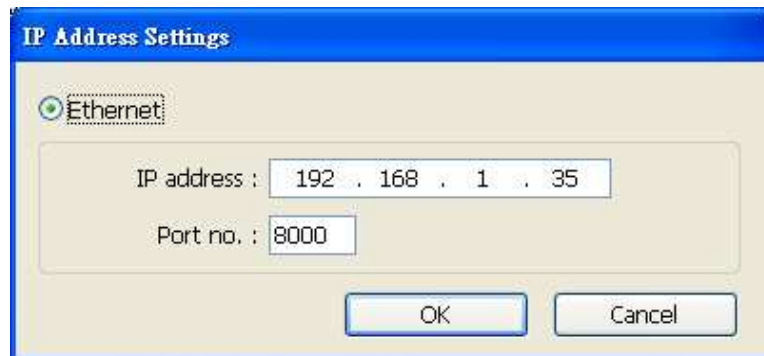

PLC Type	Type of PLC. Select SIEMENS S7/200 in this case.
PLC I/F	This setting defines which interface the remote PLC uses. If the remote PLC uses a COM port, interface used should be selected from [RS-232] , [RS-485 2W] , and [RS485 4W] .
PLC default station no.	This setting defines which default station no. is used by remote PLC.
COM	This setting defines which COM port the remote PLC uses to connect with remote HMI. The settings should be correct.

After all settings are completed, a new device named “Remote PLC” is added to the **[Device list]**.

Device list :

No.	Name	Location	Device type	Interface
Local ...	Local HMI	Local	MT8121T (800 x 600)	Disable
Local ...	MITSUBISHI FX0n/FX2	Local	MITSUBISHI FX0n/FX2	COM1 (9600,E,7,1)
Remo...	SIEMENS S7/200	Remote (IP:192.168.1....	SIEMENS S7/200	COM1 (9600,E,8,1)

5.1.3 How to Control a Remote HMI



The so-called “remote HMI” means through network, this HMI is controlled by a local HMI or a PC running on-line simulation. To control a remote HMI, users need to add this type of device. Click **[New...]** under **[Device list]** and the **[Device Properties]** dialog appears. Users need to set all the required properties correctly.



Setting	Description
HMI or PLC	This is to confirm whether this device is a HMI or PLC. It is [HMI] in this case.
Location	Users can select [Local] or [Remote] . Select [Remote] in this case and set the [IP address] and [Port no.] of the remote HMI. Click [Settings...] of [Location] to set these, the dialogue is shown below. The [Port no.] of remote HMI can be seen in [Model] in [System parameters] once the* .mtp file of remote HMI is opened. The port no. of remote HMI and local HMI must be the same.



After all settings are completed, a new device named “Remote HMI” is added to the **[Device list]**.

No.	Name	Location	Device type	Interface	I/F ...	St...
Local...	Local HMI	Local	MT8xxx	N/A	N/A	N/A
Local...	MITSUBISHI F...	Local	MITSUBISHI F...	COM1(96...	RS4...	0
Rem...	SIEMENS S7/200	Remote(IP:192.168.1.10, P...	SIEMENS S7/2...	COM1(96...	RS4...	2
Rem...	Remote HMI	Remote(IP:192.168.1.11, P...	MT8xxx	Ethernet	TC...	N/A

5.2 Model

Parameters in **[Model]** tab determine the HMI model, **[Timer]** and **[Printer]** settings.

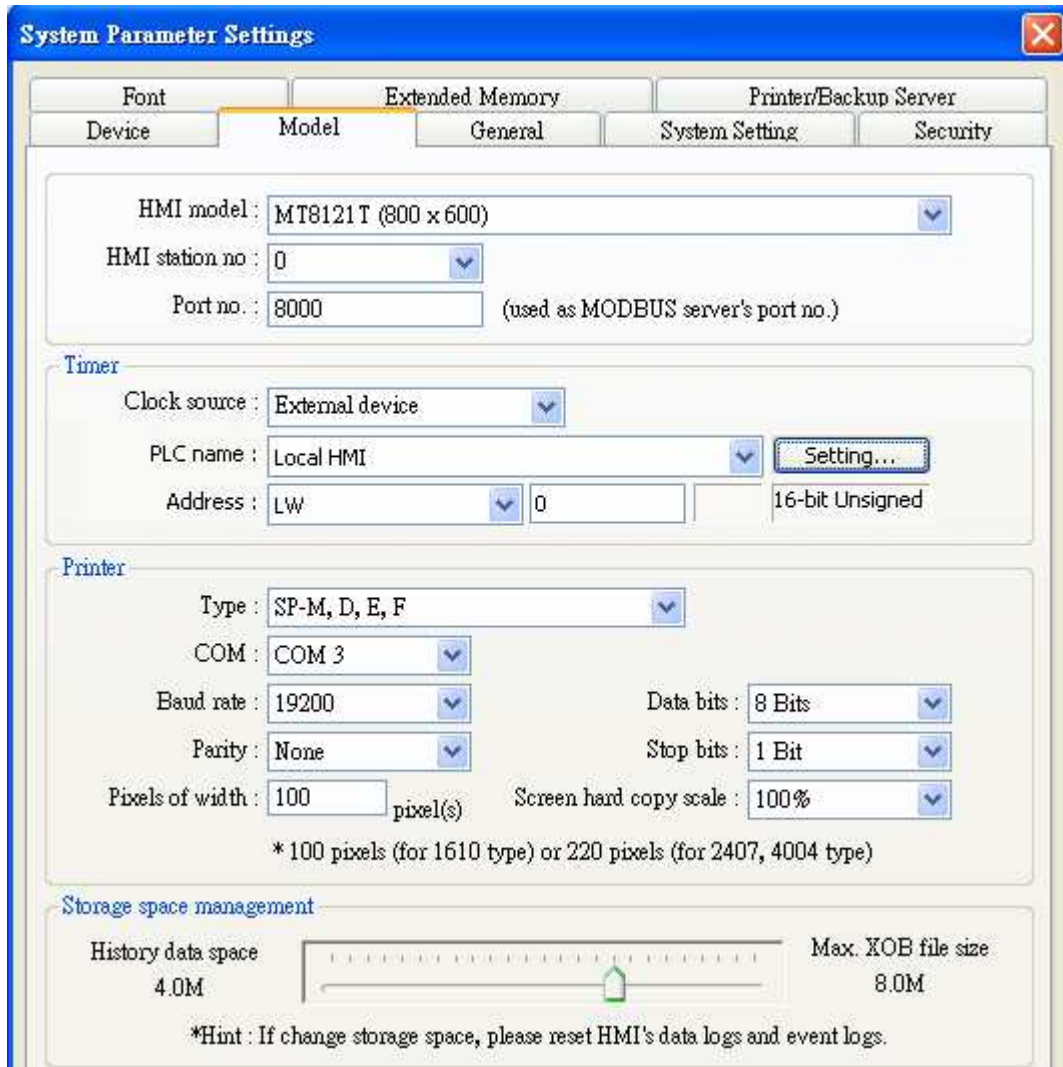

System Parameter Settings

Font Extended Memory Printer/Backup Server

Device Model General System Setting Security

HMI model : MT8121T (800 x 600)

HMI station no : 0

Port no : 8000 (used as MODBUS server's port no.)

Timer

Clock source : External device

PLC name : Local HMI Setting...

Address : LW 0 16-bit Unsigned

Printer

Type : SP-M, D, E, F

COM : COM 3

Baud rate : 19200 Data bits : 8 Bits

Parity : None Stop bits : 1 Bit

Pixels of width : 100 pixel(s) Screen hard copy scale : 100%

* 100 pixels (for 1610 type) or 220 pixels (for 2407, 4004 type)

Storage space management

History data space Max. XOB file size

4.0M 8.0M

*Hint : If change storage space, please reset HMI's data logs and event logs.

Setting	Description
HMI model	Select current HMI model as shown below. <div style="border: 1px solid black; padding: 5px; margin: 10px 0;"> MT6056T/MT8056T (320 x 234) <div style="background-color: #e0e0e0; padding: 2px;">MT6056T/MT8056T (320 x 234)</div> MT6070T/MT8070T (480 x 234) MT6104T/MT8080T/MT8104T (640 x 480) MT8121T (800 x 600) MT8104X (640 x 480) MT8104XH/MT8121X (800 x 600) MT8150X (1024 x 768) MT6070i/8070i (480 x 234) MT8070iH/MT6100i/MT8100i (800 x 480) </div> When changing HMI model and press [OK] , users will be inquired if

	<p>they would like to [Resize pop-up windows or objects].</p> 
HMI station no.	Set the [HMI station no.] used by current HMI. If no specific request is to be made, just use the default number.
Port no.	Set the [Port no.] used by current HMI. It is used as port no. of MODBUS server. If no specific request is to be made, just use the default number.
Timer	<p>[Clock source]</p> <p>To set up the signal for timer object. The time information of timer is used by [Data Sampling], [Event Log]etc. which are objects that need the time records.</p> <p>a. [HMI RTC] means the time signal comes from internal clock of the HMI.</p> <p>b. [External device] means the time signal comes from external device. To correctly set source address of time signal is necessary. Take the illustration below as an example: It indicates the source of time signal is from “TV” of the “Local PLC”. The source address “TV” starts from address 0 contains 6 consecutive words and each of them contains the following information:</p> <p>TV 0 → Second (the limited range: 0~59) TV 1 → Minute (the limited range: 0~59) TV 2 → Hour (the limited range: 0~23) TV 3 → Day (the limited range: 1~31) TV 4 → Month (the limited range: 1~12) TV 5 → Year (the limit range: 1970~2037)</p>

Printer

[Type]
 Display printers supported. For HP PCL Series, it has to be connected through USB interface while other printers through COM port. For more information, please refer to “Chapter 23 Printer Types supported by MT8000”.

Using **[COM]** port to connect printer, users should set accurate parameters. When the type of printer is **[SP-M, D, E, F]**, the **[pixels of width]** has to be set accurately, i.e. the set pixel(s) can not exceed printer’s default setting. Otherwise this printing won’t succeed.

Storage space management

1. Storage space available for the project and history data is 12MB. By adjusting the space of these two parts, users can reach their

(For T series only)

- memory requirements, for example, using smaller sized project to get bigger memory space for historical data. It works contrariwise.
2. Minimum Project size is 6MB; Maximum Project size is 10 MB (default is 8MB). Minimum Historical data size is 2MB; Maximum Historical data size is 6 MB (default is 4MB).
 3. For adjusting storage space, users should erase history data saved in HMI before downloading project file.



5.3 General

Parameters in **[General]** tab determine all properties related to screen display.

System Parameter Settings

Font Extended Memory Printer/Backup Server

Device Model General System Setting Security

Fast selection button

Attribute : Enable Settings...

Position : Left Hide button when HMI starts

Screen saver

Back light saver : 1 minute(s)

Enable back light when alarm occurs

Screen saver : 2 minute(s)

Saver window no. : 10. WINDOW_010

Options

Startup window no. : 10. WINDOW_010

Common window : Above base window Object layout : Nature

Keyboard caret color : RW_A enabled

Event

Use L W9450~9455 as time tags of event logs

BCD

Extra. no. of events : 0

Keyboard

- 50. Keypad 1 - Integer
- 51. Keypad 2 - Integer
- 52. Keypad 3 - Integer
- 53. Keypad 4 - Integer
- 54. Keypad 5 - Integer
- 55. Keypad 6 - Integer
- 56. Keypad 7 - HEX

Add... Delete

Project protection (i series only)

Enable Project key : 111111 (range : 0 ~ 4294901750)

* If this key is different from HMI key, the project won't be executed normally.

* Use L W9046~9047 to change HMI key. LB9046 indicates check result (key error when status is on).

Setting	Description
Fast selection button	Setting all the attributes for fast selection button that is designated as window number 3. a. [Attribute]

	<div data-bbox="778 219 1018 315" data-label="Image"> </div> <p>Enable or disable fast selection window. Select [Enable] and click [Settings...] to set the attributes, including color and text.</p> <p>b. [Position]</p> <div data-bbox="778 510 1018 607" data-label="Image"> </div> <p>Select the position on the screen of HMI where this button appears. If [Left] is chosen, the button will show up on screen bottom-left; if [Right] is chosen, the button will show up on screen bottom-right.</p>
<p>Screen saver</p>	<p>a. [Back light saver] If the screen is left untouched and reaches the time limit set here, back light will be off. The setting unit is minute. Back light will be on again once the screen is touched. If [none] is set, the back light will always be on while using.</p> <p>b. [Screen saver] If the screen is left untouched and reaches the time limit set here. The current screen will automatically switch to a window assigned in [Saver window no.].The setting unit is minute. If [none] is set, this function is disabled.</p> <p>c. [Saver window no.] To assign a window for screen saver.</p>
<p>Option</p>	<p>a. [Startup window no.] Designate the window shown when start up HMI.</p> <p>b. [Common window]</p> <div data-bbox="762 1653 1034 1749" data-label="Image"> </div> <p>The objects in the common window (window 4) will be shown in each base window. This selection determines the layers these objects are placed above or below the objects in the base window.</p> <p>c. [Keyboard caret color]</p>

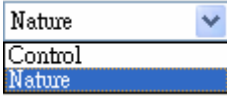
	<p>Set the color of caret that appears when inputting in [Numeric Input] and [Word Input] objects.</p> <p>d. [Object layout]</p> <div data-bbox="783 409 1011 504" style="text-align: center;">  </div> <p>If [Control] mode is selected, when operating HMI, [Animation] and [Moving Shape] objects will be displayed above other kinds of objects neglecting the sequence that the objects are created. If [Nature] mode is selected, the display will follow the sequence that the objects are created, first created be displayed first.</p> <p>e. [RW_A enabled]</p> <p>Enable or disable recipe data RW_A. Enable this, the objects can then control the content of RW_A .The size of RW_A is 64K.</p>
Event	<p>[Extra no. of events]</p> <p>The default number of the event in the system is 1000. If users would like to add more records, the setting value can be modified up to 10000.</p>
Keyboard	<p>Users can select to use different types of keyboards for [Numeric Input] and [Word Input]. Up to 32 keyboards can be added. If users want to design their own keyboard, a window should be designated for creating it. Press [add] after creating, and add the window to the list. For more information, please see “Chapter 12 Key Pad Design and Usage” where also shows how to fix this keyboard in screen instead of adding it to the list.</p>
Project protection (i series only)	<p>User’s project can be restrained and executed on specific HMI (only for i series HMI). Please refer to “Chapter 30 Project protection” for more information.</p>

5.4 System Setting

Parameters in **[System Setting]** tab are for setting up some miscellaneous functions of EasyBuilder.

System Parameter Settings

Font Extended Memory Printer/Backup Server

Device Model General **System Setting** Security

Startup language after redownloading the project : Language 1

Execute init. MACRO when power on

Auto logout

Enable 1 minute(s)

When a user does not operate the HMI for longer than the setting time, the system will automatically logout.

Hide system setting bar Hide mouse cursor

* Use LB-9062 to open hardware setting dialog.

Disable buzzer Prohibit remote HMI connecting to this machine

Disable upload function (effective after rebooting HMI)(or set LB9033 on)

Prohibit password remote-read operation (or set LB9053 on)

Prohibit password remote-write operation (or set LB9054 on)

Use a disconnection icon on relative objects when PLC communication fails

VNC server

Password from project Password : 111111

LW protection

Disable LW remote-write (via COM port or ethernet)

LW range : 0 ~ 99

RW protection

Disable RW remote-write (via COM port or ethernet)

RW range : 0 ~ 999

EasyAccess server

Login EasyAccess server www.ihmi.net

Some functions are duplicated from system tag, such as [Disable buzzer (LB-9019)], [Hide system setting bar (LB-9020)], [Hide mouse cursor (LB-9018)], [Disable upload function (LB-9033)], and [Prohibit remote HMI connecting this machine (LB-9044)]. It means that

user can also operate these functions via system tag. To select a system tag, users can tick **[system tag]** of the **[address]** while adding new object. To check all the system tags, users can visit **[Library]** in EB8000, select **[Tag]** then **[System]**.

[Startup language after redownloading the project]

Set the language to use when start up HMI after redownloading the project.

[Execute init. Macro when power on]

Designate the macro to be executed when HMI power on.

[Auto logout]

If HMI is left unused for longer than the time set here, HMI will logout automatically.

[Use a disconnection icon on relative objects when PLC communication fails]

When using this function and fail to communicate with PLC, this icon will be shown in the lower right corner of the object as shown:

The disconnection icon :



When using this function and fail to communicate with PLC, this icon will be shown in the lower right corner of the object as shown:



[VNC Server]

Set the login password for VNC server.

[LW protection], [RW protection]

If users check **[Disable LW/RW remote-write]** and set the protect range in **[LW/RW range]**, values of this protected range can't be adjusted via remote HMI.

[Easy Access server]

Through this technology, users can easily access to any MT8000i/X connected to the internet and operate them on PC just like holding touch screen in hand.

Unlike most server used in HMI, Easy Access don't need to transmit updated graphic image but real time data only. This makes transmission really quick and efficient.

For further information, please refer to "*EasyAccess*".

5.5 Security

Parameters in **[Security]** tab determine the classes accessible for each user to adjust the objects, and users' password. The security classes of objects are classified from **[A~F]**, and **[none]** for not ticking any class. Up to twelve passwords can be set. Only numeral setting is acceptable for password and the range is 0~999999999.

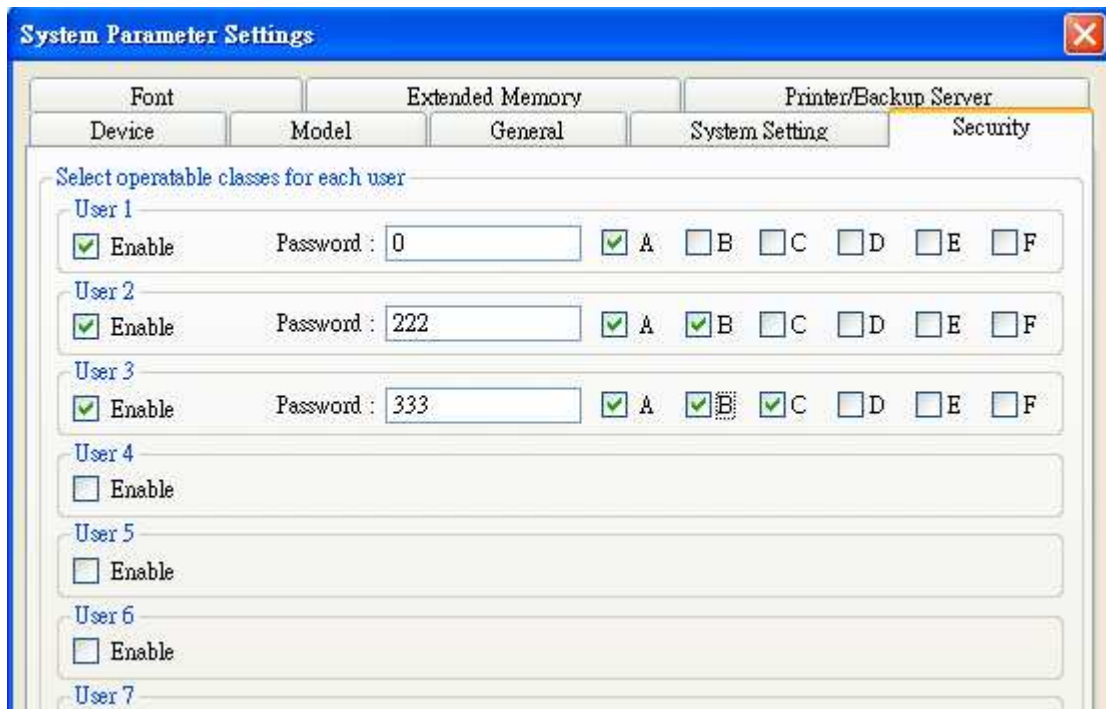

According to the security setting, EB8000 will control the classes accessible for each user to adjust the objects once they input their passwords.

In EB8000, while constructing a project, the security classes of objects are classified from **[A~F]**, and **[None]** and can be set as shown below.

If **[None]** is set, every user can access to adjust this object.

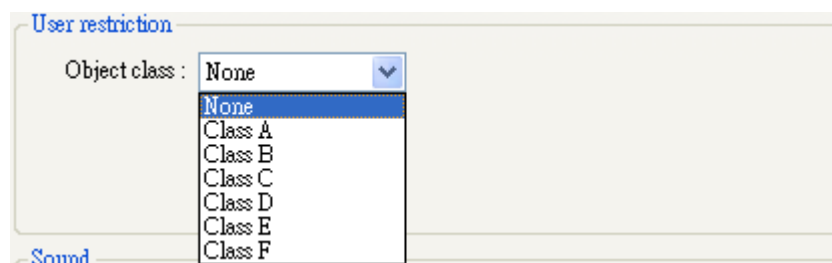

For example, when the security class of User1 is set as below, only objects with class A, C, E and “none” can the user adjust. For more information, please see “Chapter 10 Security of Objects”.



[Project password (MTP file)]

Users can set password to protect the MTP file in **[System parameter] / [Security tab]**.

Users have to input the password set here when they want to edit the MTP file.

(MTP password range: 1~4294967295)

Tick **[Enable]** then click **[Setting]**, and the window is as shown below.



Before editing project, a pop-up window will ask password for access the project.



MTP files are protected by additional encryption, please follow the steps below:

- a. EB8000 V440 or later can open old version EB8000 projects using the password originally set in old version EB8000.
- b. The old version EB8000 can't open the projects that are built in EB8000 V440 or later which are protected by password, if necessary, please disable (don't tick [Enable]) the password first.

5.6 Font

Parameters in **[Font]** tab determine the font of non-ASCII which is used in EB8000.

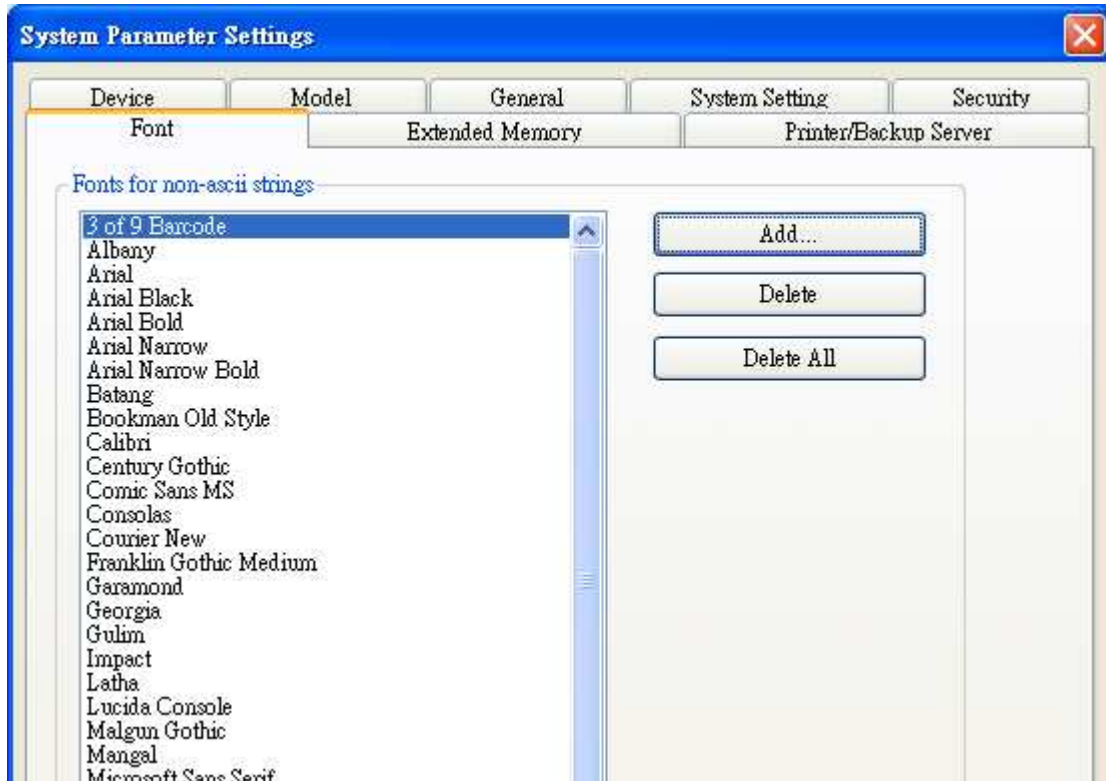

[Fonts for non- strings]

Fonts for non-ASCII strings are listed above. When users use non-ASCII character set or double byte character set (including simplified or traditional Chinese character, Japanese, or Korean) which is not listed in **[Fonts for non-ASCII strings]** table, EB8000 will select a font from the list to substitute for it automatically.

Users can also test which non-ASCII strings of Windows can be used in EB8000 and add them to **[Fonts for non-ASCII strings]** table.

[Line spacing]

Decide the interval between lines in the text.

Line spacing : 0

BL_0

t1
t2
t3

Line spacing = 0

Line spacing : 6

BL_0

t1
t2
t3Line spacing = 6

5.7 Extended Memory

Parameters in **[Extended Memory]** tab determine the path of the extended memory.

The screenshot shows the 'System Parameter Settings' dialog box with the 'Extended Memory' tab selected. The dialog has a blue title bar and a close button in the top right corner. Below the title bar are five tabs: 'Device', 'Model', 'General', 'System Setting', and 'Security'. The 'Extended Memory' tab is active, showing a list of ten extended memory slots (EM0 to EM9). Each slot has a 'File name' field, a radio button for 'SD card', a radio button for 'USB 1', and a radio button for 'USB 2'. The 'USB 1' radio button is selected for all slots. The file names are 'em0.emi' through 'em9.emi'.

Device	Model	General	System Setting	Security
Font	Extended Memory		Printer/Backup Server	

Extended Memory Slot	File name	SD card	USB 1	USB 2
EM0	em0.emi	<input type="radio"/>	<input checked="" type="radio"/>	<input type="radio"/>
EM1	em1.emi	<input type="radio"/>	<input checked="" type="radio"/>	<input type="radio"/>
EM2	em2.emi	<input type="radio"/>	<input checked="" type="radio"/>	<input type="radio"/>
EM3	em3.emi	<input type="radio"/>	<input checked="" type="radio"/>	<input type="radio"/>
EM4	em4.emi	<input type="radio"/>	<input checked="" type="radio"/>	<input type="radio"/>
EM5	em5.emi	<input type="radio"/>	<input checked="" type="radio"/>	<input type="radio"/>
EM6	em6.emi	<input type="radio"/>	<input checked="" type="radio"/>	<input type="radio"/>
EM7	em7.emi	<input type="radio"/>	<input checked="" type="radio"/>	<input type="radio"/>
EM8	em8.emi	<input type="radio"/>	<input checked="" type="radio"/>	<input type="radio"/>
EM9	em9.emi	<input type="radio"/>	<input checked="" type="radio"/>	<input type="radio"/>

Extended Memory is numbered from EM0 to EM9. Method to use extended memory is similar to that of other device type (i.e. LW or RW address). Users can simply select from **[Device type]** list while adding a new object. Size of each extended memory is up to 2G word.

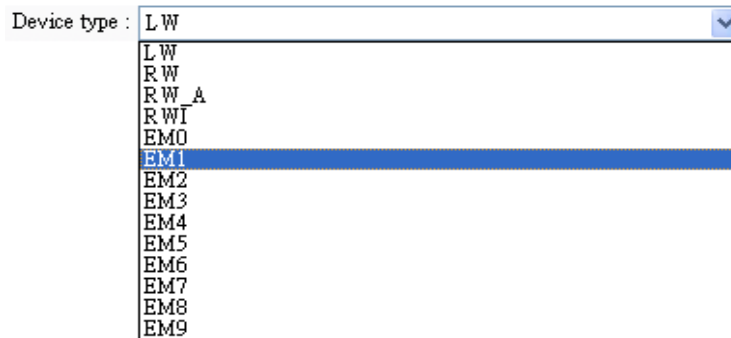

Data in extended memory is stored in **[SD card]**, **[USB1]**, or **[USB2]** in a form of a file. The files in extended memory **[EM0] ~ [EM9]** are entitled as em0.emi~em9.emi. Users can use **RecipeEditor.exe** to open the file and edit the data in the extended memory.

Data in extended memory will not be erased when power is cut, which means next time when user start HMI again, data in extended memory remains just the same before power off. This is similar to Recipe data (EW, RW_A). What is different is that users can select where they want to save the data (SD card, USB1 or USB2)

To read data in extended memory from a removed device, the content of data will be viewed as "0"; if users would like to write data to a removed device, the "PLC no response" message will appear in HMI.

EB8000 supports "hot swapping" function for SD card and USB devices. Users can insert or remove the device for extended memory without cutting the power. With this function, users can update or take data in extended memory.

5.8 Printer/Backup Server

Parameters in **[Printer/Backup Server]** tab are for setting up MT remote printer.

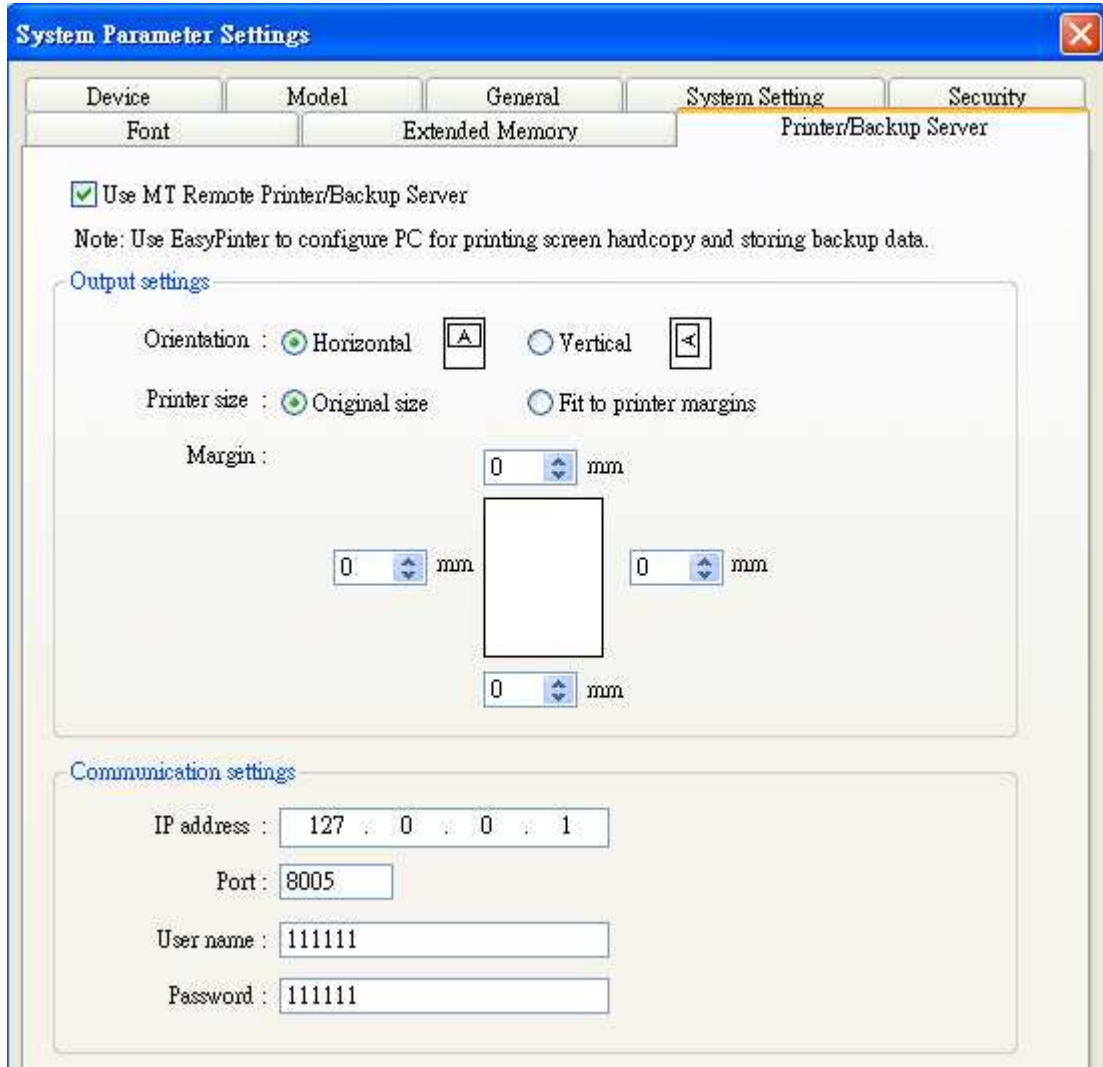

The screenshot shows the 'System Parameter Settings' dialog box with the 'Printer/Backup Server' tab selected. The 'Use MT Remote Printer/Backup Server' checkbox is checked. A note below it reads: 'Note: Use EasyPrinter to configure PC for printing screen hardcopy and storing backup data.' The 'Output settings' section includes radio buttons for 'Horizontal' (selected) and 'Vertical', radio buttons for 'Original size' (selected) and 'Fit to printer margins', and four spin boxes for 'Margin' (top, bottom, left, right) all set to 0 mm. The 'Communication settings' section includes text boxes for 'IP address' (127.0.0.1), 'Port' (8005), 'User name' (111111), and 'Password' (111111).

Setting	Description
Output settings	<p>[Orientation] Set how will words or pictures be printed out, [horizontal] or [vertical].</p> <p>[Printer size] Set to print out in original size or to fit the set printer margins.</p> <p>[Margin] Set the top, bottom, right and left margin width.</p>
Communication settings	<p>[IP address] Assign the IP address of a remote printer via network.</p>

	<p>[Port], [User name], [Password] Assign the access information. Port can be set from 1 to 65535. Maximum length of user name or password is 12 characters.</p>
--	---

※ Please refer “Chapter 26 Easy Printer” for more information.

Chapter 6 Window Operations

A window is a basic element in a project. With a window, all kinds of information like objects, pictures, and text can be shown on HMI screen. Generally, there's more than one window in a project, many windows will be constructed in one project. 1997 windows numbered from 3~1999 in EasyBuilder Pro can be built and edited. For how many windows can be used in one project, it depends on the storage size for windows of HMI. For example, the storage size of i series HMI for windows is 16MB, then the size of windows or screens constructed cannot exceed 16MB. Under this limit users can make most use of it to create as many windows as possible.

6.1 Window Types

There are 4 types of windows, each with different functions and usages:

- (1) Base Window (2) Fast Selection Window (3) Common Window (4) System Message Window**

6.1.1 Base Window

The most frequently used window, used as:

- a. main screen
- b. background for other windows
- c. keyboard window
- d. pop-up window for [function key] object.
- e. pop-up window for [direct window] and [indirect window] objects.
- f. screen saver

The start up screen shown on the right is a Base Window.



■ Base window should be in the same size as the HMI screen. Therefore, the resolution of base window and HMI should be identical.

6.1.2 Fast Selection Window

Window no. 3 is defined as the Fast Selection Window. This window can coexist with base window. Generally speaking, it is used to place the frequently-used operation buttons as shown below:

The **[Shortcut]** button is a fast selection button used to show / hide fast selection window.



Fast Selection Button setting dialog: **[System Parameter Settings / General]**

Or use system registers to control:

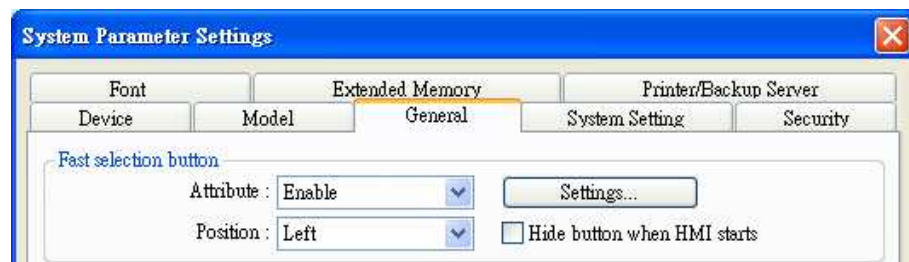

- [LB-9013] FS window control [hide(ON)/show(OFF)]
- [LB-9014] FS button control [hide(ON)/show(OFF)]
- [LB-9015] FS window/button control [hide(ON)/show(OFF)]

6.1.3 Common Window

Window no. 4 is the default Common Window. Objects on this window will be displayed on other base windows, but it does not include popup windows. Therefore, objects on different windows, whether shared or same, will be placed on common window, for example, the product logo, or a common button.

When system is in operation, select **[Function Key] / [Change common window]** to change the source of common window. For example, change the common window from window 4 to window 20.

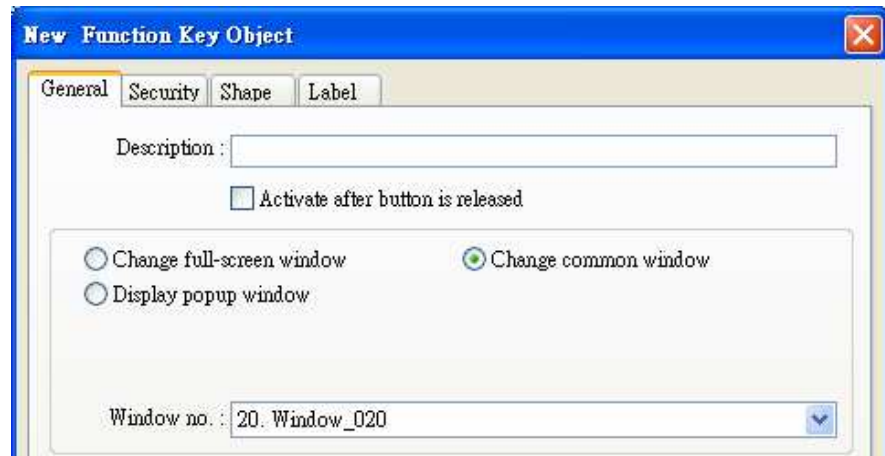

In **[Option]/[Function Properties]** select whether or not to **[Display Common Window objects on Base Windows]** when editing project. This can avoid overlapping objects on base window with objects on common window.

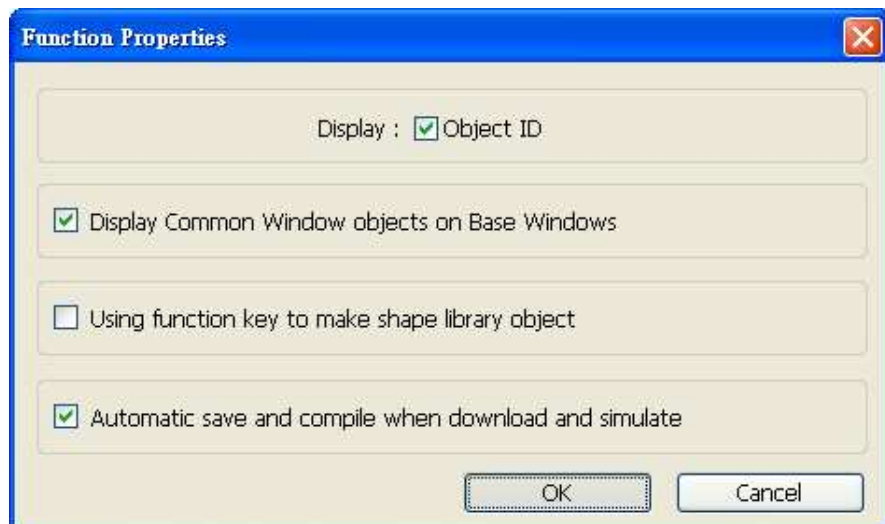

6.1.4 System Message Window

Windows No. 5,6,7,8 are the default System Message Windows:

[Window No. 5: PLC Response]

When the communication between PLC and HMI is disconnected, this message window will pop up automatically right on the base window opened previously.

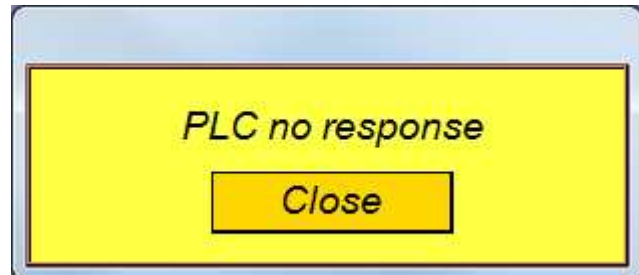

■“PLC no response” window can be set not to pop-up using system reserved registers. Please refer to “Chapter 22 System Reserved Words & Bits”.

[Window No. 6: HMI Connection]

When failing to connect HMI with remote HMI, this message window will pop up automatically.



[Window No. 7: Password Restriction]

If user attempts to control an object without authorization, this window may pop up as a warning or not depending on how this object is set originally.



[Window No.8: Storage Space Insufficient]

When HMI built-in memory, USB disk or SD card run out of storage space, this message window will pop up automatically. (When system detects that memory space left is under 4MB)

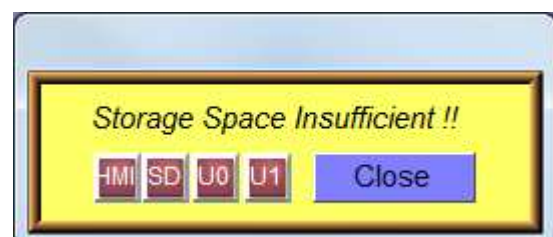

Users can use system address tags to view the free memory space in HMI, USB disk, or SD card device.

[LW-9072] HMI current free space (K bytes)

[LW-9074] SD/CF current free space (K bytes)

[LW-9076] USB 1 current free space (K bytes)

[LW-9078] USB 2 current free space (K bytes)

For checking which device is insufficient in space while the insufficiency occurs, the following system address tags can be used.

[LB-9035] HMI free space insufficiency alarm (when ON)

[LB-9036] SD/CF card free space insufficiency alarm (when ON)

[LB-9037] USB 1 free space insufficiency alarm (when ON)

[LB-9038] USB 2 free space insufficiency alarm (when ON)

The text shown on windows no. 5~8 can be adjusted by users to fit what is needed, making the message easier to be understood by the operators.



- A screen can display 16 pop-up windows simultaneously in maximum including System Message Window, Direct Window and Indirect Window.
 - A window can only be displayed once simultaneously. That is, users cannot use 2 Direct (Indirect) windows to open the same window on one base window at the same time.
 - Windows 3~9 are for system use only while windows 10~1999 are for users to define.
-

6.2 Create, Set, and Delete a Window

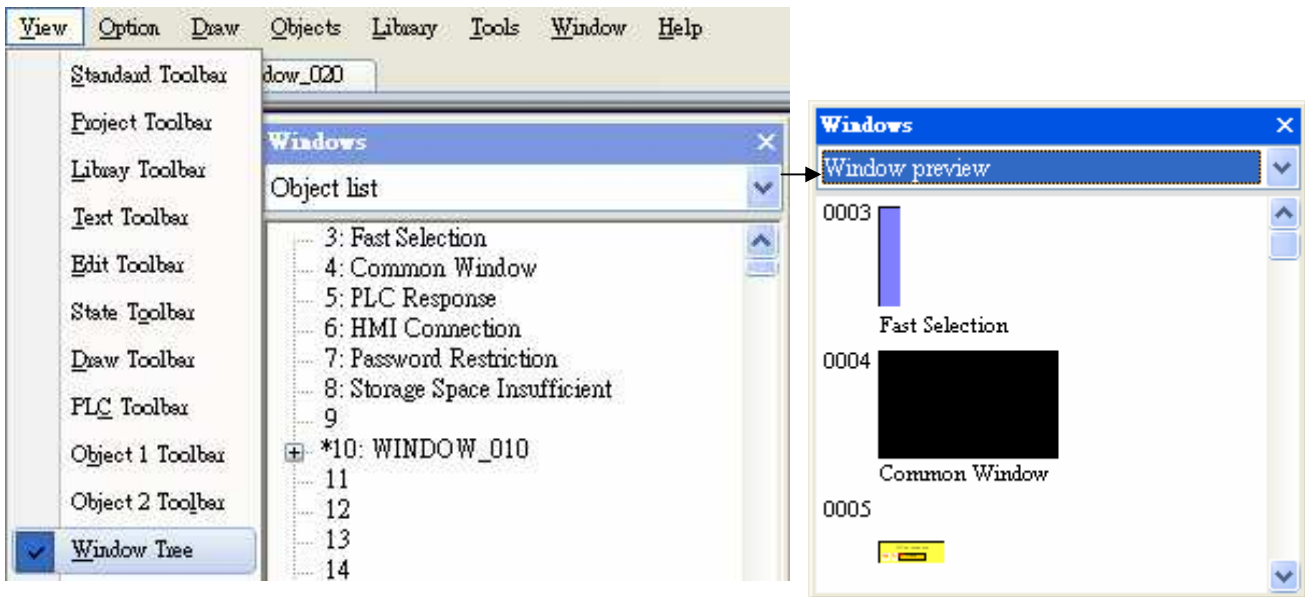

Go to **EasyBuilder Pro / [View] / [Window Tree]** to check the built windows.

[Object List] displays window number and defined window names. The currently opened and edited window will contain a (*) mark, press the (+) beside the window number to see the objects, object ID, addresses and descriptions this window contains.

[Window Preview] displays windows in small pictures.

6.2.1 Creating and Setting a Window

■ Way 1

On window tree right click on a window number then select **[New]**.

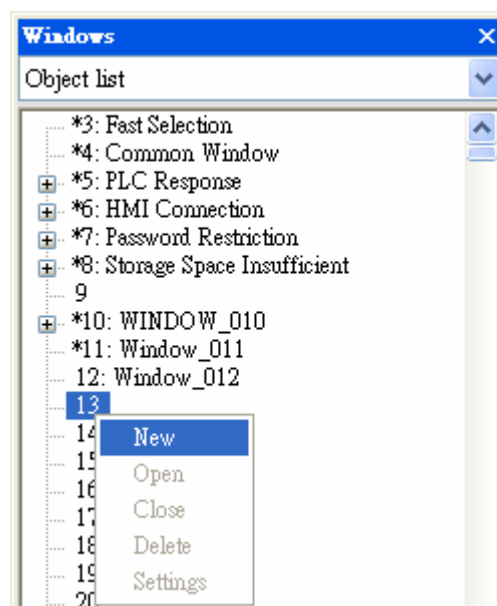

[Name] The name will appear on the title bar and also in window tree.

[Window no.]
3 ~ 1999

Set base window size identically to HMI resolution.

[Underlay window]
Refer to the description below.

[Popup window]
Base window can also be used as pop-up window. Use **[X]** and **[Y]** to set the coordinates indicate where on the screen will this base window pop up. The origin of the coordinates is the upper-left corner of the screen.

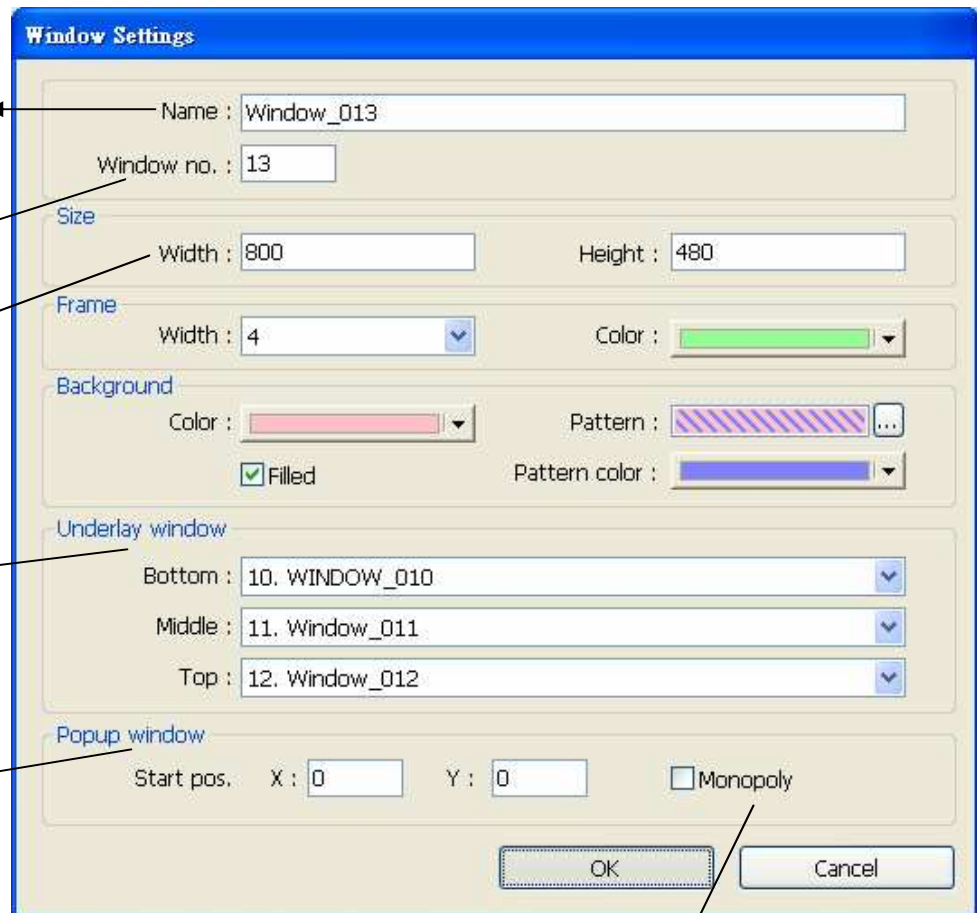

[Monopoly]

If the option is checked, when a base window used as a pop-up window appears, users are not allowed to operate other windows before this base window is closed. If a base window is used as a keyboard window, "Monopoly" is automatically enabled.

[Underlay window]

One object can be placed on different windows (but not all windows). Underlay Window can be seen as an extra Common Window. The objects are placed on the Base Window where they are built. Up to three Underlay Windows can be defined by users.

Underlay Window is a base window which can be displayed simultaneously with the base window which calls it up. Up to three base windows can be specified as underlay windows for each base window, from **[Bottom]** to **[Top]**. The objects (but not the backgrounds) on underlay windows are displayed in this order on base window.



■ Objects in the background can't be edited on the window they are shown, to edit objects on underlay windows, open the window they are built on using EasyBuilder Pro editing software.

■ Way 2

EasyBuilder Pro / [Window] / [Open Window]

Click **[New]** to select the window style to be built and click **[OK]**.

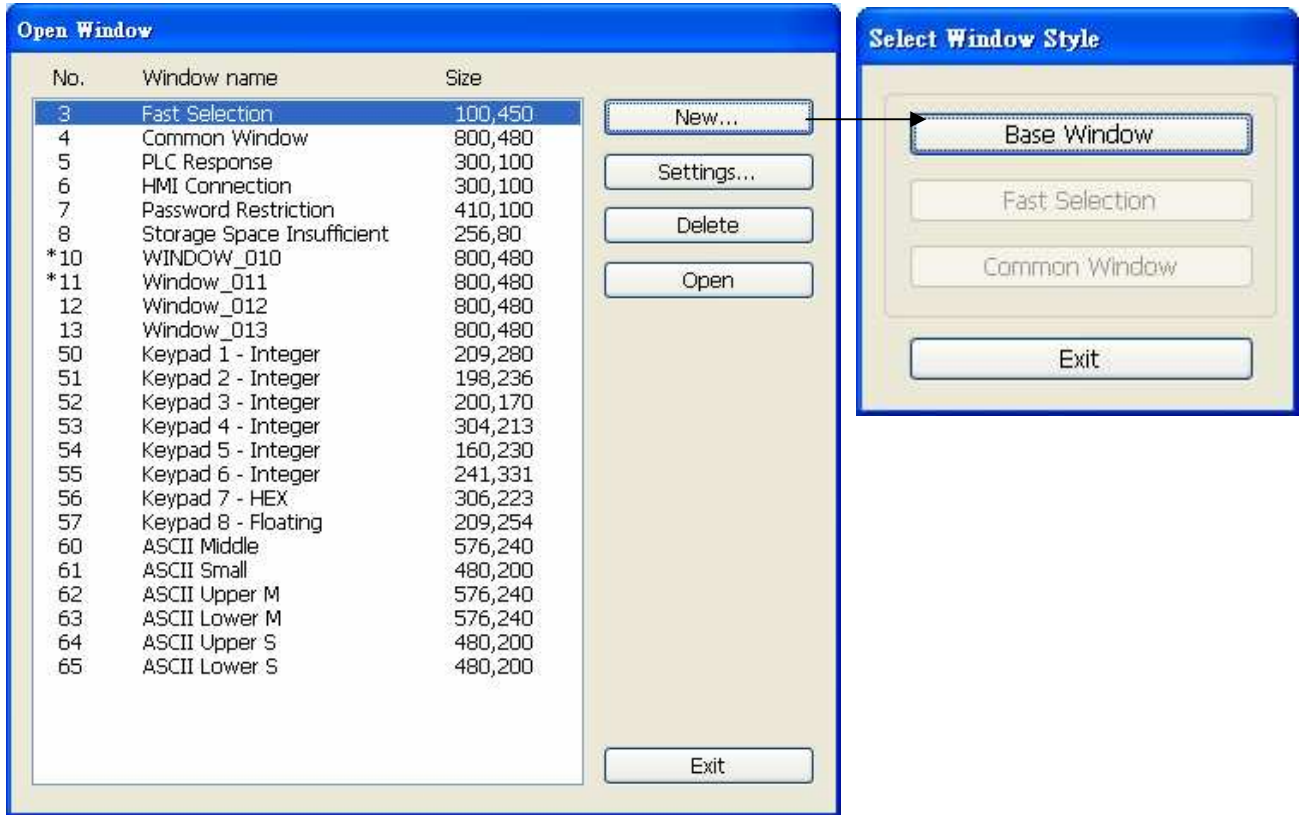

There are three ways to call up **[Window Settings]** dialog:

■ Way 1

Right click on the window number in the window tree and select **[Settings]**.



■ Way 2

EasyBuilder Pro / [Window] / [Open Window] click on the window to be set and then click **[Settings]**.

■ Way 3

On the window, right click when no object is selected, and click **[Attribute]**.

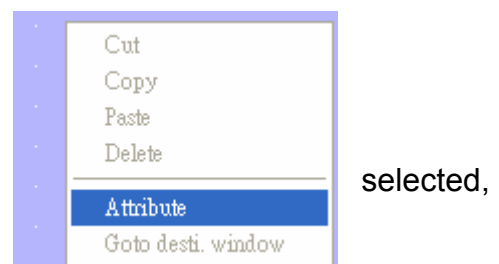

6.2.2 Open, Close and Delete a Window

Open an existing window:

1. Double click on the window number in window tree.
2. In window tree select the window to be opened -> right click -> click **[Open]**.

Close or delete an existing window:

Nearly the same procedure as the above, please note that to delete a window, it has to be closed first.

Chapter 7 Event Log



7.1 Event Log Management



Alarm Bar / Alarm Display / Event Display

Using these objects to view the process of the whole event from triggering→waiting for processing→until alarm stops. Define event content first.

Category

EasyBuilder Pro classifies events by dividing them into 0 ~ 255 categories. Select one category to add or view event log. In [] it shows how many events are in this category.

History files

Specify the storage device of an event log. However, when simulating the project on PC, the files will be saved under the installation directory. For USB numbering, the first inserted will be USB1, the second will be USB2, regardless of the interface position.

Alarm (Event) Log

Category : All [2]

No.	Category	Text	Mode	Condition	Read address	Notification address	Buzzer
1	0	Event 0	WORD	< 0.00	Local HMI : LW-0	Disable	Disable
2	0	Event 1	BIT	ON	Local HMI : LB-0	Disable	Disable

Enable back light when alarm occurs

History files

Save to HMI memory Save to SD card Save to USB 1 Save to USB 2

Preservation limit Days of preservation : 2 day(s)

Print

Sequence no.

Event trigger time HH:MM:SS HH:MM DD:HH:MM

Event trigger date MM/DD/YY DD/MM/YY DD.MM.YY YY/MM/DD

Buttons: New..., Insert..., Delete, Settings..., Copy, Paste, Export..., Import..., Exit

[Preservation limit]

This setting determines how many days the data to be preserved. For example, the **[Days of preservation]** is set to two days, which means HMI memory will keep the data of yesterday and the day before yesterday. Data that is not built in this period will be deleted automatically to prevent the storage space from running out.

Print

To enable this setting, please finish the settings of printer in **[System Parameter Settings]/[Model]**.

7.1.1 Excel Editing

Use Excel to edit **[Event Log]**.



Click on the Excel icon on Event Log setting dialog to open the Excel template for editing. This template is under installation directory - EventLogExample.xls and includes ready made dropdown lists and validation mechanism.

	A	B	C	D	E	F	G	H	I	J	K
1	Category	Priority level	Address type	PLC name	Device type	System tag	User-defined tag	Address	Index	Data Format	Enab
2	0	Middle	Word	Local HMI	EMO	False	False	22	null	32-bit Signed	True
3	1	Low	Bit	Local HMI	LB-9009 : initialized as ON	True	True	122	IDX 1	16-bit BCD	False
4	2	High	Word	Local HMI	RW1	False	False	2222	IDX 4	32-bit BCD	True
5										16-bit BCD	
6										16-bit Signed	
7										16-bit Unsigned	
8										32-bit Signed	
9										32-bit Unsigned	
10										32-bit Signed	



1. [System tag] and [User-defined tag] can not be set to true simultaneously, otherwise, the system will view [System tag] to be true, and [User-defined tag] to be false. If setting [User-defined tag] as [Device type], please set [System Tag] to be false.
2. [Color] format is R:G:B, each should be an integer form 0 ~ 255.
3. When setting [User-defined tag] to be true, if the system compares the [Device type] with the user-defined tag in system, and no suitable tag is found, the system will set the user-defined tag in event log to be false.
4. Before importing Library (Label Library / Sound Library), please make sure library names exist in the system, otherwise the system will simply use the file name of the imported Excel file.

7.2 Create a New Event Log

7.2.1 Alarm (Event) Log General Settings

Click **[New]**, appears the **[Alarm (Event) Log]** dialog which includes two tabs, go to **[General]** tab.

[Category]

Select event category, 0 ~ 255.

[Priority level]

When the number of Event Log equals to the max number available in the system (default 1000), the lower priority events will be deleted and new events will be added in.

[Read address]

System reads data from this address to check if the event matches the trigger condition.

[Notification]

When enabled, system will set the specified register to ON or OFF when the event is triggered.

[Condition]

When **[Bit]** is selected, Event Log will detect the ON or OFF state of a Bit address.

The screenshot shows the 'Alarm (Event) Log' dialog box with the 'General' tab selected. The 'Category' is set to 0 and 'Priority level' is Low. 'Address type' is Word. Under 'Read address', the PLC name is 'Local HMI', the address is 'LW' with value '0', and it's a '16-bit Unsigned' register. The 'Notification' section has 'Enable' checked, with 'Set ON' and 'Set OFF' radio buttons. The 'Condition' section is set to 'Trigger if value is: ==' with a value of '0', an 'In tolerance' of '0.1', and an 'Out tolerance' of '0.2'. Buttons for 'OK', 'Cancel', and 'Help' are at the bottom.

When **[Word]** is selected, Event Log will detect the value of a Word address to check if it equals to, greater than, or less than a specified value.

Example 1

This close-up shows the 'Condition' section of the dialog. The 'Trigger if value is:' dropdown is set to '==' and the value is '30'. The 'In tolerance' is set to '1' and the 'Out tolerance' is set to '2'.

The setting above indicates:

When **[Read address]** value is greater than or equals to 29 (= 30 - 1) and less than or equals to 31(= 30 + 1), the event will be triggered. The trigger condition:

$29 \leq [\text{Read address}] \text{ value} \leq 31$

After the event is triggered, when **[Read address]** value is greater than $32 (= 30 + 2)$ or less than $28 (= 30 - 2)$ the system will return to normal condition:

$[\text{Read address}] \text{ value} < 28$ or $[\text{Read address}] \text{ value} > 32$

Example 2

Condition

Trigger if value is :

In tolerance : Out tolerance :

The setting above indicates:

When **[Read address]** value is less than $29 (= 30 - 1)$ or greater than $31 (= 30 + 1)$, the event will be triggered. The trigger condition:

$[\text{Read address}] \text{ value} < 29$ or $[\text{Read address}] \text{ value} > 31$

After the event is triggered, when **[Read address]** value is greater than or equals to $28 (= 30 - 2)$ and less than or equals to $32 (= 30 + 2)$ the system will return to normal condition:

$28 \leq [\text{Read address}] \text{ value} \leq 32$

7.2.2 Alarm (Event) Log Message Settings

Alarm (Event) Log **[Message]** tab:

[Content]

The text content of Event Log shown in [Alarm Bar], [Alarm Display] and [Event Display] Please see the examples next page.

[Font] / [Color]

The font and color can be set differently for each event. The font and color shown in [Alarm Bar], [Alarm Display] or [Event Display] come from this setting.

[Write value for Event/Alarm Display object]

When an event in [Event Display] or [Alarm Display] is acknowledged, the value is written to the assigned address.

[Sound]

When enabled, a designated sound will be played when an event is triggered. Continuous beep can be set which will only stop when the event is acknowledged or recovered.

When using continuous beep for Event Log, a delay period can be set between triggering the alarm and the start of beeping.

An illustration of how the beep is related to the event:

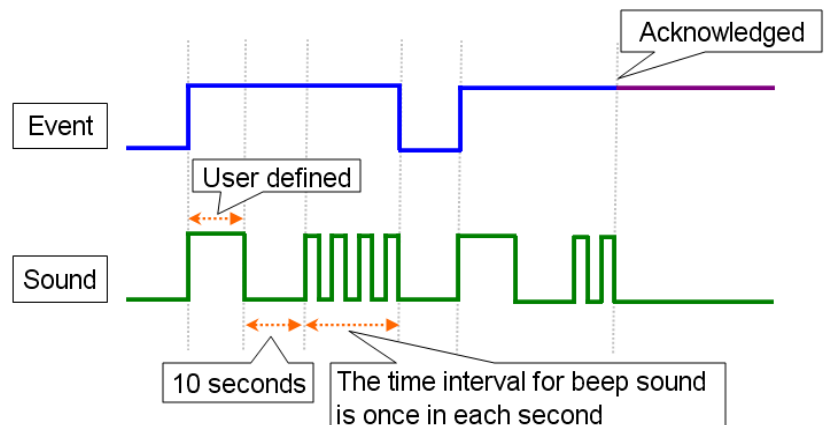
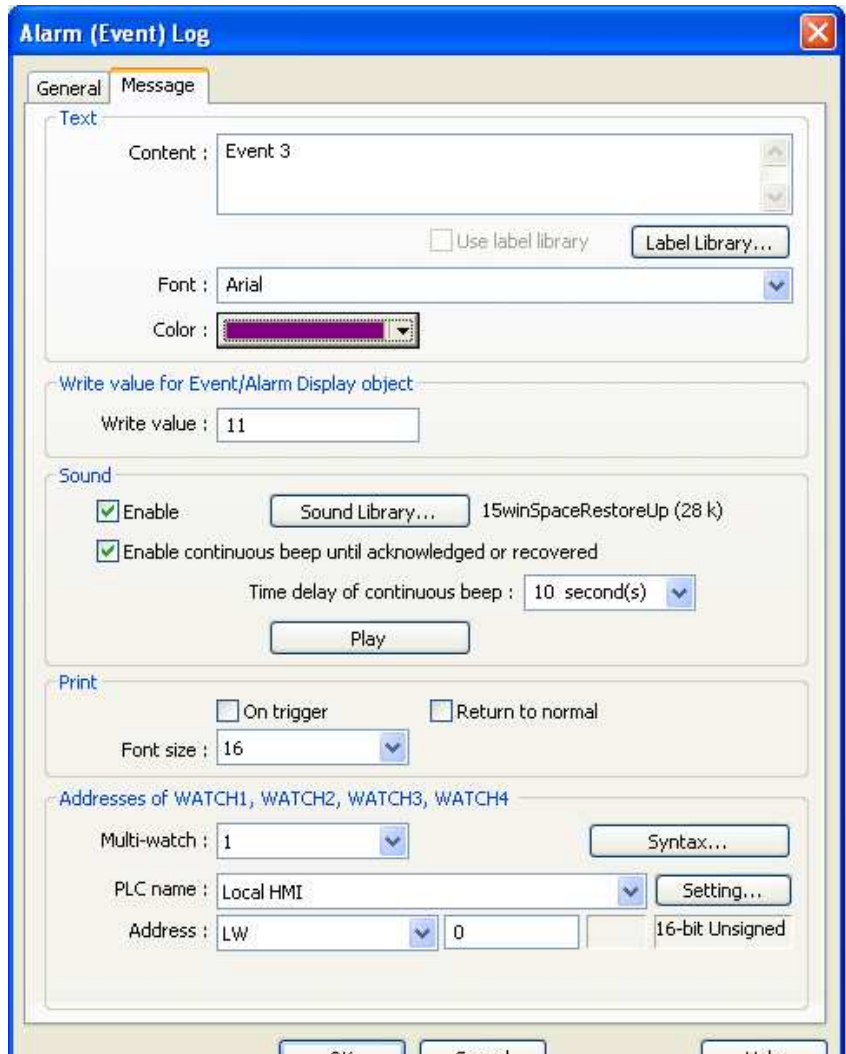

Example 1

The data of LW address of the triggered event can be included in the content:

Format: **%#d** (% = initial sign # = address d = end sign)

When an event is triggered, if LW-20 = 13:

Setting: "High Temperature = %20d" → Display: "High Temperature = 13"

Example 2

When an event is triggered, data in certain device type can also be shown in the content. This device type should be the same as that of the **[Read address]** of Event Log, take MW address as example:

Format: **\$#d** (\$ = initial sign # = address d = end sign)

When an event is triggered, if MW-15 = 42:

Setting: "High Temperature = \$15d" → Display: "High Temperature = 42"

[Address of Watch]

Click **[Syntax]** to edit and display the value in watch address when the event is triggered. Up to four watch addresses can be set.

Syntax of Watch Function

Use the below syntax to embed PLC data in the content of an event log.

Usage

%(WATCH#)d.*	Display signed decimal integer
%(WATCH#)f.*	Display floating point
%(WATCH#)s	Display string
%(WATCH#)X	Display unsigned hexadecimal integer, using "ABCDEF."
%(WATCH#)x	Display unsigned hexadecimal integer, using "abcdef."

where # : watch no., range : 1~4
 * : the number of digits after the decimal point.
 If * is 0, ".*" can be ignored.

Examples

- 1.Pressure = %(WATCH1)d.1
- 2.Temperature1 is %(WATCH1)f.2, Temperature2 is %(WATCH2)f.2
- 3.Alarm : IP = %(WATCH1)X : %(WATCH2)X : %(WATCH3)X : %(WATCH4)X
- 4.Counter is %(WATCH3)d
- 5.Message = %(WATCH1)s, Index = %(WATCH3)d

7.3 Event Log Relevant Registers



EasyBuilder Pro provides the following system tags to manage the Event Log:

Address	Description
LB-9021	reset current event log (set ON)
LB-9022	delete the earliest event log file on HMI memory (set ON)
LB-9023	delete all event log files on HMI memory (set ON)
LB-9024	refresh event log information on HMI memory (set ON)
LB-9034	save event/data sampling to HMI, USB disk, SD card (set ON)
LB-9042	acknowledge all alarm events (set ON)
LB-9043	unacknowledged events exist (when ON)
LB-11940	delete the earliest event log file on SD card (set ON)
LB-11941	delete all event log files on SD card (set ON)
LB-11942	refresh event log information on SD card (set ON)
LB-11943	delete the earliest event log file on USB 1 (set ON)
LB-11944	delete all event log files on USB 1 (set ON)
LB-11945	refresh event log information on USB 1 (set ON)
LB-11946	delete the earliest event log file on USB 2 (set ON)
LB-11947	delete all event log files on USB 2 (set ON)ON
LB-11948	refresh event log information on USB 2 (set ON)
LW-9060	(16bit) : no. of event log files on HMI memory
LW-9061	(32bit) : size of event log files on HMI memory
LW-9450	(16bit) : time tag of event log - second
LW-9451	(16bit) : time tag of event log - minute
LW-9452	(16bit) : time tag of event log - hour
LW-9453	(16bit) : time tag of event log - day
LW-9454	(16bit) : time tag of event log - month
LW-9455	(16bit) : time tag of event log - year
LW-10480	(16bit) : no. of event log files on SD card
LW-10481	(32bit) : size of event log files on SD card
LW-10483	(16bit) : no. of event log files on USB 1
LW-10484	(32bit) : size of event log files on USB 1
LW-10486	(16bit) : no. of event log files on USB 2
LW-10487	(32bit) : size of event log files on USB 2

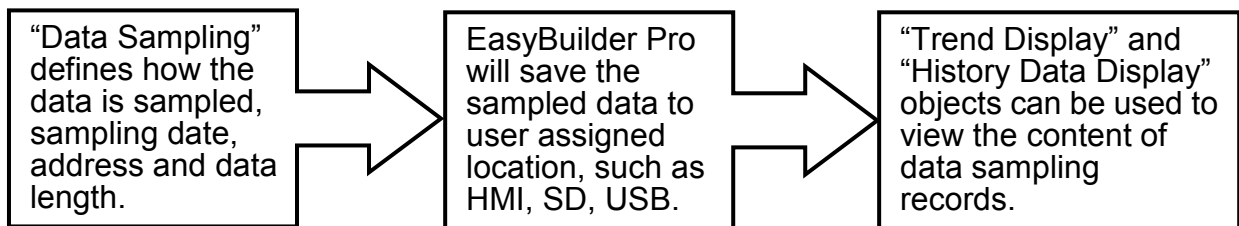
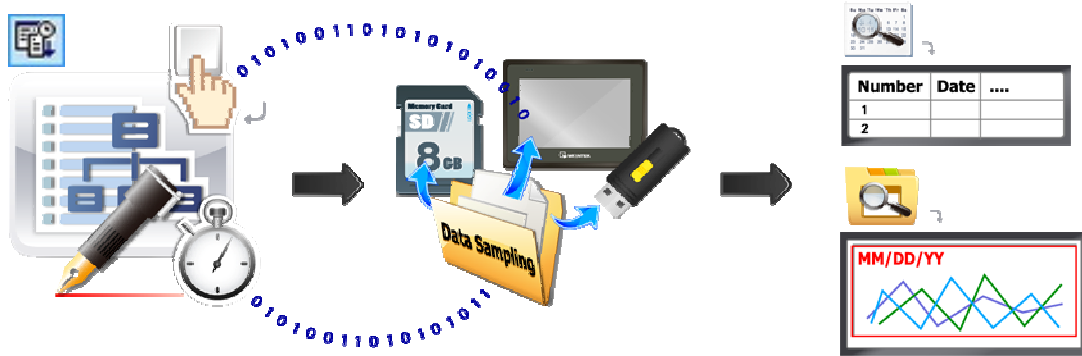
Chapter 8 Data Sampling



8.1 Data Sampling Management

Please define how the data is sampled before using  Trend Display or  History Data Display to review the content of Data Sampling.

1. Click on the object icon

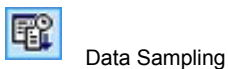

2. Click **[New]** to specify relevant settings.

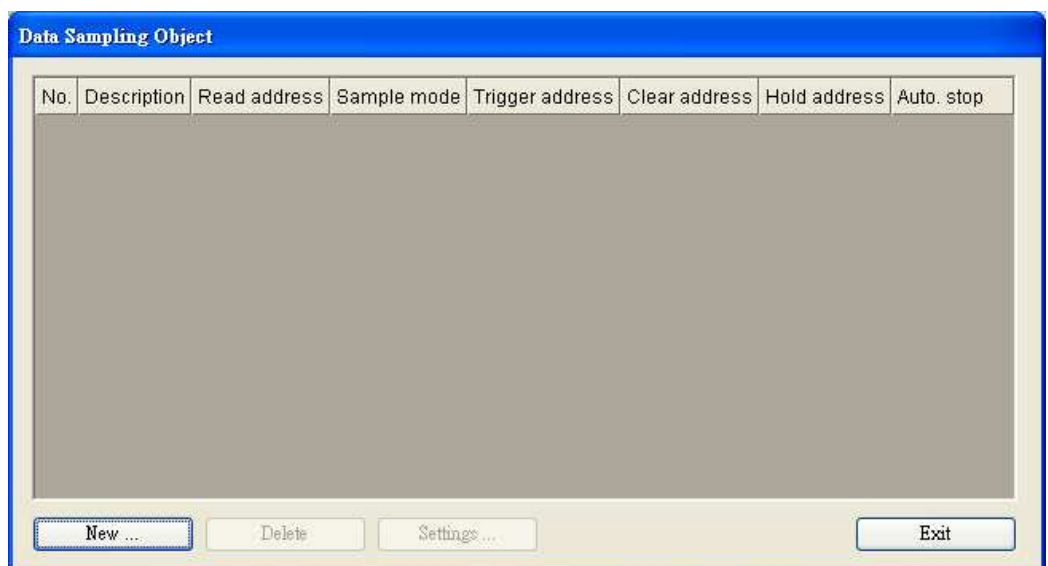

8.2 Create a New Data Sampling

Click on any of the fields on the dialog box for detail.

[Sampling mode]

[Time-based] mode samples data in a fixed frequency. The **[Sampling time interval]** can be defined from every “0.1 second(s)” to every “120 mins”.

[Trigger-based] mode uses the status of specific address to trigger Data Sampling.

[Mode]

Conditions to trigger Data Sampling:

[OFF -> ON] Trigger when the status of assigned address changes from OFF to ON.

[ON -> OFF] Trigger when the status of assigned address changes from ON to OFF.

[OFF <-> ON] Trigger when the status of assigned address is changed.

[Read address]

Select a device type to be the source of Data Sampling.

[Data Record]

Max. data records : 1000

Max. number of data records can be saved by

one Data Sampling in one day is 86400. (1 record per second for 24hours) If **[sampling time interval]** is set to “0.1 second” then the max number of data records is 86400 only.

Auto. stop

Condition	[Max. data records]: “10” & don’t tick [Auto. stop]	[Max. data records]: “10” & tick [Auto. stop]
Trend Display Real Time	Delete earlier sampled data and display the latest 10 records on “Trend Display”.	Stops after reaching 10 data records.
Trend Display Historical	Keep on sampling data and display all history data on “Trend Display”.	Stops after reaching 10 data records.
History Data Display	Keep on sampling data and display all history data on “History Data Display”.	Stops after reaching 10 data records.
Data Sampling	Keep on sampling new data.	Stops sampling after reaching 10 data records.

A Data Sampling may include more than one type of records. Data Sampling in EasyBuilder Pro is able to retrieve different types of records at the same time. Users can define the content of Data Sampling. As shown, user defines three types of data with data length 4 words in total. In this way, EasyBuilder Pro retrieves a 4-words-lengthed data each time from the assigned address to be the content in one Data Sampling.



If you have run the simulation and the sampling data is saved in the record, then you want to change the format of sampling date, be sure to delete previous data record in EasyBuilder Pro installation directory to avoid the system misinterpret the old data record.

[Clear address]

If the status of the assigned address is set ON, the data obtained by “Trend Display”

[real-time] mode will be cleared and the number

of data sampling returns zero. This won't affect the sampled data that is already saved in file.

[Hold address]

If the status of the assigned address is set ON, sampling will be paused until the status of assigned address returns to OFF.

[History files]

[Save to HMI]

Save Data Sampling to HMI only when its size reaches “4kb”, or, use [LB-9034] to force storing data.

[Save to SD card / USB1 / USB2]

Save Data Sampling to the specified external device.

Note that the USB ports are not designated as no.1 or no.2. The USB device plugged in first is USB1; the USB device plugged in next is USB2.

[Folder name]

Specify Data Sampling file name which **must be in ASCII characters**.

The folder name will be written as: **[Storage Location] \ [Folder Name] \ yyyyymmdd.dtl**

Preservation limit Days of preservation : day(s)

This determines how many days the data to be preserved. “2” days means the data of yesterday and the day before yesterday will be kept. Data not built in this period will be deleted to prevent the storage space from running out. EX: if today were July 1st, data of June 30th and June 29th will be preserved and data of June 28th be deleted.



When running simulation on PC, all data sampling will be saved to the **datalog** folder which is under the directory of **[Storage location]**.

8.3 System Registers Relevant to Data Sampling

EasyBuilder Pro provides the following system registers for data sampling management:

Address	Description
LB-9025	delete the earliest data sampling file on HMI memory (set ON)
LB-9026	delete all data sampling files on HMI memory (set ON)
LB-9027	refresh data sampling information on HMI memory (set ON)
LB-9034	save event/data sampling to HMI, USB disk, SD card (set ON)
LB-11949	delete the earliest data sampling file on SD card (set ON)
LB-11950	delete all data sampling files on SD card (set ON)
LB-11951	refresh data sampling information on SD card (set ON)
LB-11952	delete the earliest data sampling file on USB 1 (set ON)
LB-11953	delete all data sampling files on USB 1 (set ON)
LB-11954	refresh data sampling information on USB 1 (set ON)
LB-11955	delete the earliest data sampling file on USB 2 (set ON)
LB-11956	delete all data sampling files on USB 2 (set ON)
LB-11957	refresh data sampling information on USB 2 (set ON)
LW-9063	(16bit) : no. of data sampling files on HMI memory
LW-9064	(32bit) : size of data sampling files on HMI memory
LW-10489	(16bit) : no. of data sampling files on SD card
LW-10490	(32bit) : size of data sampling files on SD card
LW-10492	(16bit) : no. of data sampling files on USB 1
LW-10493	(32bit) : size of data sampling files on USB 1
LW-10495	(16bit) : no. of data sampling files on USB 2
LW-10496	(32bit) : size of data sampling files on USB 2

Chapter 9 Object General Properties

The contents of **[general]** properties settings of an object include:

1. Selecting the connected PLC.
2. Setting reading and writing address
3. Using shape library and picture library
4. Setting text content
5. Adjusting profile size

9.1 Selecting PLC

It is required to designate which PLC to operate while using some objects as shown below. **[PLC name]** represents the controlled PLC. In this example there are 2 PLC: “Local HMI” and “Allen-Brandley DF1.” These listed available PLC devices are sourced from **[Device List]** in **[System Parameters Settings]**.

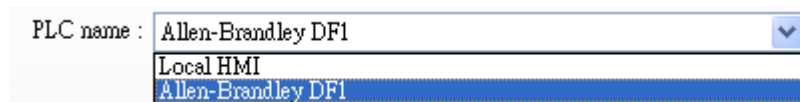

9.1.1 Setting the Reading and Writing Address

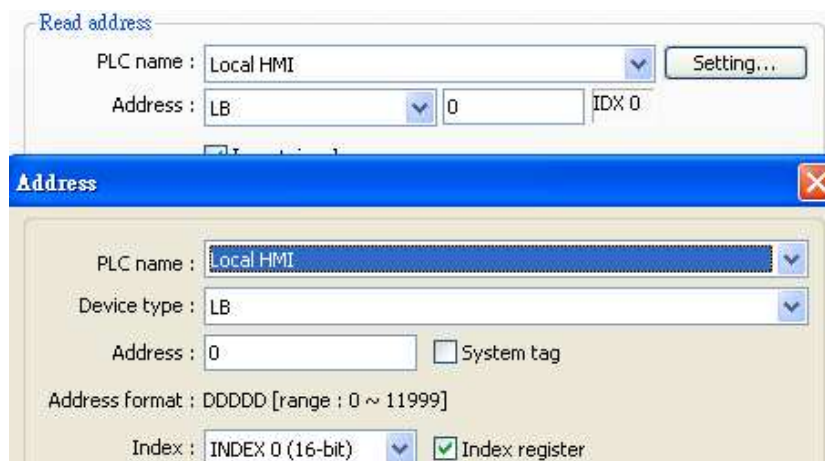

The picture above shows a reading address or writing address contains:

[PLC name]

This is for selecting device type. Different PLC are with different selections of [device type].

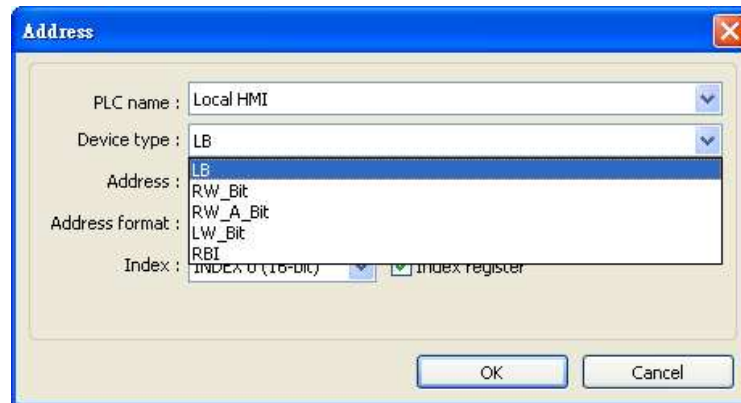

[Address]

Set the reading and writing address.

[System tag]

Address tag includes “system tag” and “user-defined tag.” Click [Setting...] beside [PLC name] and tick [system tag]. This allows users to use the preserved addresses by system for particular purpose.

These address tags are divided into bit or word (LB or LW).

After selecting [System tag] not only will the [Device type] displays the content of the chosen tag, [Address] will also display the register chosen as shown below.

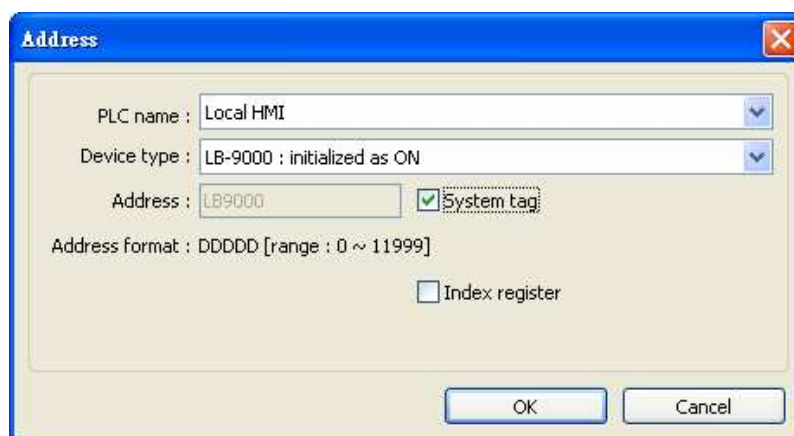

The illustration below shows a part of system tags. For further information, please refer “Chapter 16 Address Tag Library” and “Chapter 22 System Reserved Words and Bits”.

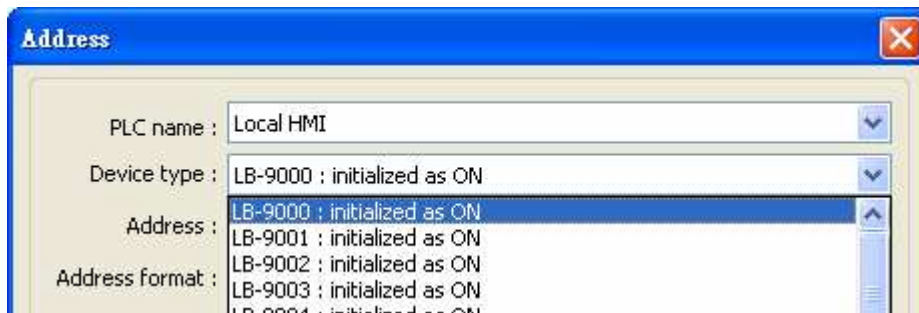

[Index register]

Deciding to use Index register or not, please refer to “Chapter 11 Index Register” for more information.

Selecting Data Type

EB 8000 supports data types that are listed below. Selecting correct data type is necessary especially while using address tag.

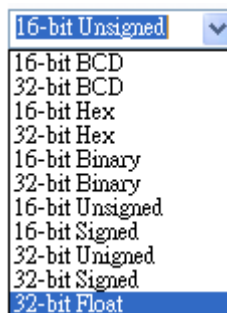

9.2 Using Shape Library and Picture Library

[Shape Library] and [Picture Library] are used for enhancing the visual effect of an object. For setting these, please go to **[Shape]** tab in the dialog for adding new object to set up [Shape Library] and [Picture Library].

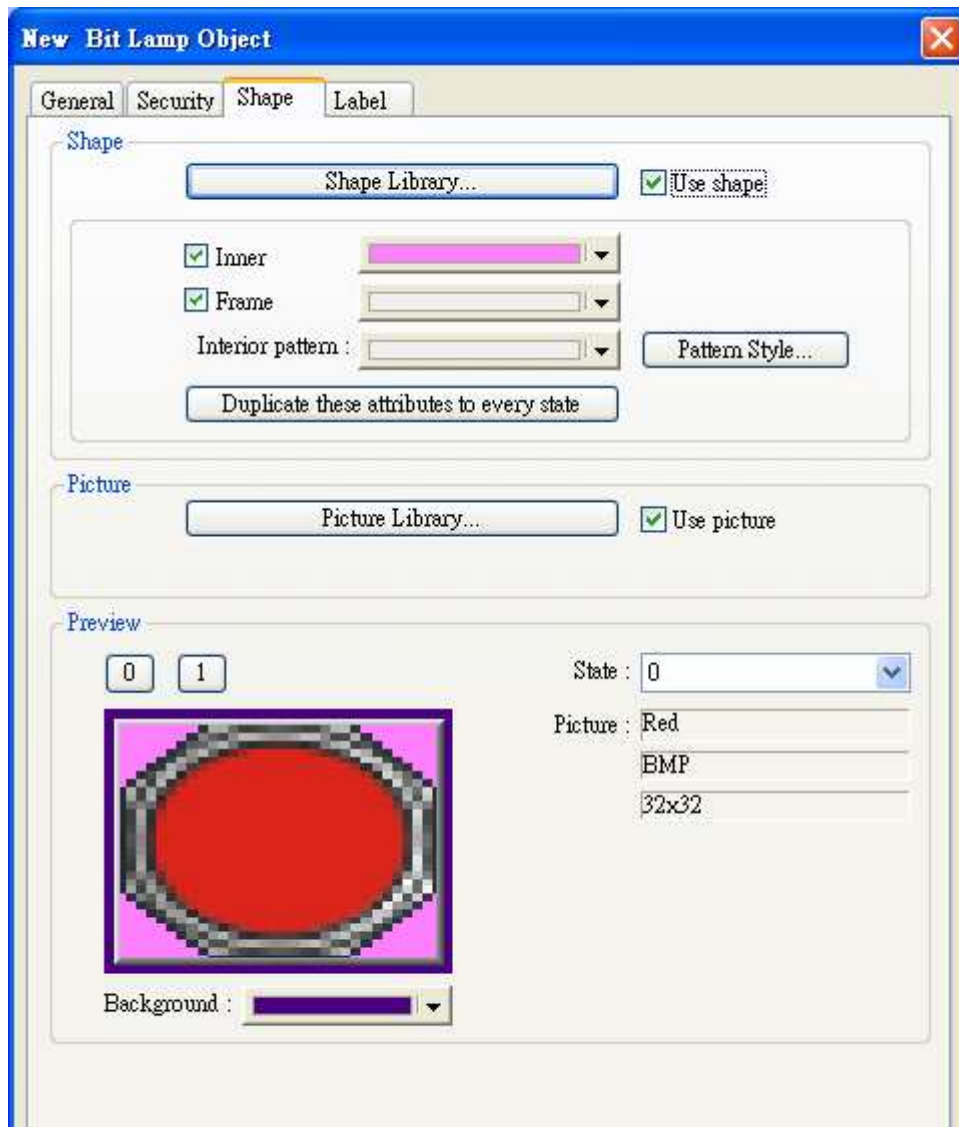

9.2.1 Settings of Shape Library

[Shape Library...]

Users can tick **[Use shape]** to enable this setting and select the shape from the library.

[Inner]

Tick [Inner] to enable this setting and select a color for inner part of the shape. Click drop down button to open the **[Color]** dialogue to choose a color from the list or **[customize]** their own color and click **[Add to Custom Colors]** for system to remember this color.

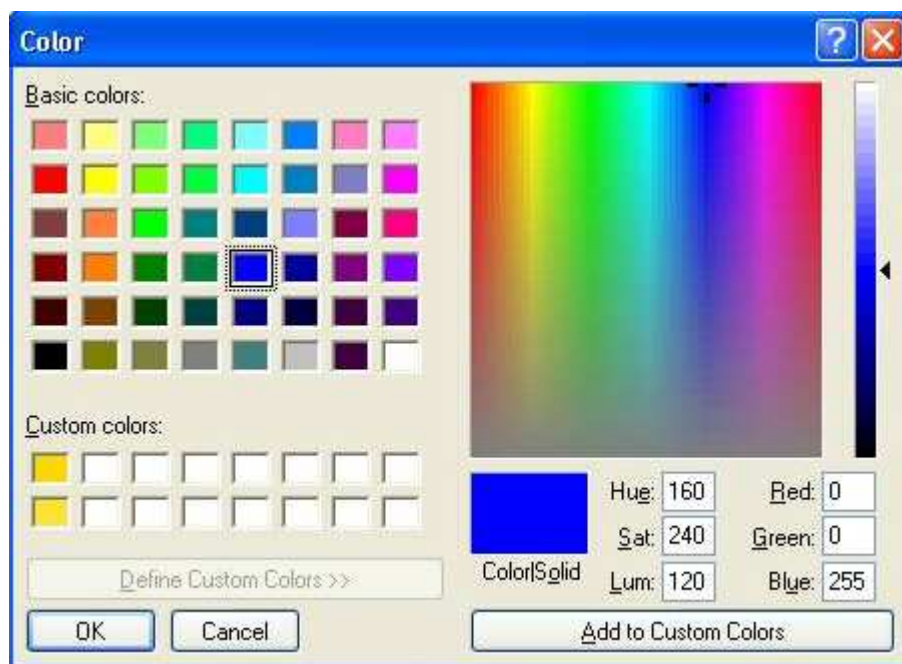

[Frame]

Tick [Frame] to enable this setting and select a **[color]** for the frame of the shape. The way of setting is same as above.

[Interior Pattern]

Click to select the style of the interior pattern of the shape. The color of this pattern can also be set.

[Pattern Style]

Click [Pattern Style] button to open the dialogue.

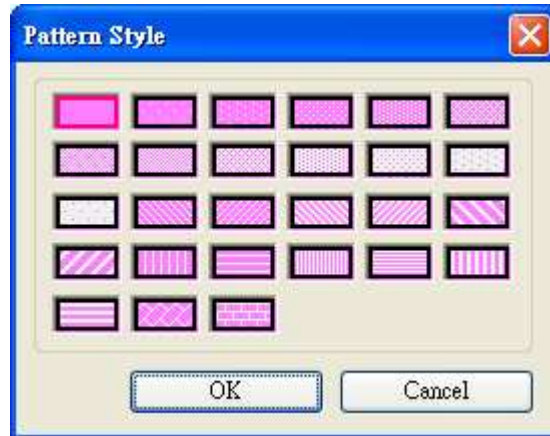

[Duplicate these attributes to every state]

Duplicate all attributes of the current state to other states.

How to set [Shape Library...]

Click [Shape Library...] button, the following dialog appears. The currently selected shape is marked by a red frame.

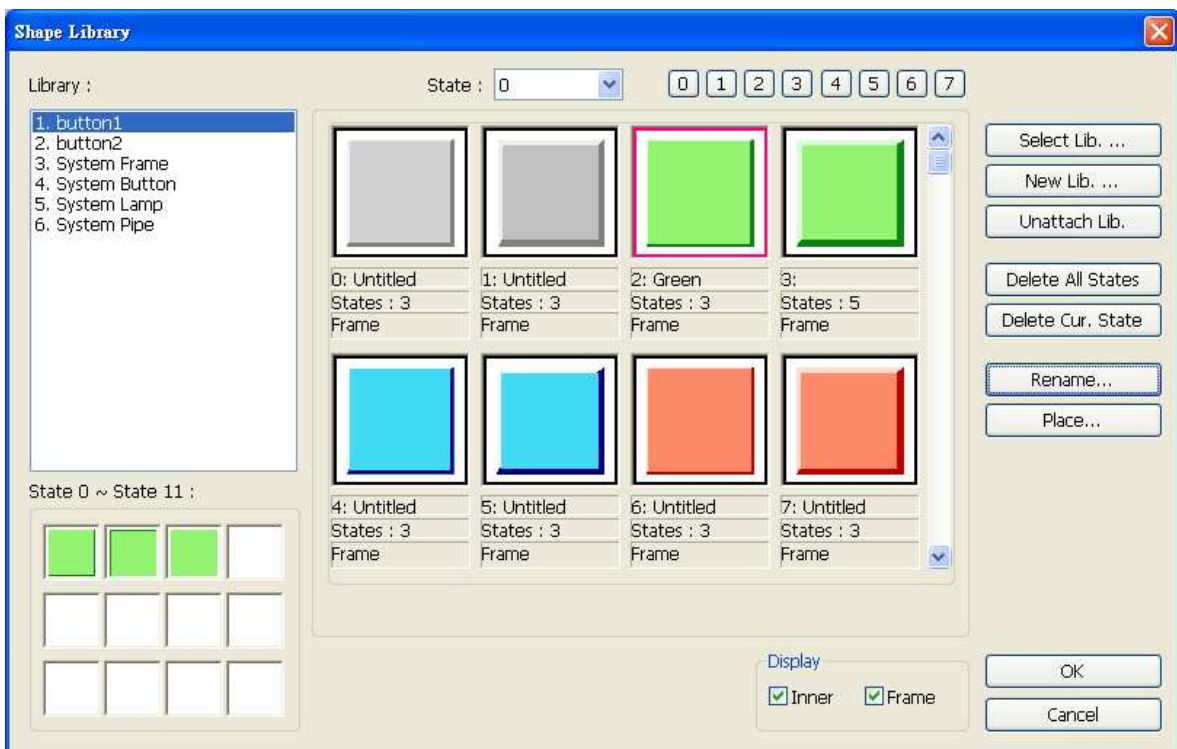



The illustration above provides information of one of the Shapes in the Shape Library as follows:

2: Green	The number and the name of the shape in the library.
States: 3	The number of the states of the shape. In this case, it shows the Shape possesses three states.
Frame	Indicates that the Shape is set with “frame” only.

The illustration below shows that the Shape is set with “inner” and “frame.”

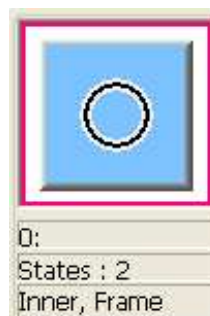

Note: About all the settings in **[Shape Library]**, please refer to the illustrations in “Chapter 14 Shape Library and Picture Library” for details.

Click **[OK]** and preview the design of the shape after the setting is completed.

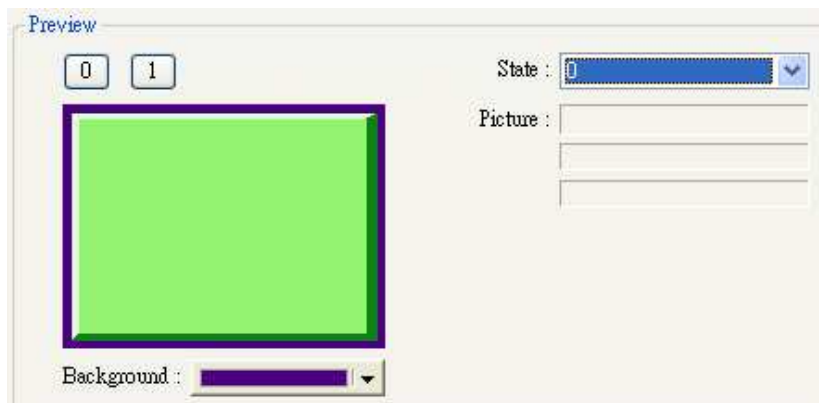

9.2.2 Settings of Picture Library

[Picture Library]

Users can click [Use picture] to enable selecting a picture from the library.

How to set [Picture Library...]

Click [Picture Library...] button and [Picture library] dialog appears. The currently selected picture is marked by a red frame.

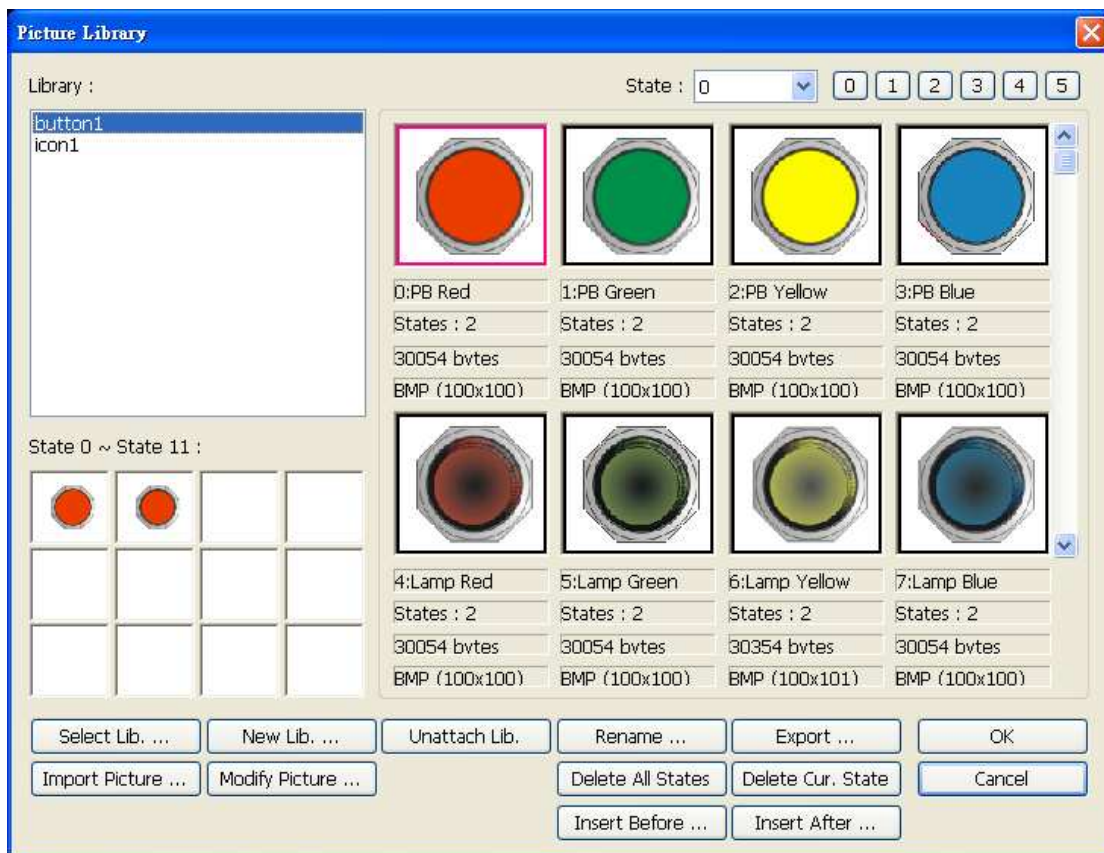

The illustration above provides information of one of the Pictures in the Picture Library as follows:

Picture name	0 : PB Red	The number and name of the Picture
Total states	2	The number of the states of the picture
Image size	30054 bytes	The size of the Picture
Image format	BMP (100x100)	The format and resolution of the Picture; BMP means bitmap Picture and its format can also be JPG, PNG, DPD, or GIF. Picture Length: 100 pixels and height: 100 pixels in this case.

Note: About all the settings in **[Picture Library]**, please refer to the illustrations in “Chapter 14 Shape Library and Picture Library” for details.

Click **[OK]** and preview the design of the picture after the setting is completed.

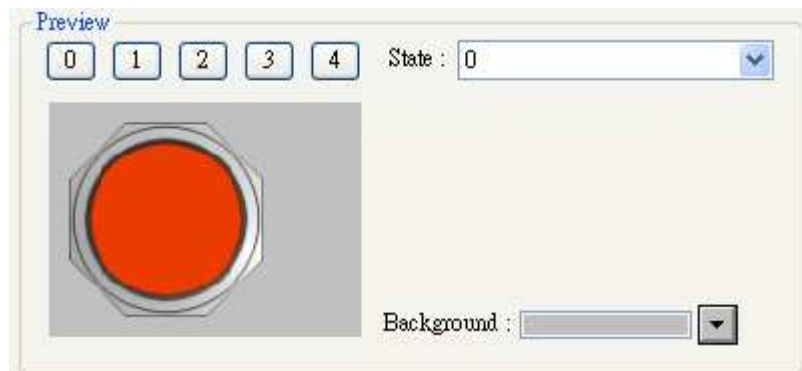

9.3 Setting Text Content

Go to **[Label]** tab while adding new object to set the text content as shown below.

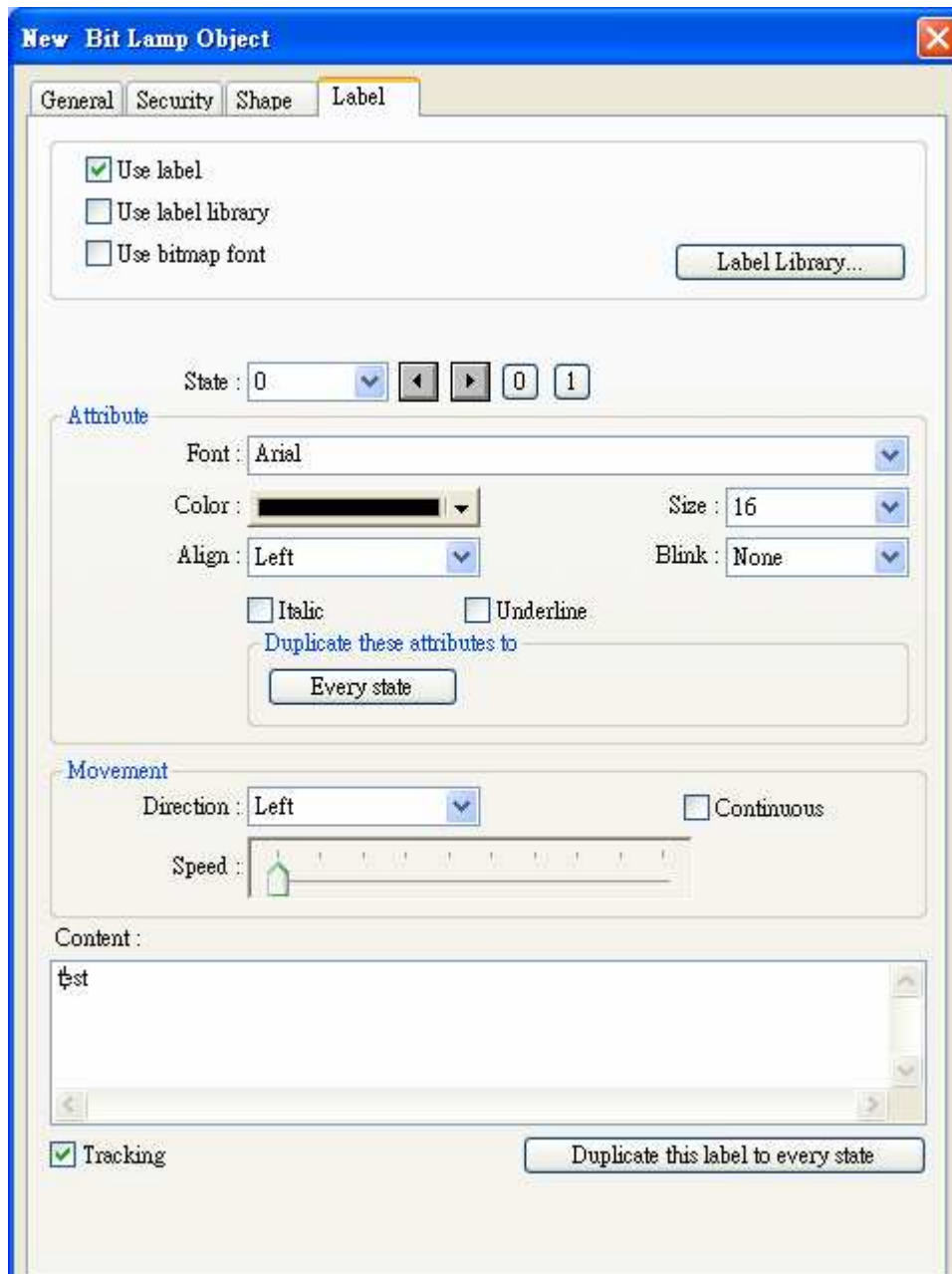

[Use label]

Check **[Use label]** and click **[Label Library]** button to add and edit the text. EB8000 supports Windows true-font.

[Use label library]

Check [Use label library] to choose a label tag that exists in Label Library as shown below.

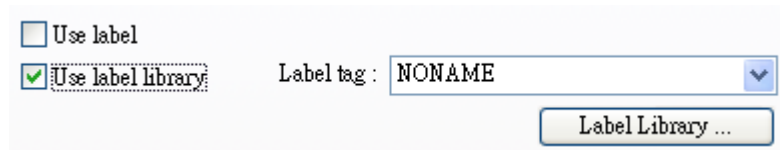
**[Label Library...]**

Note: About all the settings in **[Label Library]**, please refer to the illustrations in “Chapter 15 Label Library and use Multi-Language” for details.

[Font]

Select font style from font list. EB8000 supports Windows true-font as shown below.

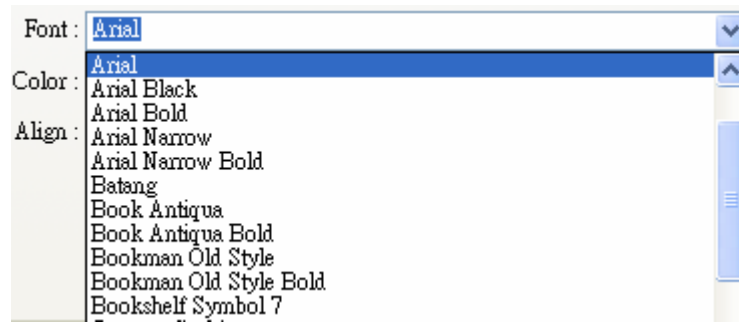
**[Color]**

Select the text color.

[Size]

Select the text size. The text sizes supported by EB8000 are listed below.

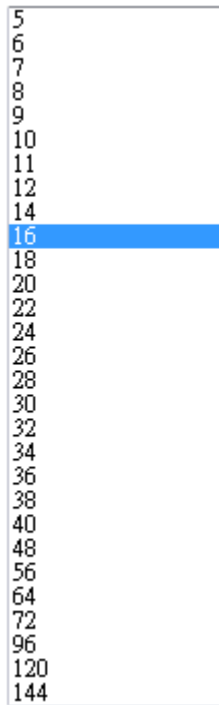

[Align]

Select how users would like to align the text in multiple lines

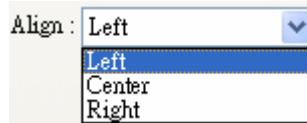

The text aligned **[Left]**.

111
222222
333333333

The text aligned **[Center]**.

111
222222
333333333

The text aligned **[Right]**.

111
222222
333333333

[Blink]

To decide how will the text blink:

Choose **[None]** to disable this feature or set blinking interval as **[1 second]** or **[0.5 seconds]**.



[Italic]

Use Italic font.

Italic Label

[Underline]

Use Underline font.

Underline Label

[Movement] setting

[Direction]

Set the direction of the marquee effect.

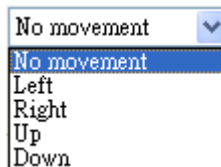

[Continuous]

Whether this selection is tick or not influences how the marquee effect is displayed:



If **not** checking [Continuous], the next text appears only when the previous text disappears completely. See the picture below.



If checking [Continuous], the text will be displayed continuously.



[Speed]

Adjust the speed of the text movement.

[Content]

Set the content of the text. If using **[Label Library]**, the content will be sourced from Label Library.

[Tracking]

When **[Tracking]** is selected, moving the text of one state will also move the text of other states.

[Duplicate this label to other states]

This function is used to duplicate the current text content to the other states.

9.4 Adjusting Profile Size

When an object is created, double click it and go to the [Profile] tab to adjust the position and size of the object.

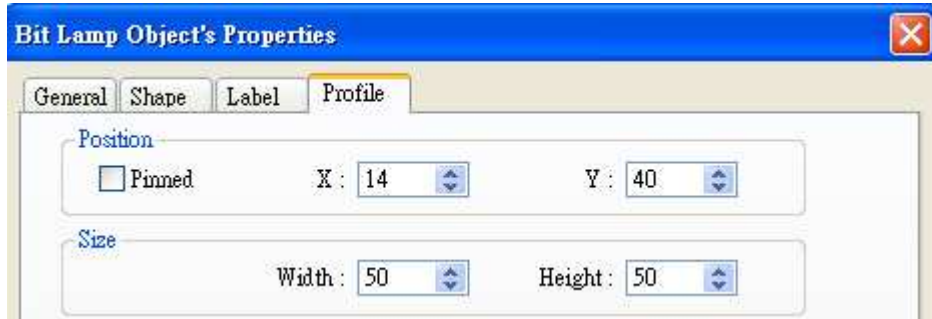

a. Position

Set if the position and size of the object is **[Pinned]**. When it is checked, the position and size of the object cannot be changed. X and Y mean the **[X]** and **[Y]** coordinate of the left-top corner of the object.

b. Size

Adjust the **[width]** and **[height]** of the object.

9.5 Variables of Station Number

EB8000 version 1.31 or higher allows users to set variables of station number in PLC address. As shown below, "var2" is one of 16 station number variables.

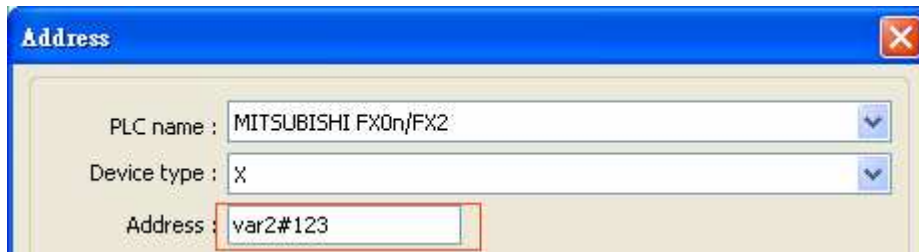

The syntax of variable of station number:

varN#address

The range of N is integer from 0~15; address means PLC address.

16 variables are available : var0 ~ var15. These variables of station number read values from address LW-10000~LW-10015. The list below shows variables and its corresponding system reserved address LW :

var0	LW-10000
var1	LW-10001
var2	LW-10002
var3	LW-10003
var4	LW-10004
var5	LW-10005
var6	LW-10006
var7	LW-10007
var8	LW-10008
var9	LW-10009
var10	LW-10010
var11	LW-10011
var12	LW-10012
var13	LW-10013
var14	LW-10014
var15	LW-10015

For example, “var0” reads value from LW-10000, when value in LW-10000 is “32”, var0#234 = 32#234 (the station number is 32); similarly, “var13” reads value from LW-10013, when value in LW10013 is” 5”, var13#234 = 5#234.

9.6 Broadcast Station Number

MT6000/8000 provides two ways for users to enable using broadcast command. First is to set it directly in **[system parameter settings] [Device]** tab:

PLC type : MITSUBISHI FX0n/FX2
V.1.00, MITSUBISHI_FX0N.so

PLC I/F : RS-485 4W PLC default station no. : 0

COM : COM1 (9600,E,7,1) Settings ...

Use broadcast command Broadcast station no. : 0

Second way is to use system tag to enable or disable broadcast station number or to change it.

Corresponding system tags are listed as below:

LB-9065	disable/enable COM 1 broadcast station no.
LB-9066	disable/enable COM 2 broadcast station no.
LB-9067	disable/enable COM 3 broadcast station no.
LW-9565	COM 1 broadcast station no.
LW-9566	COM 2 broadcast station no.
LW-9567	COM 3 broadcast station no.

Chapter 10 Security

Object Security in EasyBuilder Pro includes:

1. User password and corresponding operable object classes.
2. Security settings of each object.



10.1 User Password and Operable Object Classes

[System Parameter Settings] / [Security]:

Password should be digits from **0 to 9** and up to **12** sets of user password are available. There are seven security levels, classified from **A to F** and includes **none**.

Once password is entered, the objects that the user can operate are set here. For example below, the security class of “User 1” can only operate objects with classes “A, C, E” and “none”.

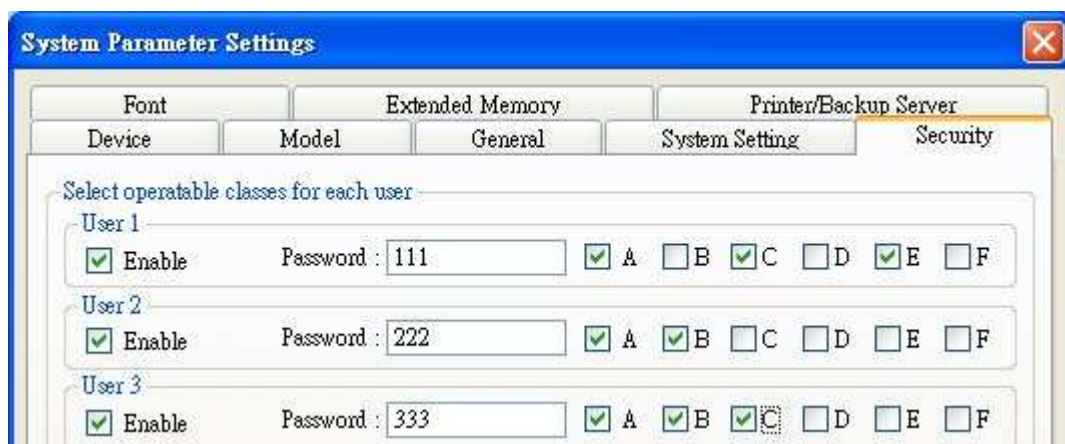

10.2 Object Security Settings

[Safety control]

To prevent miss-operation.

[Min. press time (sec)]

Continuously press the object longer than the time set here to activate the object.



[Display confirmation request] After pressing the object, a dialog appears for operation confirmation. If response to this dialog comes later than the set **[Max. waiting time (sec)]**, this dialog disappears automatically and the operation will be canceled.

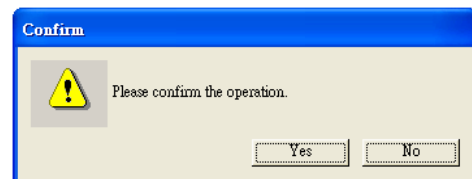

[Interlock]

When ticked, whether this object can be operated depends on the state of the specified Bit address. As shown, if LB-0 is ON, the object can be operated.

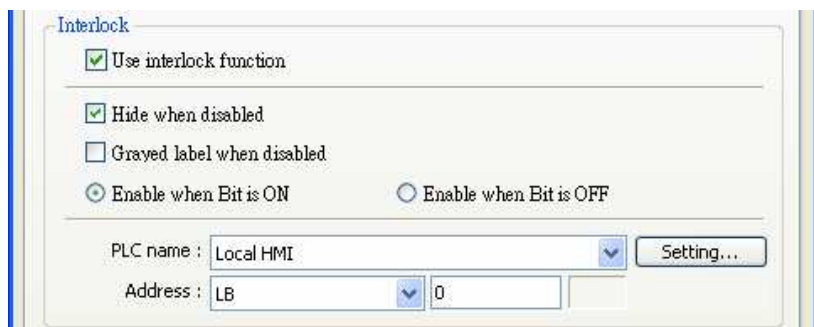

[Hide when disabled] When the specified Bit is OFF, hide the object.

[Grayed label when disabled] When the specified Bit is OFF, the label of the object turns gray.

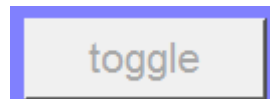

[User restriction]

Only when user's permitted class matches the object's can it be operated.



[Object class] "none"

means any user can operate this object.

[Disable protection permanently after initial activation] Once the permitted class of the user matches that of the object, the system will stop checking the security class permanently; even a different user can operate freely.

[Display warning message if access denied] When the classes of user and object do not match, a warning dialog (Window 7) appears. The content of the message can be modified.

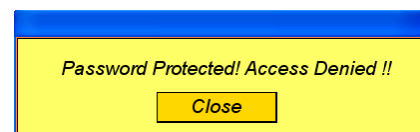

[Make invisible while protected] When the classes of user and object do not match, hide the object.

10.3 Setting Example

Example 1

1. Create a project, go to **[System Parameter Settings] / [Security]** to enable 3 users:

User 1 =

Operable class: A

User 2 =

Operable class: A, B

User 3 =

Operable class: A, B, C

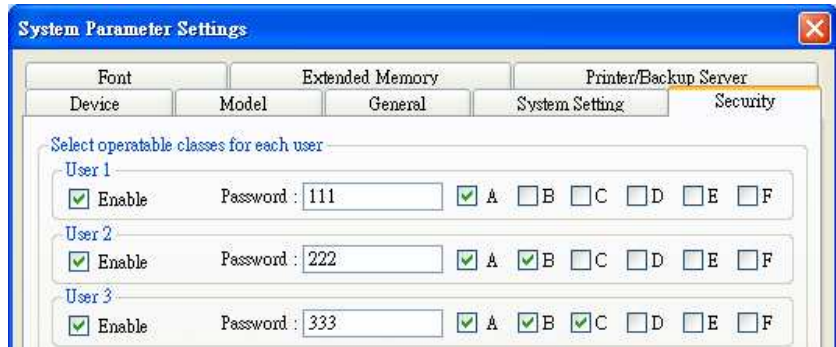

2. Design Window 10:

[Numeric Input] object

[LW-9219] user no. (1~12)

Length = 1 word

(16-bit Unsigned)

[LW-9220] password

Length = 2 words

(32-bit Unsigned)

[Numeric Display] object

[LW-9222] current user

operable classes

(16-bit Binary)

[Set Bit] object

[LB-9050] user logout

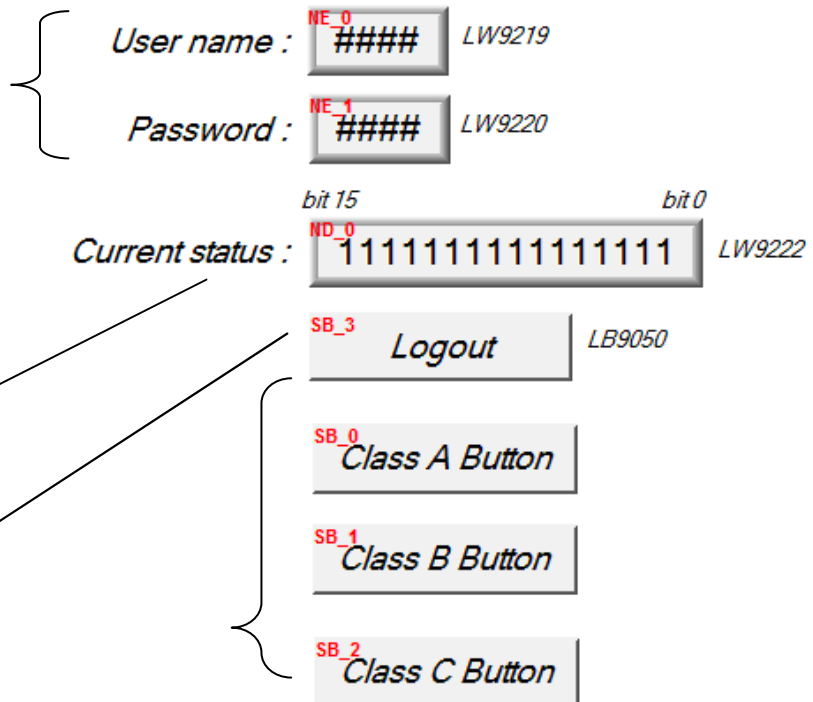

Three **[Set Bit]** objects, each

set to different classes but all select **[Made invisible while protected]**.

After designing and setting the objects, please save, compile the project and do off-line simulation. Below shows how it works when simulating.

3. When no password is entered yet, it displays "00000000000000", meaning user operable object class "none". [SB_0] ~ [SB_2] objects are classified "A" ~ "C" and selected **[Made invisible while protected]**, therefore they are hidden at this moment.

User name : LW9219

Password : LW9220

Current status : LW9222

LB9050

4. Input User 1 password "111".

Since User 1 is only allowed to operate class A objects, [SB_0] object will appear for operating. [LW-9222] bit 0 turns "1", meaning user operable class: A.

User name : LW9219

Password : LW9220

Current status : LW9222

LB9050

5. Input User 3 password "333". Since User 3 is allowed to operate class A, B, C objects, [LW-9222] bit 0 ~bit 2 turns "1", meaning user operable class: A ~ C.

User name : LW9219

Password : LW9220

Current status : LW9222

LB9050

6. Click [LB9050] user logout, the system will return to initial state, current user can only operate class "none" objects.

User name : LW9219

Password : LW9220

Current status : LW9222

LB9050



- **Password input** If the password is incorrect, [LB-9060] will be set to ON; if the password is correct, [LB-9060] will return OFF.

User 1~12 password can be read from system registers [LW-9500] ~ [LW- 9522], 24 words in total.

- **Change password when HMI is in operation** When [LB-9061] turns from OFF to ON, data in [LW-9500] ~ [LW-9522] can be used to update user password, and use the new password in the future. The user operable object classes will not change due to the change of password.
-

Chapter 11 Index Register

11.1 Introduction

EasyBuilder Pro provides 32 Index Registers for users to change addresses flexibly. With Index Register, users can update object's read/write address without changing its content while HMI is running the project.



There are 32 Index Registers listed below:

16-bit Index Register:

Index 0 [LW-9200] (16-bit)~

Index 15 [LW-9215] (16-bit)

Max. range: 65536 words

32-bit Index Register:

Index 16 [LW-9230] (32-bit)~

Index 31 [LW-9260] (32-bit)

Max. range: 4294967296

words

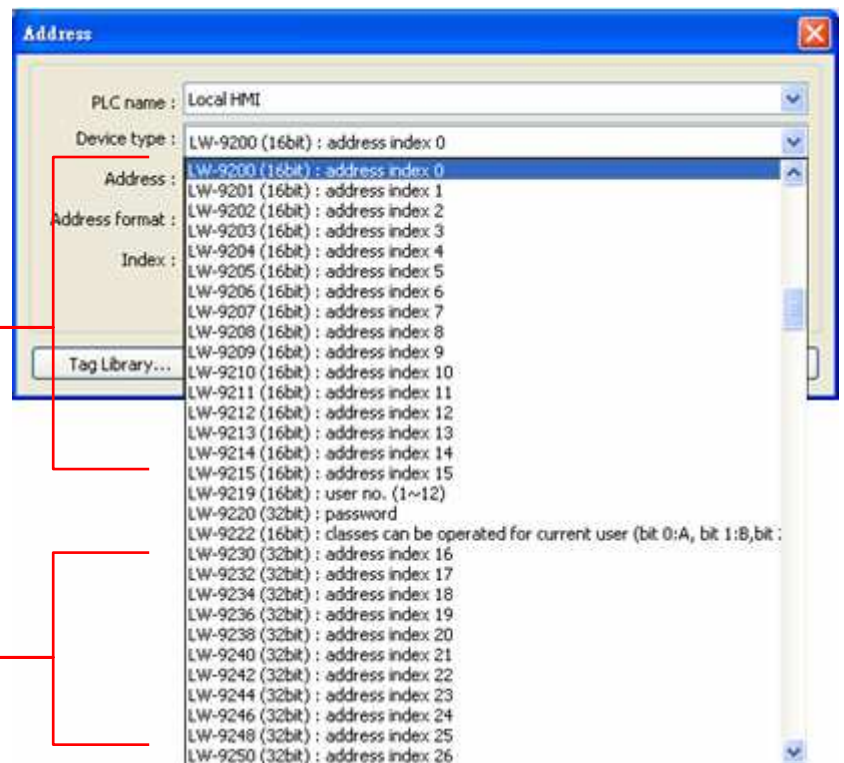

Index 0 ~ Index 31: Descriptions of Index Registers.

[LW-9200] ~ [LW-9260]: Index Registers word addresses.

While using [**Index register**], the address of the [**Device type**] will be decided by the value of “constant in set address + value in chosen Index Register”.



Index Register works in all [**Device lists**] built in [**System Parameter Settings**], no matter addresses in bit or word format.

11.2 Examples of Index Register

The following examples show how to use Index Registers.

[Index register] not checked:
Read address is set to [LW-10]
and won't change while
running project.

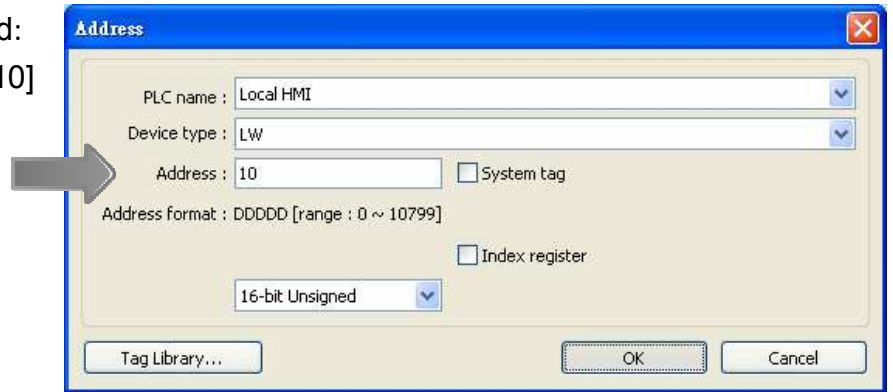

[Index register] is checked
and index register **[INDEX 0]** is
selected: read address is set to
[LW-0 + INDEX 0]
INDEX 0: Index Register 0
or data of address
[LW-9200].
If data of address [LW-9200] is
"5", read address is set to
[LW(0+5)] = [LW-5].

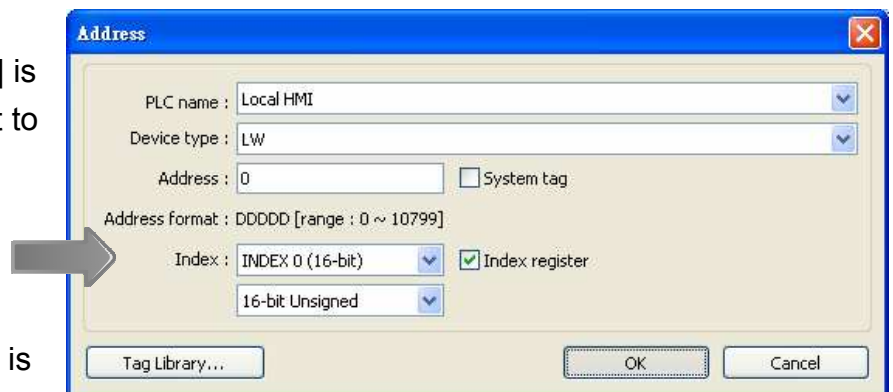

Here's a demo project shown as an example:

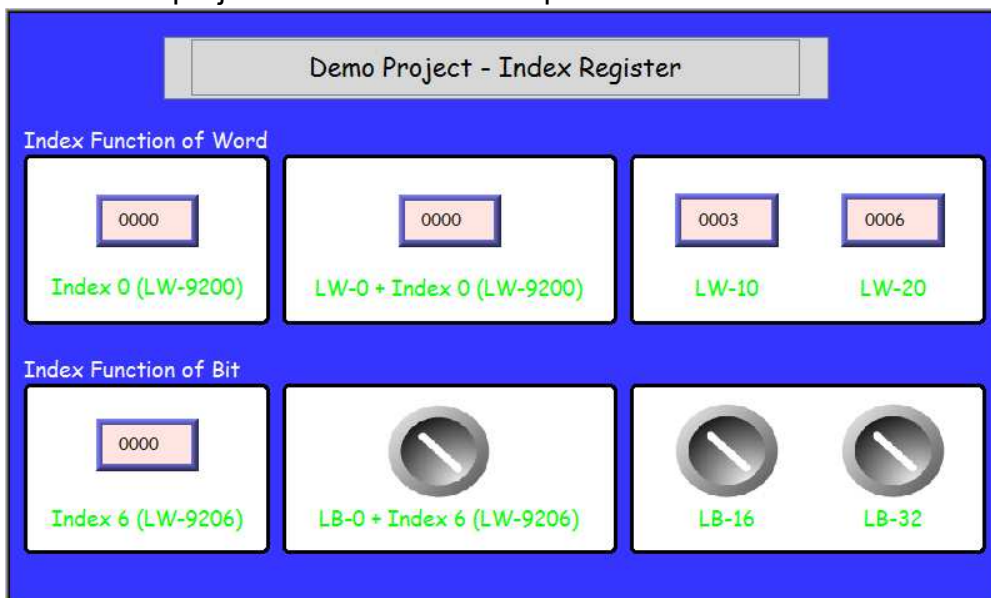

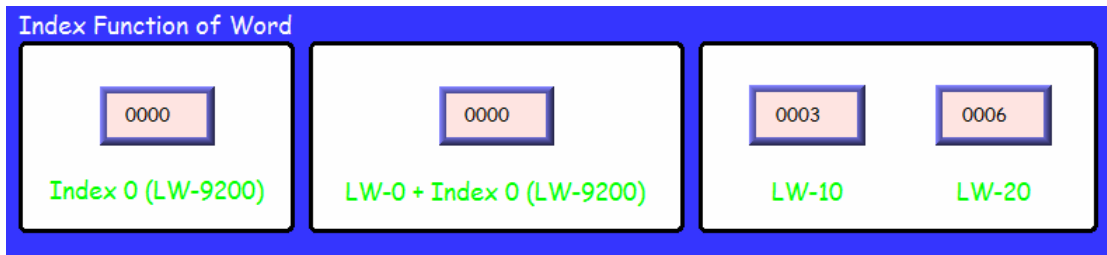
Example 1 Index Function of Word

Index 0 is "0"
= data in address
[LW-9200] = "0"

Read [LW-0 + Index 0]
= Read [LW-0] content

[LW-10] is set to
"3" [LW-20] is set
to "6"

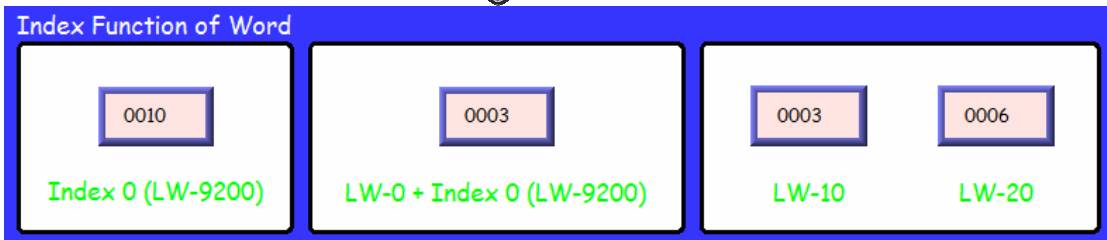

Index 0 [LW-9200]
is set to "10"

Read [LW-0 + Index 0]
= Read [LW-10] = "3"

Example 2 Index Function of Bit

In the same way, Index Register can be used for Bit address.

1 Word = 16 Bit, adding 1 Word in value of index register = adding 16 Bits



Index 6 [LW-9206]
is set to "1"

The switch [LB-0 + Index 6] reads LB-16 address = ON



Index 6 is set to "2" The switch [LB-0 + Index 6] reads LB-32 address = OFF



Conclusion: Index Register is used to change addresses. Through changing the data in Index Register, we can make an object to read and write different addresses without changing its own address of the device. Therefore we can transmit or exchange data among different addresses.



Please confirm your internet connection before downloading the demo project.

Chapter 12 Keyboard Design and Usage

 “Numeric Input” and  “ASCII Input” objects need to use keyboard as input tool.

Both numeric keyboard and ASCII keyboard are created with  “Function Key” object. The types of keyboards are:

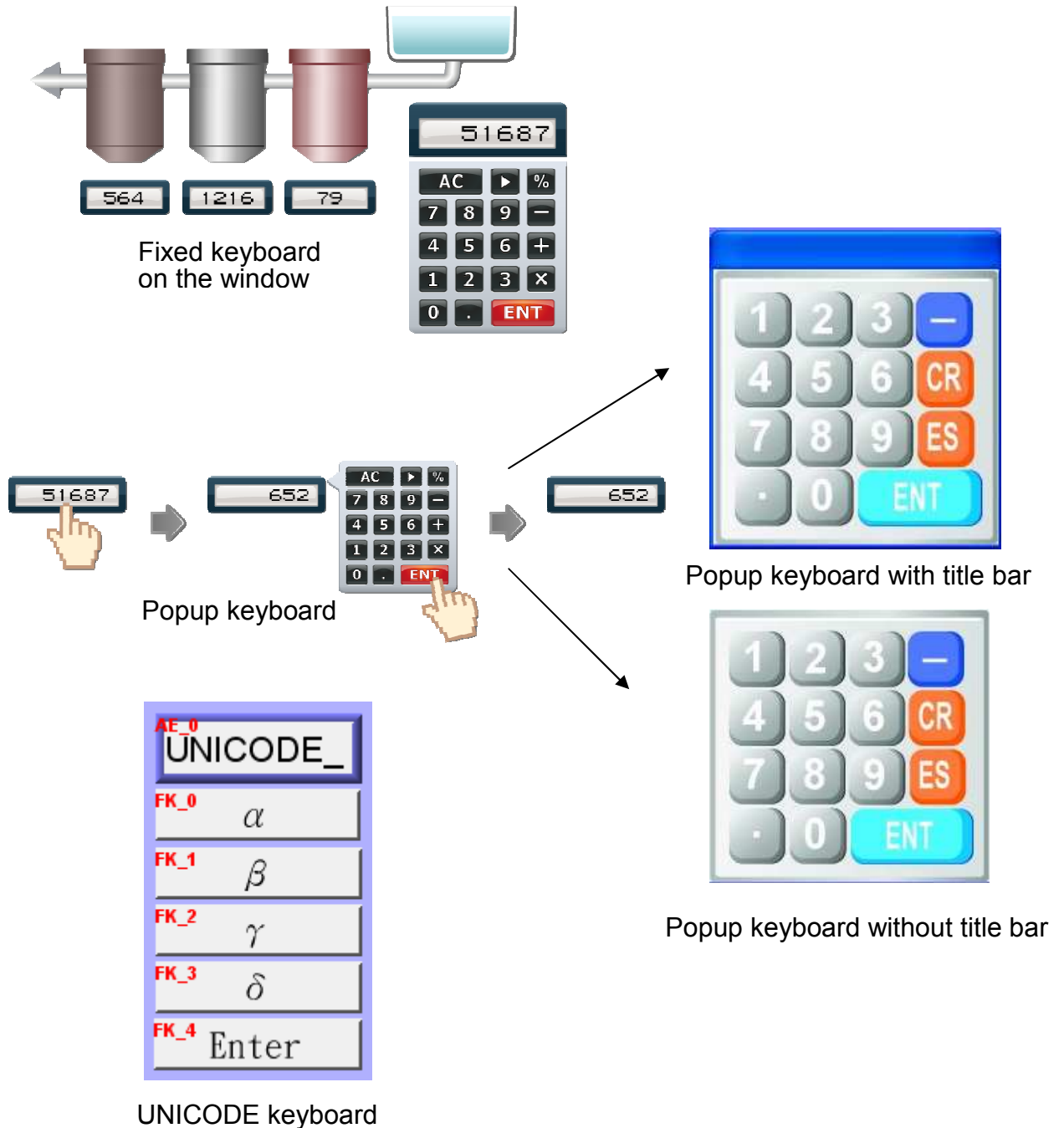

12.1 Steps to Design a Pop-up Keyboard

Step 1 Create and open a window for a keyboard to be added. For example, set to “WINDOW 200”.

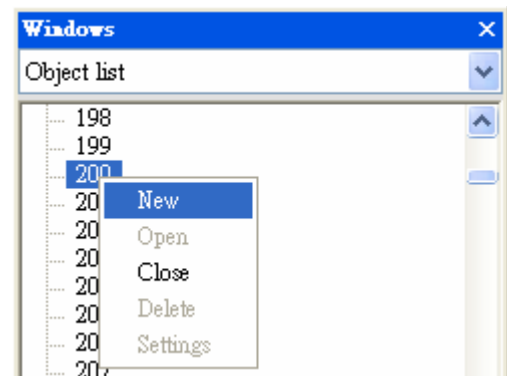

Step 2 Adjust the height and width of “WINDOW 200” and create a variety of “Function Key” objects in **[ASCII/UNICODE mode]**.

For example:

[FK_11] is used as the **[Esc]** key.

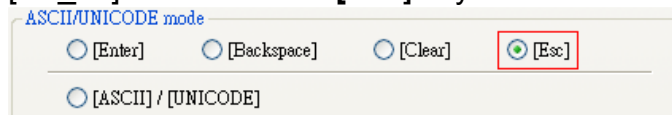

[FK_14] is used as the **[Enter]** key.

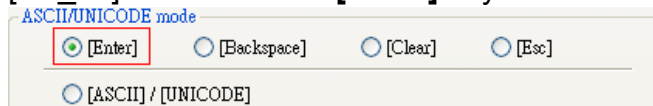

The rest are mostly used to input number or text. For example, [FK_0] is used for inputting number “1”.

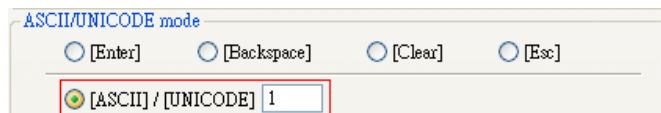

Step 3 Select a suitable picture for each “Function Key” object. [GP_0] is a picture object which is placed at the bottom layer as the background.

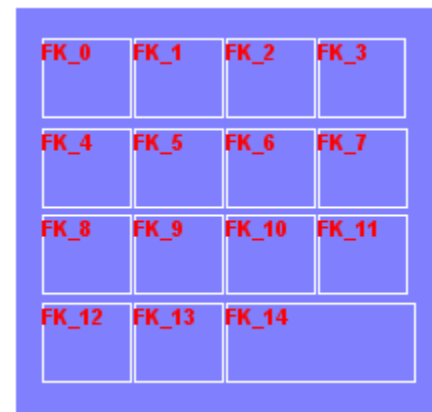

Step 4 Select **[System Parameter Settings] / [General] / [Keyboard] / [Add] [Window 200]**. Up to 32 keyboard windows can be added.

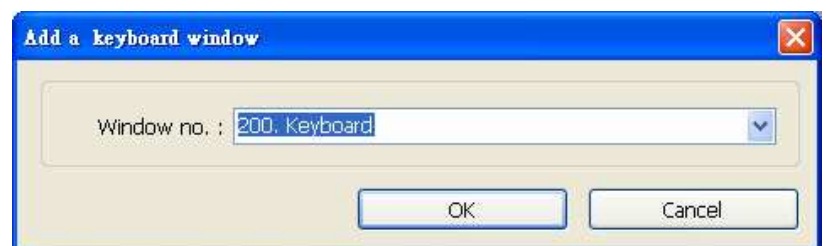

Step 5 After the keyboard window is added, when creating “Numerical Input” and “ASCII Input” objects, “200 Keyboard” can be found in **[Data Entry] / [Keyboard] / [Window no.]**.

The **[Popup position]** is used to decide the display position of the keyboard on screen. The system divides the screen into 9 areas.

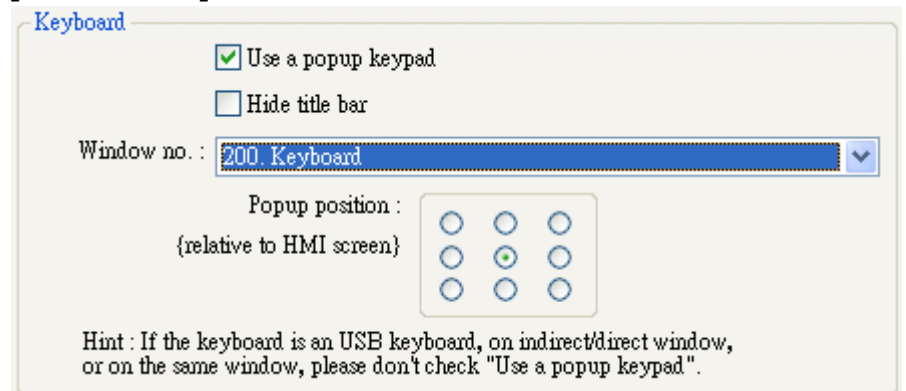

Step 6 Select “200.Keyboard”.
When users press “Numerical Input” or “ASCII Input” objects, WINDOW 200 will pop up on HMI screen. Users can press keys on keyboard to input data.

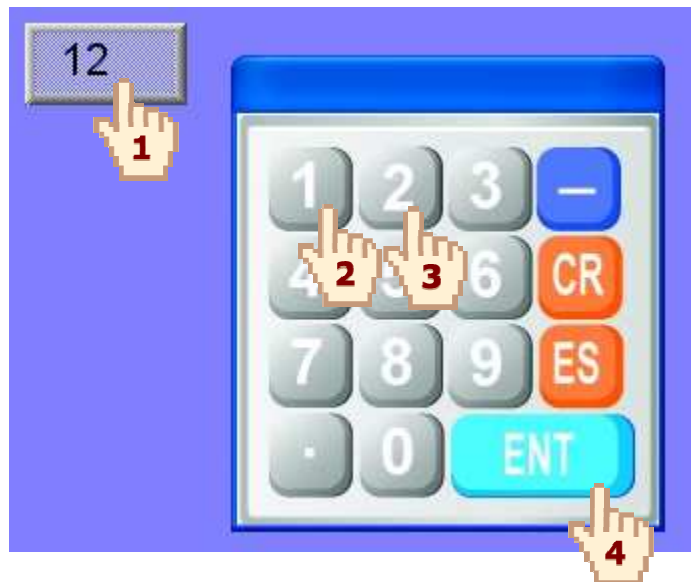

12.2 Steps to Design a Keyboard with Direct Window

Step 1 Create a  "Direct Window" and set a read address to activate it. In **[General]/[Attribute]** select **[No title bar]** and correct **[Window No.]**.

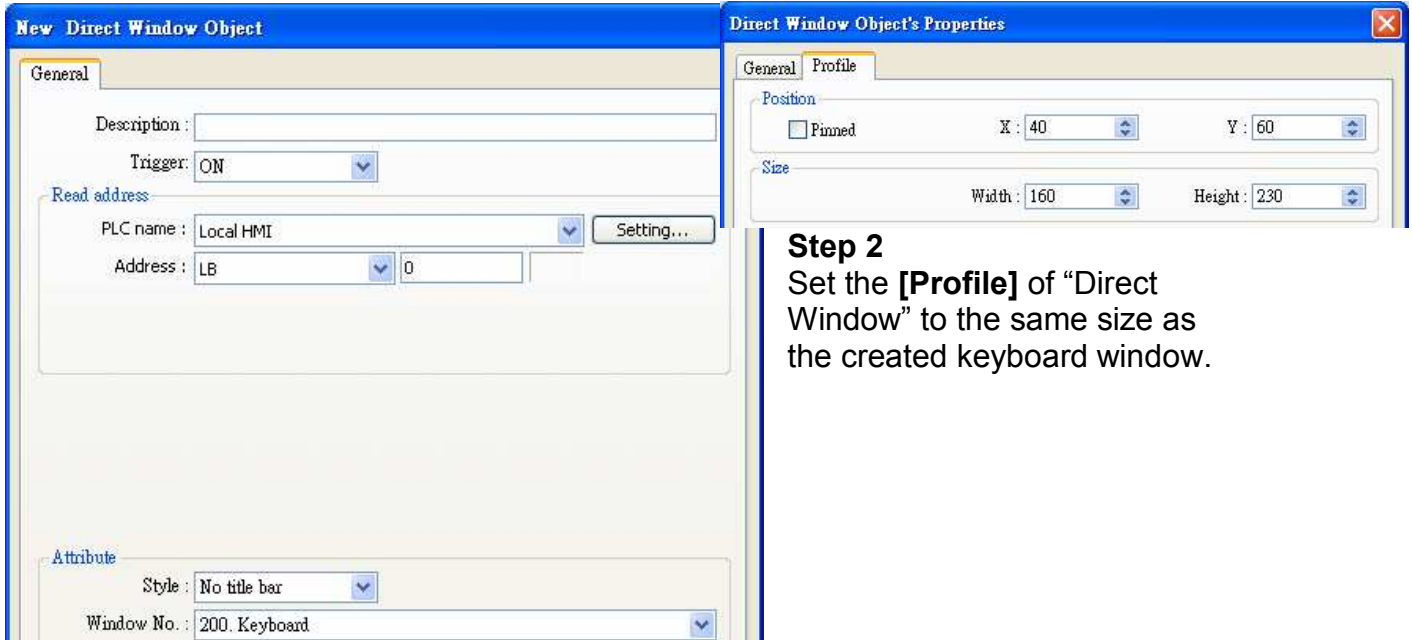

Step 2
Set the **[Profile]** of "Direct Window" to the same size as the created keyboard window.

Step 3 Create a  "Numeric Input" object, and **don't** tick **[Use a popup keypad]**.

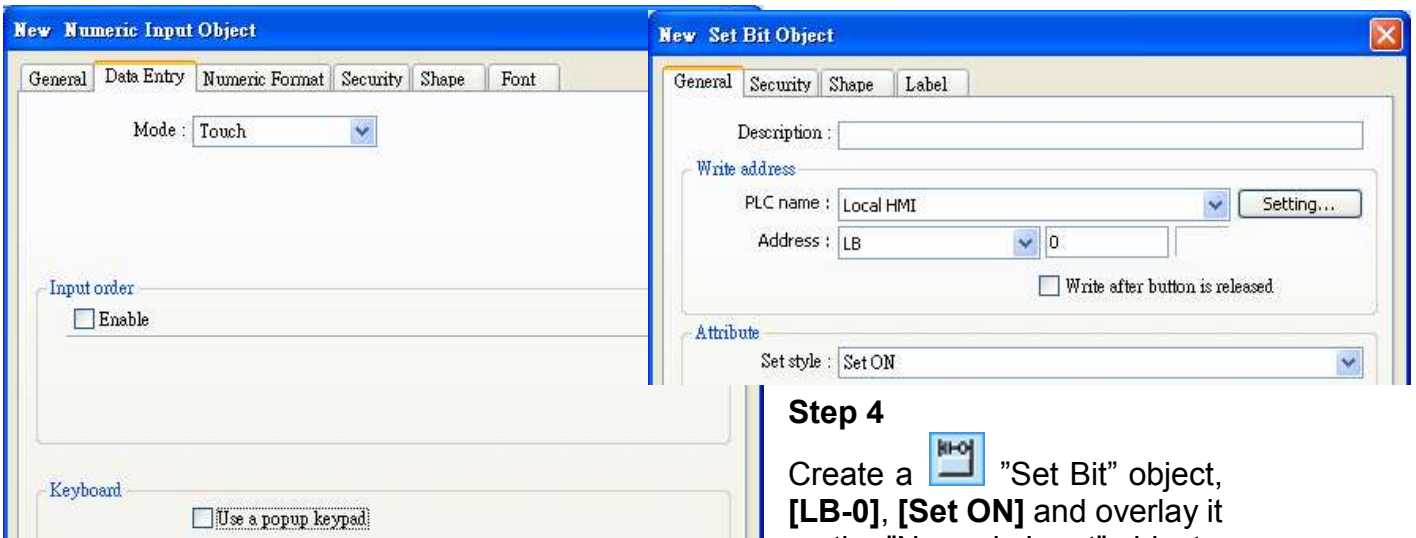

Step 4
Create a  "Set Bit" object, **[LB-0]**, **[Set ON]** and overlay it on the "Numeric Input" object.

Step 5 Add "Set Bit" objects on **[Enter]** and **[ESC]** function keys respectively. **[LB-0]**, **[Set OFF]**, in this way when users press either **[Enter]** or **[ESC]** will close the keyboard.

12.3 Steps to Design a Fixed Keyboard on Screen

Users can also place a fixed keyboard on the window instead of popup keyboard or direct window. The keyboard can't be moved or canceled this way.

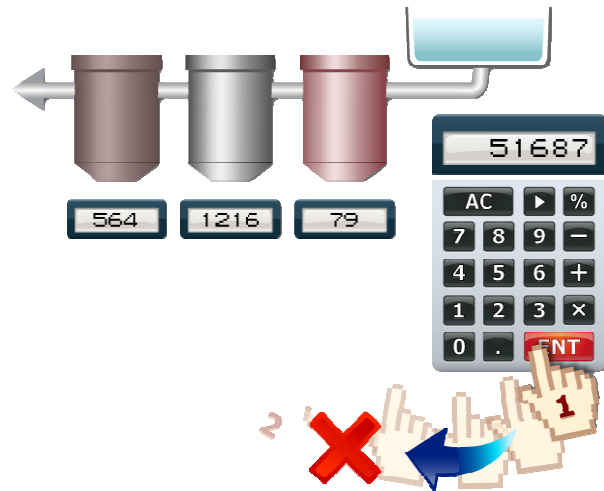

Step 1

Create a  "Numeric Input" object, in [Data Entry] / [Keyboard] don't tick [Use a popup keypad].

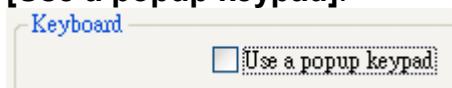

Step 2

Use  "Function Keys" to design the keyboard and place them on screen.

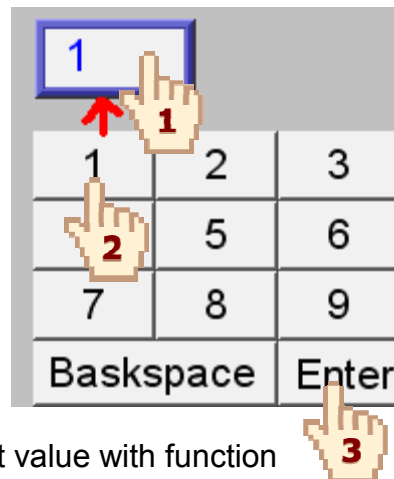

Step 3

Press "Numeric Input" object, users can input value with function keys directly.

12.4 Steps to Design a UNICODE Keyboard

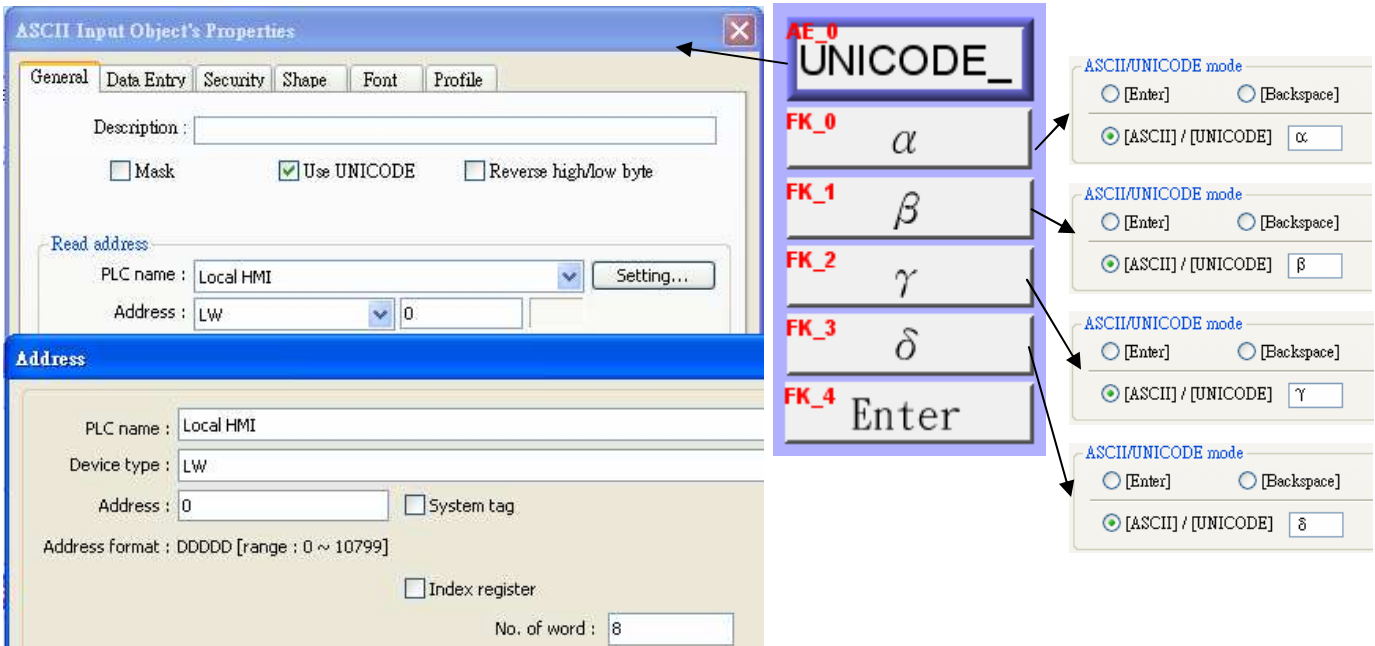

Place an  "ASCII Input" object on screen, tick **[Use UNICODE]**.

Create  "Function Keys" **[α]** **[β]** **[γ]** **[δ]** as shown, and an **[Enter]** key, a simple UNICODE keyboard is built.



Users can "Group" the self defined keyboard and "Save to Group Library" for future use.

Chapter 13 Objects

This chapter is to illustrate the ways of using and setting all kinds of objects. For those settings general for all the objects, such as index register, label, shape, and so on, please refer to “Chapter 9 Object’s General Properties”.

13.1 Bit Lamp

Overview

Bit Lamp object displays the ON and OFF state of a bit address. If the bit state is OFF, the State 0 shape will be displayed. If the bit state is ON, the State 1 shape will be displayed.



Configuration

Click the **[Bit Lamp]** icon in the toolbar and the **[Bit Lamp Object’s Properties]** dialogue box will appear, fill in the content of and press **[OK]**, a new bit lamp object will be created. See the pictures below.

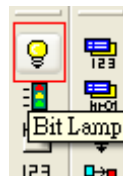



New Bit Lamp Object

General Security Shape Label

Description :

Read address

PLC name : Local HMI

Address : LB

Invert signal

Blinking

Blinking time : 0.5 second(s)

Mode : Alternating image on state 0

OK Cancel Help

Setting	Description
Description	A reference name that's assigned by user for the object. The system does not make use of this reference name since it is for user's document only.

<p>Read address</p>	<p>Click [Setting...] to select the [PLC name], [Address], [Device type], [System tag], [Index register] of the bit device that controls the bit lamp object. Users can also set address in [General] tab while adding a new object.</p> 
	<p>[Invert signal] Display shape with inverse state; for example, the present state is “OFF”, but it displays the shape of “ON” state.</p>
<p>Blinking</p>	<p>Set blinking attribute of bit lamp.</p>
	<p>[Blinking mode]</p> <p>a. None No blinking.</p> <p>b. Alternating image on state 0 Alternatively display the shape of state 0 and state 1 when the bit value is OFF (state 0).</p> <p>c. Alternating image on state 1 Alternatively display the shape of state 0 and state 1 when the bit value is ON (state 1).</p> <p>d. Blinking on state 0 Display the shape of state 0 in blinking when the bit value is OFF (state 0).</p> <p>e. Blinking on state 1 Display the shape of state 1 in blinking when the bit value is ON (state 1).</p>

13.2 Word Lamp

Overview

A Word Lamp object displays the corresponding shape according to the value in the designated word address. (up to maximum of 256 states)

Numeric Display (LW0) Word Lamp (LW0)

0

State 0

Numeric Display (LW0) Word Lamp (LW0)

1

State 1

Numeric Display (LW0) Word Lamp (LW0)

2

State 2

Configuration

Click the **[Word Lamp]** icon in the toolbar and the **[Word Lamp Object's Properties]** dialogue box will appear, fill in each items and press **[OK]** button, a new word lamp object will be created. See the pictures below.

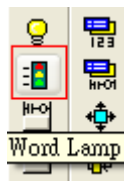

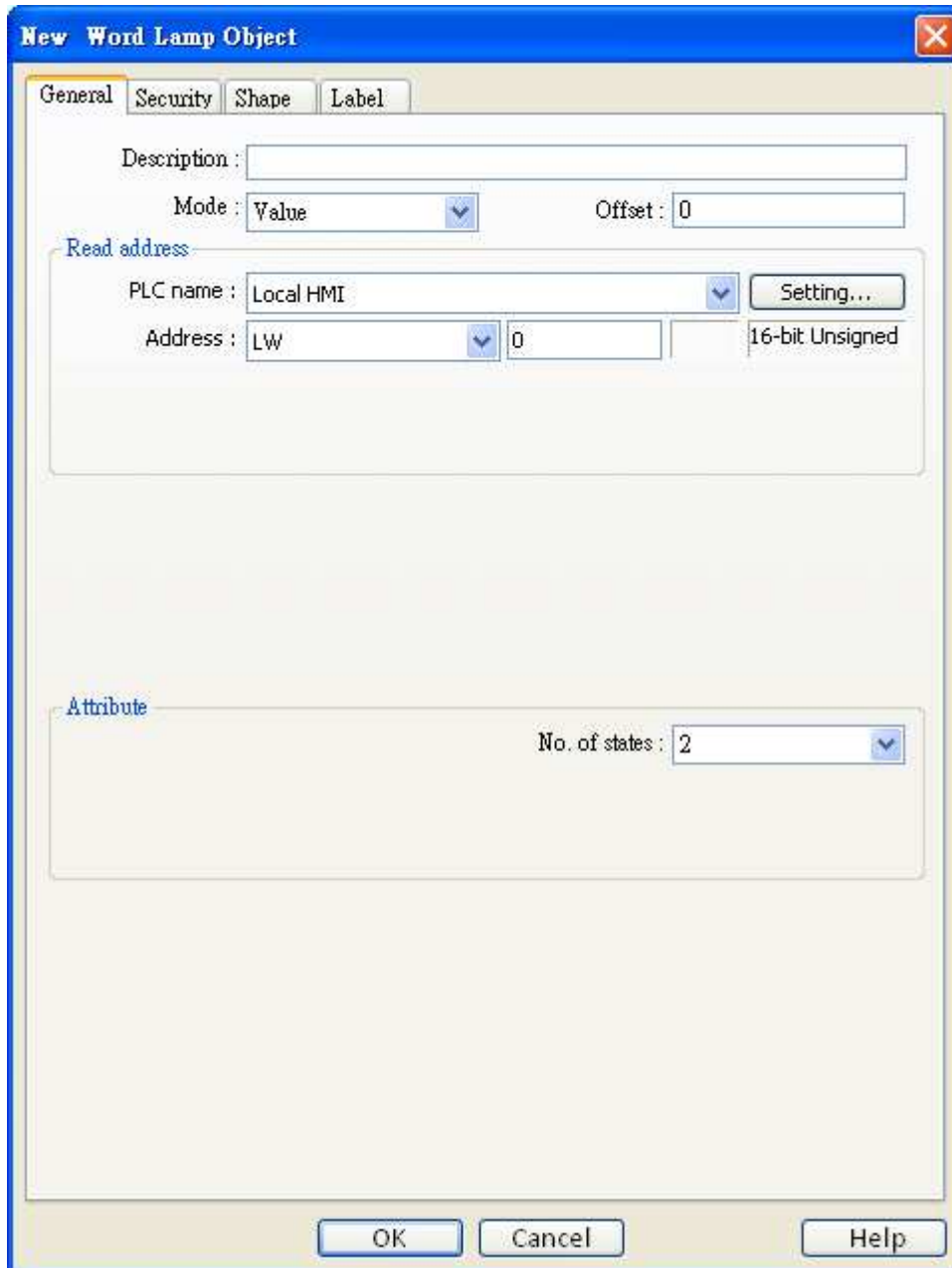

Setting	Description
[Mode] / [Offset]	<p>Word lamp object offers the following three modes for selection:</p> <p>a. Value Calculate result of word value to subtract [Offset] and display its corresponding shape.</p>

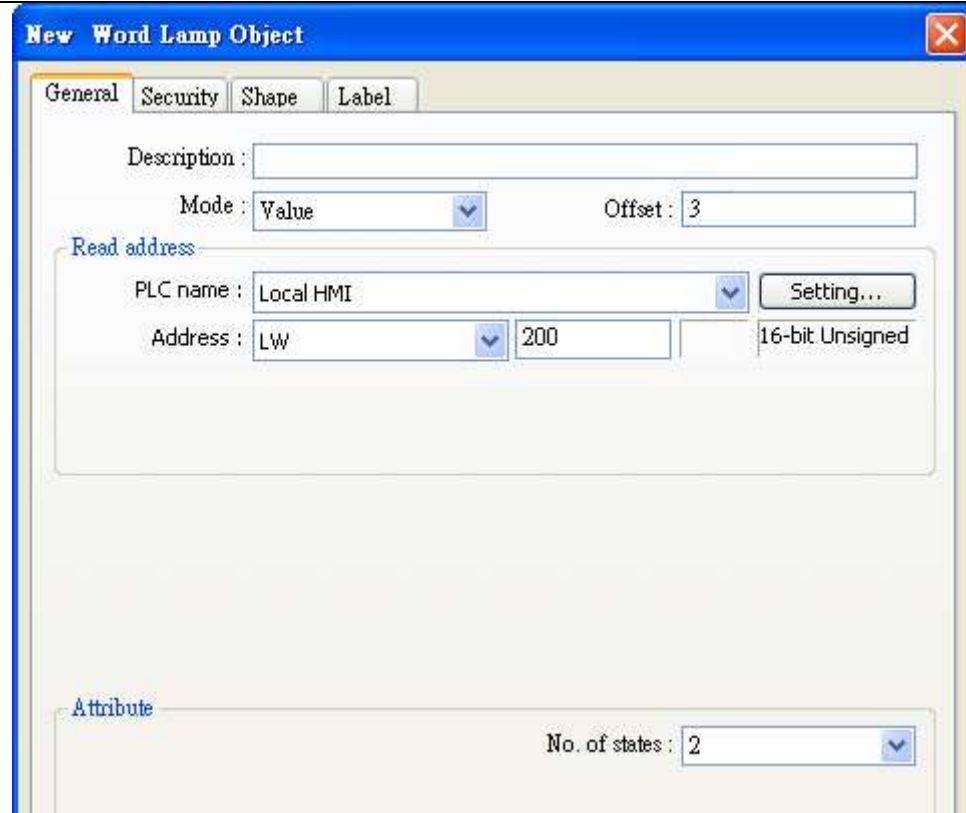

New Word Lamp Object

General Security Shape Label

Description :

Mode : Value Offset : 3

Read address

PLC name : Local HMI

Address : LW 200 16-bit Unsigned

Attribute

No. of states : 2

In the above setting, if the value of [LW200] is “5”, the shape of state “2” is displayed. See the picture below.

5

LW200

State 2

LW200, Offset = 3

b. LSB

Transfer the read address value to binary, the lowest 8 bits other than value 0 decides the state. Please refer to the following table.

Read address value	Binary value	Displayed state
0	0000	All bits are 0, display the shape of state 0
1	0001	The lowest bit other than 0 is bit 0, display the shape of state 1
2	0010	The lowest bit other than 0 is bit 1, display the shape of state 2
3	0011	The lowest bit other than 0 is bit 0, display the shape of state 1
4	0100	The lowest bit other than 0 is bit 2, display the shape of state 3
7	0111	The lowest bit other than 0 is bit 0, display the shape of state 1
8	1000	The lowest bit other than 0 is bit 3, display the shape of state 4

c. Change state by time

The states of the object have nothing to do with the word value. The system displays different shape of states according to time frequency.

Read address

Click **[Setting...]** to Select the **[PLC name]**, **[Device type]**, **[Address]**, **[System tag]**, **[Index register]** of the word device that controls the word lamp object. Users can also set address in **[General]** tab while adding a new object.



Attribute

[No. of states]

The number states one object possesses. State 0 is also counted as one state.. Suppose the number of the states is 8, the valid states will be 0, 1~7. In this case if the word value is 8 or higher, the system will display the shape of last state.

Restrictions

In label dialog, Language 1 is able to change attribute settings, and for Language 2~8, only font size can be changed and other settings follows language 1.

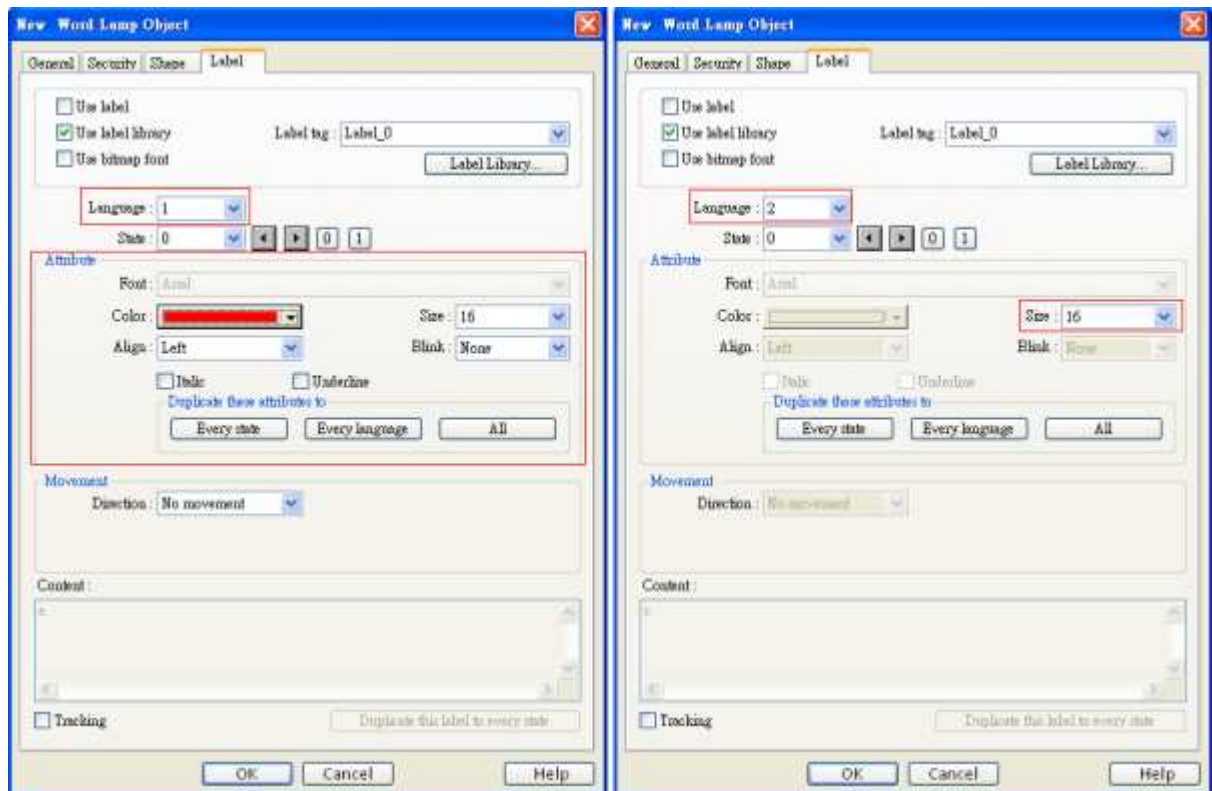

13.3 Set Bit

Overview

The **[Set Bit]** object provides two operation modes: the “manual operation” mode defines a touch area, users can activate the touch area to set the state of the bit device to be ON or OFF. When users select the “automatic operation” mode, the operation will be automatically activated in pre-configured conditions, the touch area has no action in any circumstance.

Configuration

Click the **[Set Bit]** icon in the toolbar and the **[New Set Bit Object]** dialogue box will appear, fill in each items and press **[OK]** button, a new Set Bit object will be created. See the pictures below.

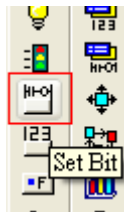

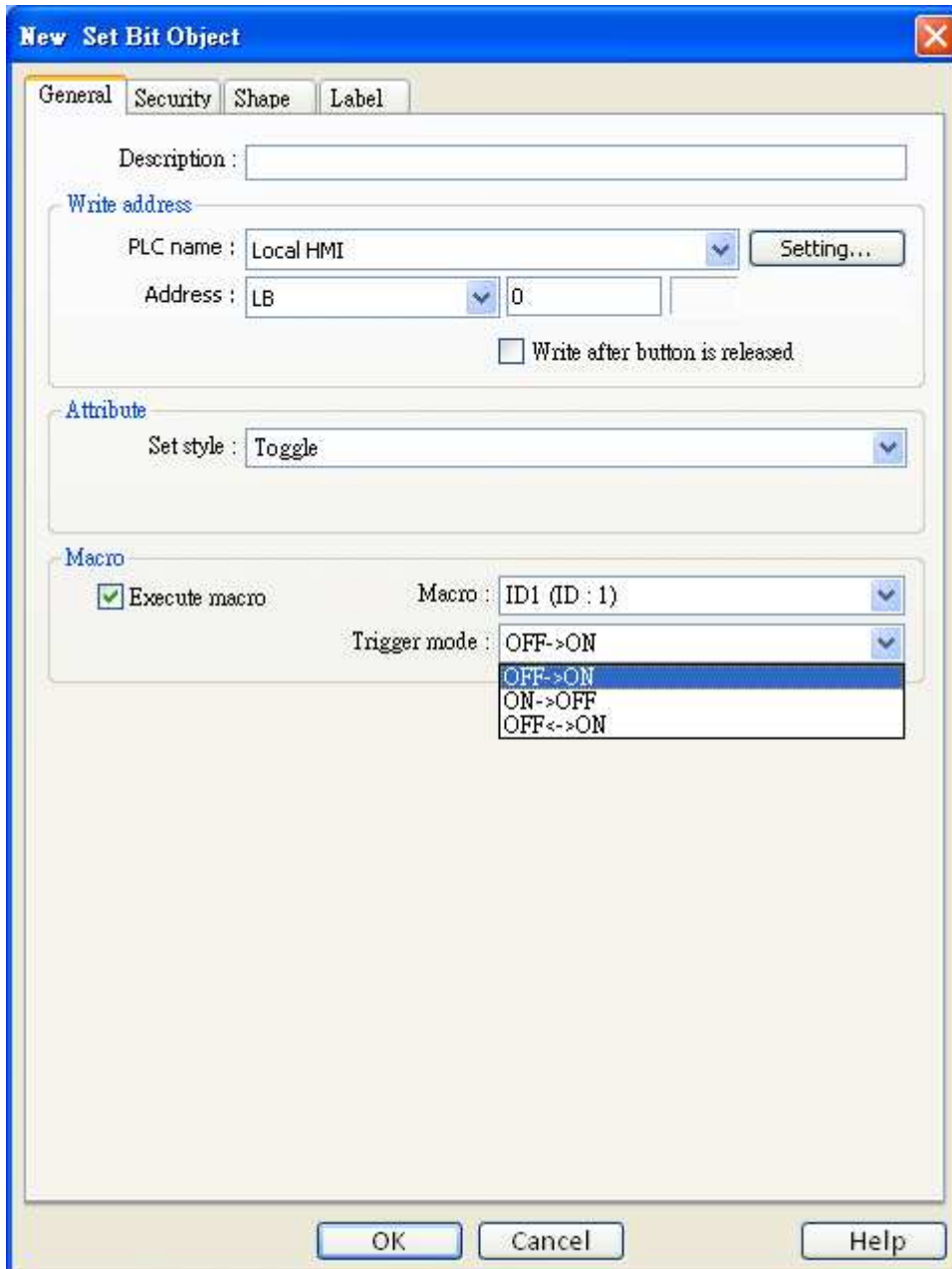

Setting	Description
Write address	Click [Setting...] to select the [PLC name] , [Device type] , [Address] , [System tag] , [Index register] of the bit device that system set value to. Users can also set address in [General] tab while adding a new object.

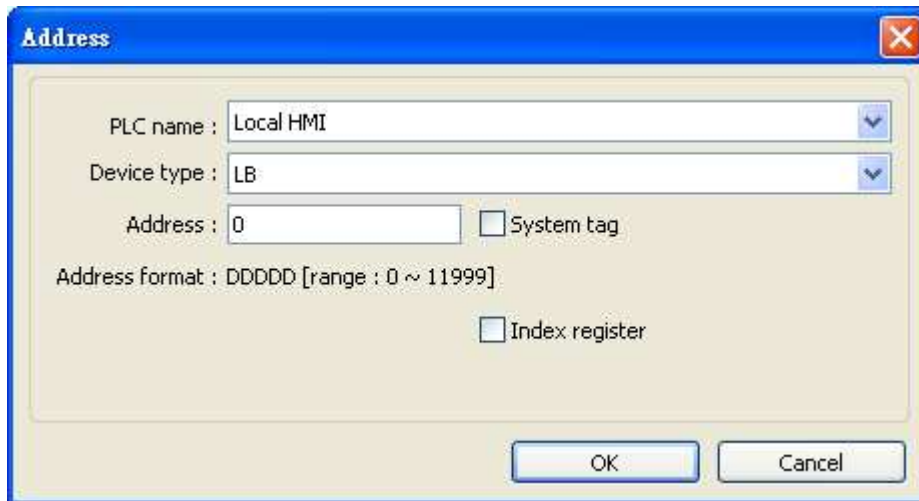

[Write after button is released]

If this function is selected, the operation is activated after button is touched and released, otherwise, if not selected, operation will be activated once the button is touched. If the “Momentary” switch is selected as the operation mode, the [Write after button is released] function will be ignored.

**Attribute
[Set Style]**

Please refer to the following description for different types of operation mode.

Set style	Description
Set ON	When the operation is activated, the bit device will be set to ON.
Set OFF	When the operation is activated, the bit device will be set to OFF.
Toggle	When the operation is activated, the bit device will be set from ON to OFF or from OFF to ON.
Momentary	When touch and hold the area, the bit device will be set to ON, and the bit device will be set to OFF once the finger removes from area.
Periodical toggle	The state of the bit device will be switched between ON and OFF periodically. Operation's time interval can be selected in the combo box showed in the picture below: <div style="border: 1px solid gray; padding: 2px; width: fit-content;"> Time interval : 1.0 second(s) </div>
Set ON when	When the window containing the Set Bit

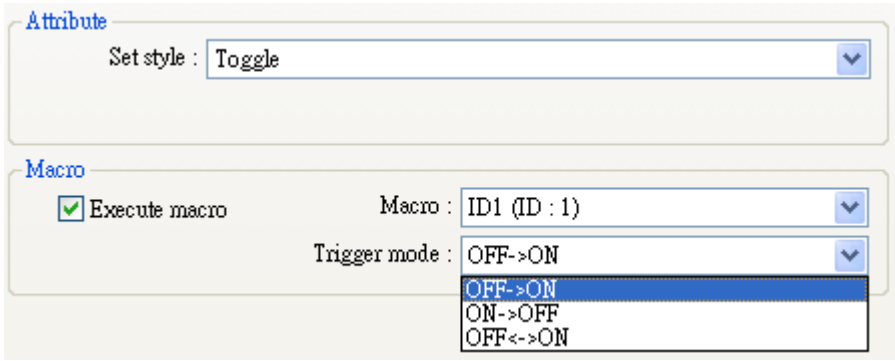
	<table border="1"> <tbody> <tr> <td>window opens</td> <td>object is opened, the bit device will be automatically set to ON.</td> </tr> <tr> <td>Set OFF when window opens</td> <td>When the window containing the Set Bit object is opened, the bit device will be automatically set to OFF.</td> </tr> <tr> <td>Set ON when window closes</td> <td>When the window containing the Set Bit object is closed, the bit device will be automatically set to ON.</td> </tr> <tr> <td>Set OFF when window closes</td> <td>When the window containing the Set Bit object is closed, the bit device will be automatically set to OFF.</td> </tr> <tr> <td>Set ON when backlight on</td> <td>When the backlight is turned on, the bit device is automatically set ON.</td> </tr> <tr> <td>Set OFF when backlight on</td> <td>When the backlight is turned on, the bit device is automatically set OFF.</td> </tr> <tr> <td>Set ON when backlight off</td> <td>When the backlight is turned off, the bit device is automatically set ON.</td> </tr> <tr> <td>Set OFF when backlight off</td> <td>When the backlight is turned off, the bit device is automatically set OFF.</td> </tr> </tbody> </table>	window opens	object is opened, the bit device will be automatically set to ON.	Set OFF when window opens	When the window containing the Set Bit object is opened, the bit device will be automatically set to OFF.	Set ON when window closes	When the window containing the Set Bit object is closed, the bit device will be automatically set to ON.	Set OFF when window closes	When the window containing the Set Bit object is closed, the bit device will be automatically set to OFF.	Set ON when backlight on	When the backlight is turned on, the bit device is automatically set ON.	Set OFF when backlight on	When the backlight is turned on, the bit device is automatically set OFF.	Set ON when backlight off	When the backlight is turned off, the bit device is automatically set ON.	Set OFF when backlight off	When the backlight is turned off, the bit device is automatically set OFF.
window opens	object is opened, the bit device will be automatically set to ON.																
Set OFF when window opens	When the window containing the Set Bit object is opened, the bit device will be automatically set to OFF.																
Set ON when window closes	When the window containing the Set Bit object is closed, the bit device will be automatically set to ON.																
Set OFF when window closes	When the window containing the Set Bit object is closed, the bit device will be automatically set to OFF.																
Set ON when backlight on	When the backlight is turned on, the bit device is automatically set ON.																
Set OFF when backlight on	When the backlight is turned on, the bit device is automatically set OFF.																
Set ON when backlight off	When the backlight is turned off, the bit device is automatically set ON.																
Set OFF when backlight off	When the backlight is turned off, the bit device is automatically set OFF.																
Macro	<p>Users can use [set bit] object to activate macro commands. Macro commands have to be built before configure this function. Please refer to related chapter on how to edit Macros.</p>																
Set style	 <p>When [Set style] is selected as [Toggle], there are three different modes to trigger macro command, i.e. OFF->ON, ON->OFF, or ON<->OFF.</p>																

13.4 Set Word

Overview

The **[Set Word]** object provides two operation modes: the “manual operation” mode and the “automatic operation” mode. The “manual operation” mode defines a touch area, and users can activate the area to set the value of the word device. When users select the “automatic operation” mode, the operation will be automatically activated in pre-configured conditions, the touch area has no action in any circumstance.

Configuration

Click the **[Set Word]** icon in the toolbar and the **[New Set Word Object]** dialogue box will appear, fill in each items and press **[OK]** button, a new Set Word object will be created. See the pictures below.



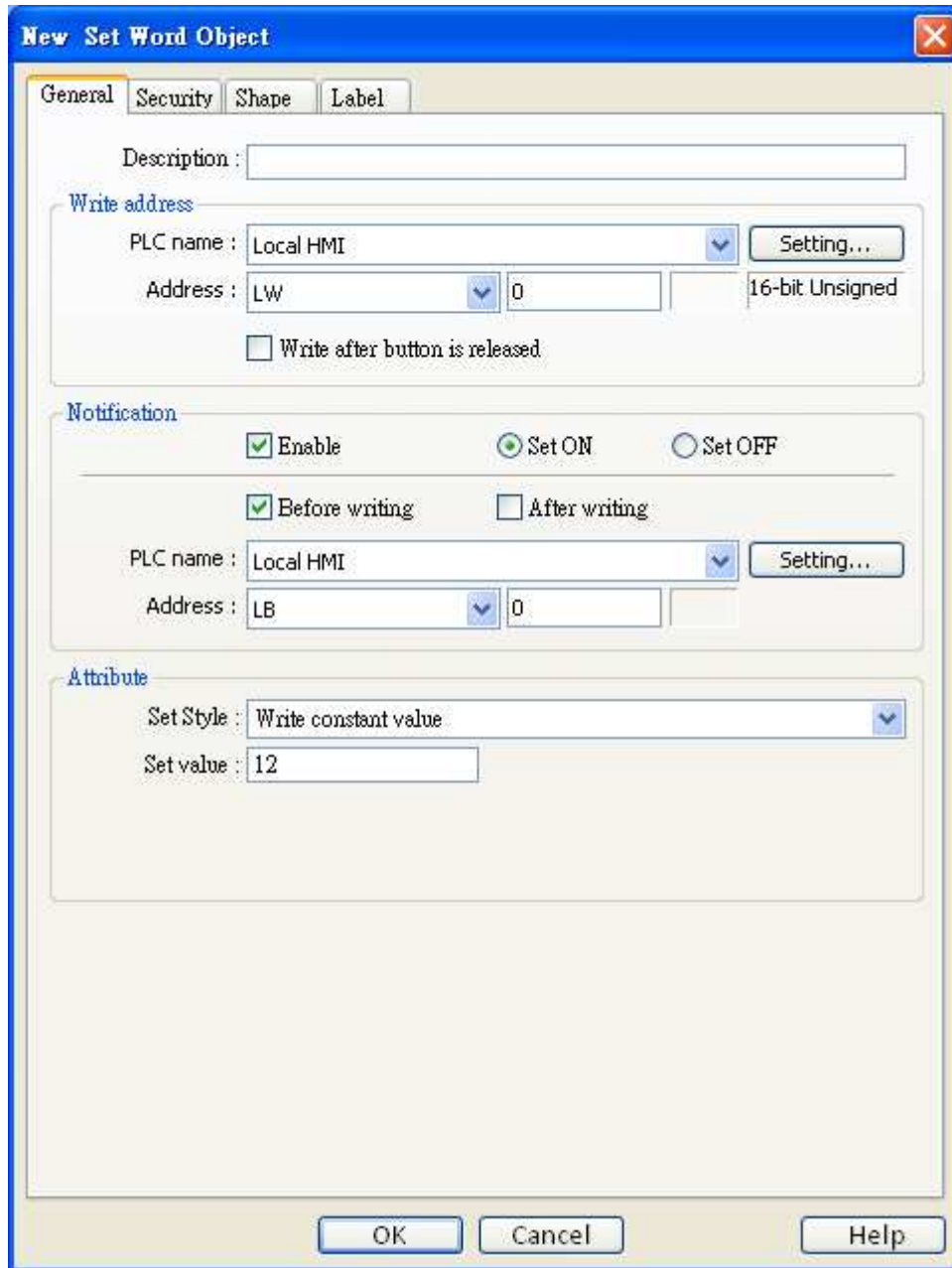

Setting	Description
Write address	Click [Setting...] to Select the [PLC name] , [Device type] , [Address] , [System tag] , [Index register] of the word device that system set value to. Users can also set address in [General] tab while adding a new object.

[Write after button is released]

If this function is selected, the operation is activated after button is touched and released, otherwise, if not selected, operation will be activated once the button is touched.

Notification

When this function is selected, in the “manual operation” mode, the state of the designated bit device will be set to [ON] or [OFF] after/before the operation is completed.

[Before writing] / [After writing]

Set the state of the designated bit device before or after writing to word device.

Click **[Setting...]** to Select the **[PLC name]**, **[Device type]**, **[Address]**, **[System tag]**, **[Index register]** of the Notification bit that system set value to.

Users can also set the address in the Notification area.

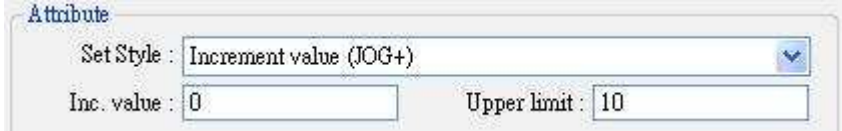
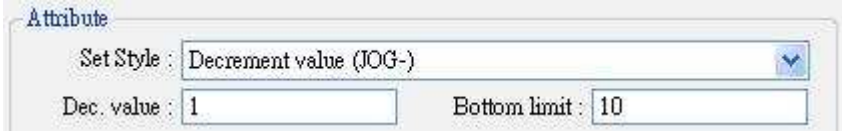
Attribute	<p>[Set style] Set the operation mode. The available modes for selection are listed as follows:</p>
	<p>a. Write constant value</p> <p>Set constant function. When the operation is activated, the [Set value] will be written into the word device. The constant's format (16-bit BCD, 32-bit BCD, ...) depends on the format of [Write address].</p> 
	<p>b. Increment value (JOG+)</p> <p>Increase value function. When the operation is activated, the [Inc. value] will be added to the value of the word device, and the result won't exceed the value [Upper limit].</p> 
	<p>c. Decrement Value (JOG-)</p> <p>Decrease value function. When the operation is activated, the [Dec. value] will be subtracted from the value of the word device, and the result won't go less than the value [Bottom limit].</p> 
	<p>d. Press and hold increment (JOG++)</p> <p>Press and hold increment function. When the touch and hold gets longer than the time set in [JOG delay], the value of the word device will be added by the value set in [Inc. value] at the speed set in [JOG speed], and the result won't exceed the value in [Upper limit].</p>

Attribute

Set Style : Press and hold increment (JOG++)

Inc. value : 1 Upper limit : 10

JOG delay : 1.0 second(s) JOG speed : 0.5 second(s)

e. Press and hold increment (JOG--)

Press and hold decrement function. When the touch and hold gets longer than the time set in **[JOG delay]**, the value of the word device will be subtracted by the value set in **[Dec. value]** at the speed set in **[JOG speed]**, and the result won't go less than the value in **[Bottom limit]**.

Attribute

Set Style : Press and hold decrement (JOG--)

Dec. value : 1 Bottom limit : 0

JOG delay : 1.0 second(s) JOG speed : 0.5 second(s)

f. Periodical JOG++

Periodically increment function. A set word object can use the interval set in **[Time interval]** and the value set in **[Inc. value]** to automatically increase the value of the word device, and the result won't exceed the value in **[Upper limit]**.

Attribute

Set Style : Periodic JOG++ (up->0->up->...)

Inc. value : 1 Upper limit : 0

Time interval : 1.0 second(s)

g. Automatic JOG++

Periodically decrement function. A set word object can use the interval set in **[Time interval]** and the value set in **[Inc. value]** to automatically increase the value of the word device, and the result won't exceed the value in **[Upper limit]**.

Attribute

Set Style : Automatic JOG++ (up to high limit) ▼

Inc. value : 0 Upper limit : 10

Time interval : 0.5 second(s) ▼

h. Automatic JOG--

Periodically decrement function. A set word object can use the interval set in **[Time interval]** and the value set in **[Dec. value]** to automatically decrease the value of the word device, and the result won't go less than the value in **[Bottom limit]**.

Attribute

Set Style : Automatic JOG-- (down to low limit) ▼

Dec. value : 1 Bottom limit : 0

Time interval : 1.0 second(s) ▼

i. Periodical bounce

Periodically bouncing function. A Set word object will add the value set in **[Inc. value]** to the value of the word device with the regulated interval set in **[Time interval]** until the result value reaches the value in **[Upper limit]**, and then subtract the value set in **[Inc. value]** from the value of the word device with the regulated interval set until the result value reaches the value in the **[Bottom limit]**. For example, the value in the word device will change periodically from 0~10 then from 10~0.

Attribute

Set Style : Periodic step up (low to high...) ▼

Low limit : 0 High limit : 10

Inc. value : 1

Time interval : 0.5 second(s) ▼

j. Periodical step up

Stepping up function. A Set word object will add the value set in **[Inc. value]** to the value of the word device with the regulated interval set

in **[Time interval]** until the result value reaches the value in the **[High limit]**, and the value of the word device will return to the value of the **[Low limit]** and then repeat the action to keep the value in an active state. In the example shown below, the value of the word device will change periodically in order of 0, 1, 2,..., 9, 10, 0, 1, 2,

The screenshot shows the 'Attribute' dialog box with the following settings:

- Set Style: Periodic step up (low to high...)
- Low limit: 0
- High limit: 10
- Inc. value: 1
- Time interval: 0.5 second(s)

k. Periodical step down

Stepping down function. A Set word object will subtract the value set in **[Dec. value]** from the value of the word device with the regulated interval set in **[Time interval]** until the result value reaches the value of the **[Low limit]**, and the value of the word device will return to the value of the **[High limit]** and then repeat the action to keep the value in an active state. In the example shown below, the value of the word device will change periodically in order of 10, 9, 8,..., 1, 0, 10, 9, 8,

The screenshot shows the 'Attribute' dialog box with the following settings:

- Set Style: Periodic step down (high to low...)
- Low limit: 0
- High limit: 10
- Dec. value: 1
- Time interval: 0.5 second(s)

l. Set when window opens

When the window containing the object is opened, the value of **[Set value]** will be automatically written into the word device.

The screenshot shows the 'Attribute' dialog box with the following settings:

- Set Style: Set when window opens
- Set value: 5

m. Set when window closes

When the window containing the object is closed, the value of **[Set value]** will be automatically written into the word device.

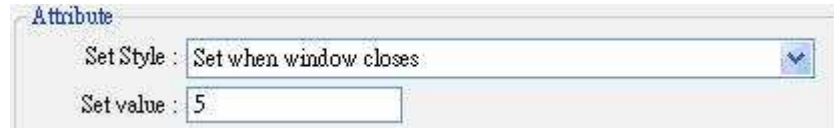

The screenshot shows a dialog box titled "Attribute". It contains two fields: "Set Style" with a dropdown menu set to "Set when window closes" and "Set value" with a text input field containing the number "5".

n. Set when backlight on

When the backlight is turned from off to on, the value of **[Set value]** will be automatically written into the word device.

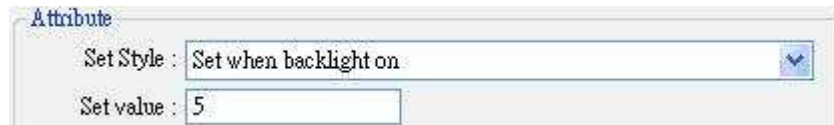

The screenshot shows a dialog box titled "Attribute". It contains two fields: "Set Style" with a dropdown menu set to "Set when backlight on" and "Set value" with a text input field containing the number "5".

o. Set when backlight off

When the backlight is turned from on to off, the value of **[Set value]** will be automatically written into the word device.

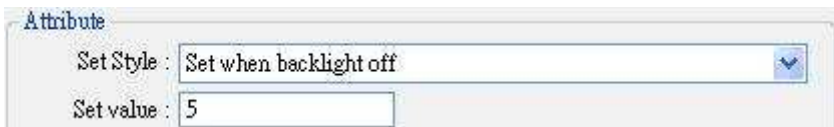

The screenshot shows a dialog box titled "Attribute". It contains two fields: "Set Style" with a dropdown menu set to "Set when backlight off" and "Set value" with a text input field containing the number "5".

13.5 Function Key

Overview

Function key object is used to change base window, pop-up window and close window. It can also be used to design the keypad buttons.

Configuration

Click the **[Function Key]** icon in the toolbar and the **[Function Key Object's Properties]** dialogue box will appear, fill in each items and press the **[OK]** button, a new function key object will be created. See the pictures below.





Function Key object provides the following operation modes:

Setting	Description
[Active after button is released]	If this function is selected, the operation is activated when touched and released. If the function is not selected, the operation is activated once being touched.
[Change full-screen window]	Change base window. NOTE: Do not use this function to pop up the window which has been opened by direct / indirect window object.

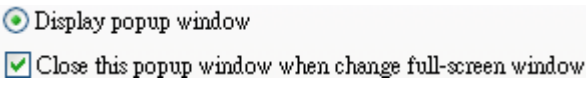
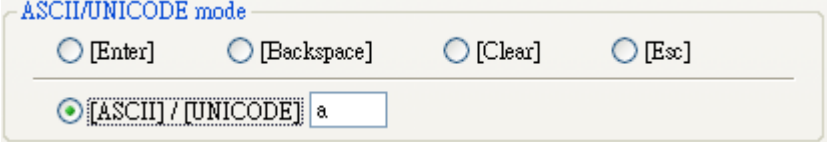
[Change common window]	Change common window; refer to the “windows” chapter for related information.
[Display popup window]	Pop up window. The pop up window must be on the top of the base window. There is a [Close this popup window when parent window is closed] option with this function, see the picture below; when the function is selected, the pop up window will be closed when executing change base window. Otherwise, users have to set a “Close” button on the pop-up window to close the window. 
[Window no.]	This is used to select the window no. when performing [change base window], [change common window], and [pop up the window]
[Return to previous window]	This is used to return to the previous base window. For example, when changing window 10 to window 20, users can use this function to return to window 10. This function is only available for base window change.
[Close window]	Close the pop-up windows on the top of the base window.
Items in ASCII/UNICODE mode	<p>[ASCII/UNICODE mode] is used as elements to configure a keypad, the keypad is used where numbers or texts are needed to be input to the [numeric input] object or [ASCII input] object. Refer to the “Designing and Using Keypad” chapter for detailed information.</p>  <p>[Enter] Same as the keyboard’s “enter” function.</p> <p>[Backspace] Same as the keyboard’s “backspace” function.</p> <p>[Clear] To clear the temperate input alphanumeric strings stored in the buffer.</p> <p>[Esc] Same as the [Close window] function, it is used to close the keyboard window.</p> <p>[ASCII/UNICODE] To set the characters that are input in the numeric input object and the ASCII input object. Digital characters such as 0, 1, 2... or ASCII characters like a, b,</p>

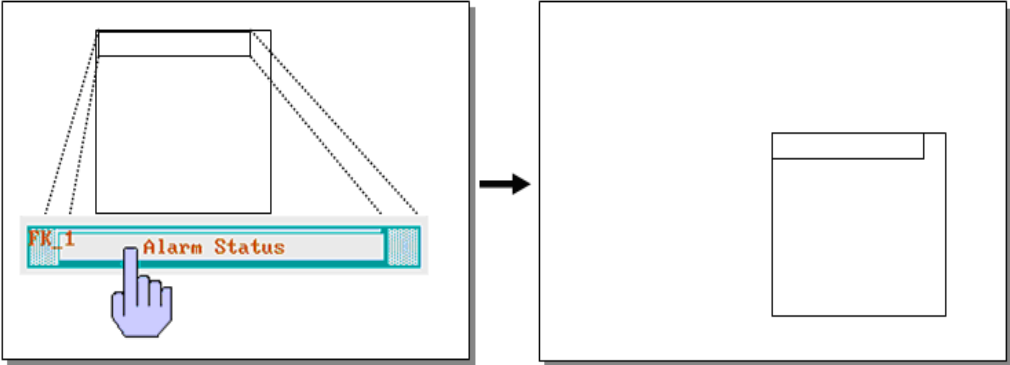
	c,...etc. are available selection.
[Execute Macro]	Macro commands are executed with this selection. Macro commands have to be built before users choose this function. Please refer to related chapter on how to edit Macros. <div data-bbox="445 409 1267 495" style="border: 1px solid #ccc; padding: 5px; margin: 10px 0;"> <input checked="" type="radio"/> Execute macro Macro : macro 1 (ID : 1) </div>
[Window title bar]	A [function Key] which is defined as Window Title Bar can move the popup window position on the screen. Firstly users can select the popup window that has the title bar, and then click another position to move the window. <p>Note: this function is only available on indirect/direct window when [no title bar] is selected.</p> <div data-bbox="491 813 1506 1265" style="text-align: center;">  <p style="margin-left: 150px;">Select the window title bar firstly.</p> <p style="margin-left: 450px;">Touching the screen for the new position the popup window will be moved.</p> </div>
[Screen hard copy]	Hardcopy current display screen to the printer connected with MT8000. Before using this function, please choose printer model in [System Parameter] / [Model] / [printer] . If printer does not support color print, user can select grayscale to have a better printout effect. Black and white is for improving text printing quality. <div data-bbox="576 1641 1394 1845" style="border: 1px solid #ccc; padding: 5px; margin: 10px 0;"> <input checked="" type="radio"/> Screen hard copy Printer : HP PCL Series (USB) Mode : color black and white grayscale color Notification <input type="checkbox"/> Enable </div>
Notification	When the function is selected, MT8000 will set the state of the designated bit device to [ON] or [OFF] after the action is completed. Click [Setting...] to Select the [PLC name] , [Device type] , [Address] ,

[System tag], [Index register] of the Notification bit that system set value to. Users can also set the address in the Notification area.

Non-ASCII character input

Below we illustrate the method to input non-ascii character such as Traditional Chinese, Simplified Chinese, Japanese, Greece and so on.

Step1: Setting non-ascii fonts

Go to System parameter/Font and add non-ascii fonts in the “Fonts for non-ascii strings” list. For example, use “AR MinchoL JIS” for Japanese, ” AR MingtiM GB” for Simplified Chinese, ” AR MingtiM KSC” for Korean, ” Arial” for Greek, please refer illustration below.

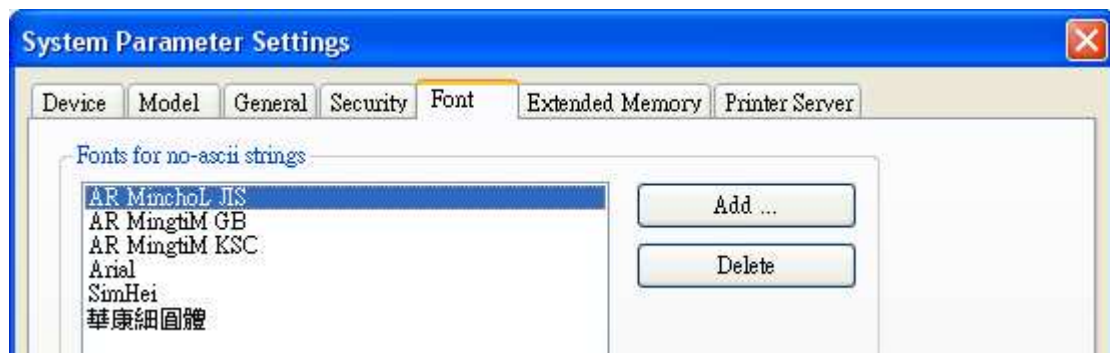

Step2: Design non-ascii input keypad

Create “window11” for non-ascii input keypad, keypad design is shown below.

```

  9
  + *10: WINDOW_010
  + *11: SimpleChinese_Keyboard
  12

```



Those objects on the window are function keys with input code in accord with the label. For example, to input "简" function key, create a function key object/General/[ASCII]/[UNICODE] mode, type in "简" in the column as below illustration.

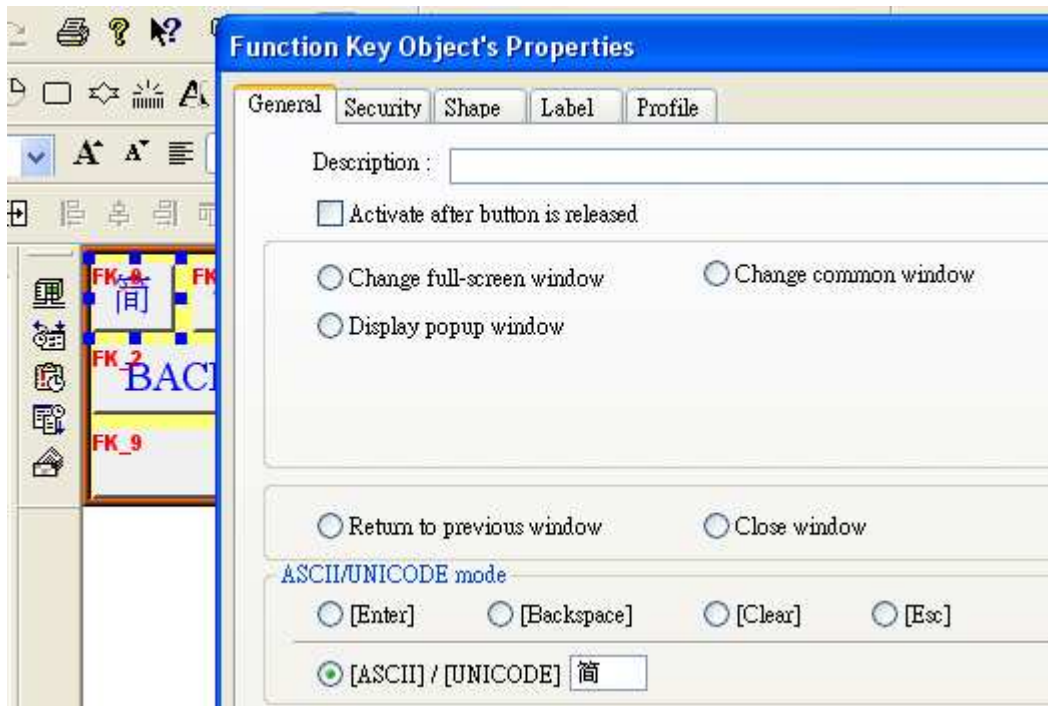

Go to Function key/Label and then select "Use label", type "简" in the content and in the Attribute/Font select "AR MingtiM GB", it must be the same as setp1's setting, as illustrated below.

The label of non-ascii function key must use the same Font. For example, in Simplified Chinese keypad, the fonts all use "AR MingtiM GB".

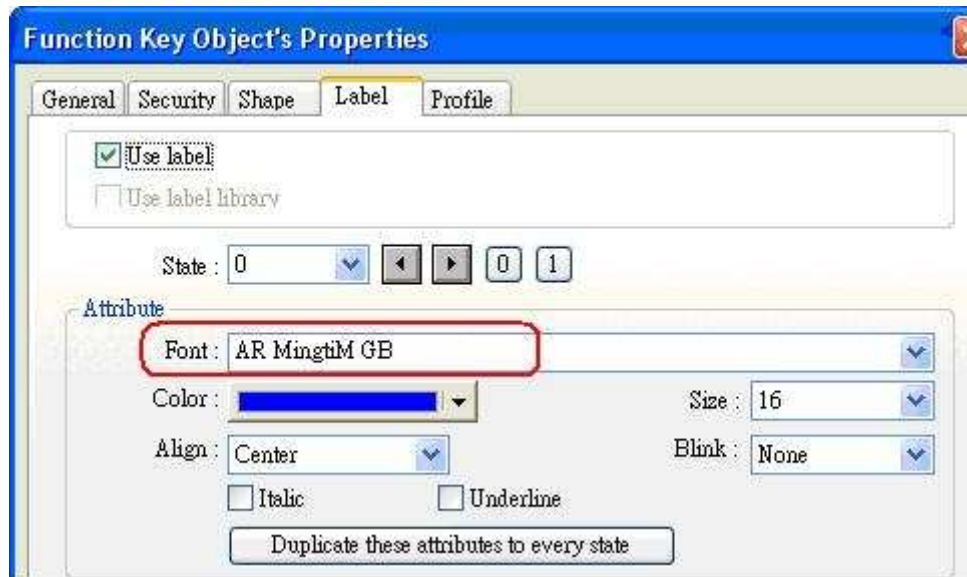

After complete the keypad configuration, add window11 into System Parameters / General / keyboard as illustration below.

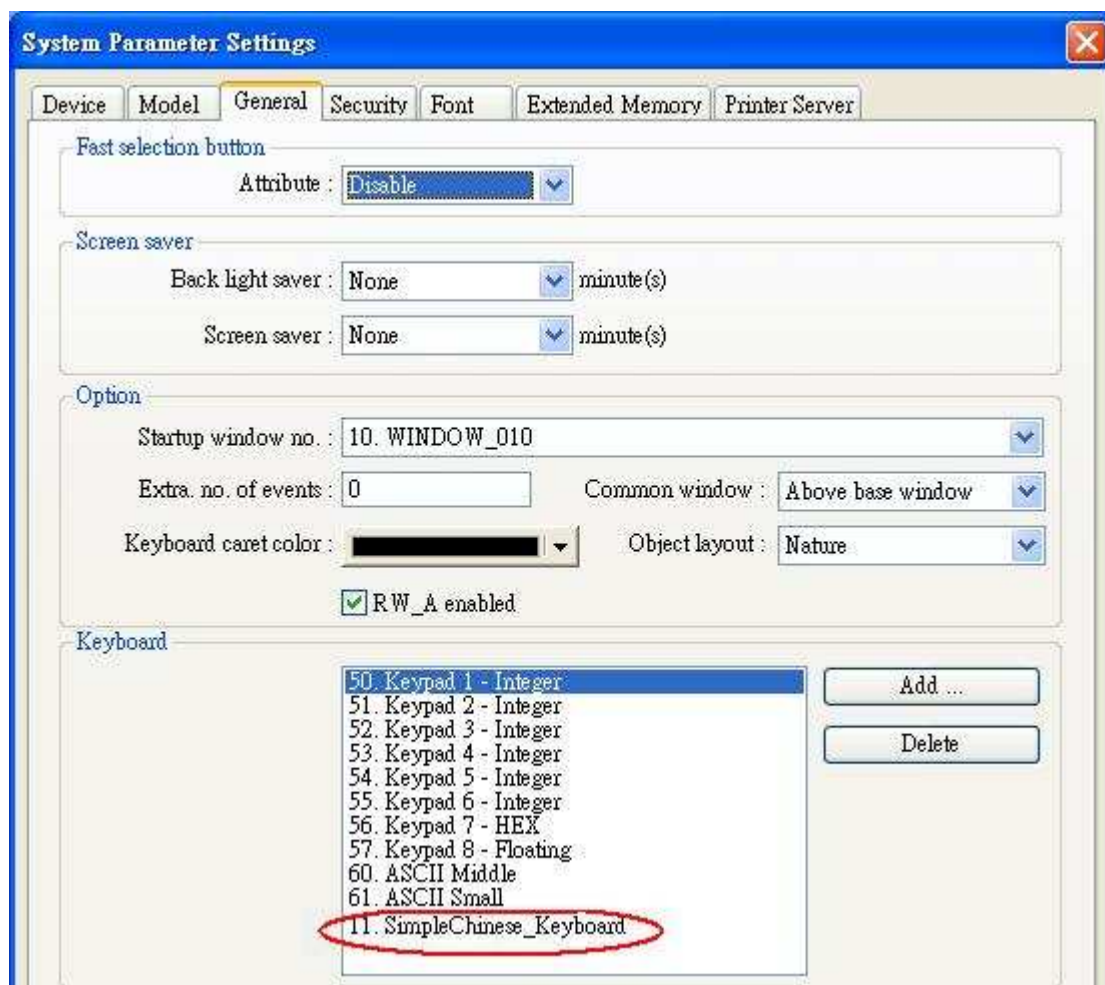

13.6 Toggle Switch

Overview

Toggle Switch object is a combination of bit lamp object and set bit object. The object can be used not only to display the state of a bit device but also to define a touch area, when activated, the state of the bit device will be set to “ON” or “OFF”.

Configuration

Click the “Toggle Switch” icon on the toolbar and the “New Toggle Switch Object” dialogue box will appear, fill in each item and press OK button, a new toggle switch object will be created. See the pictures below.





Setting	Description
Read address	Click [Setting...] to Select the [PLC name] , [Device type] , [Address] , [System tag] , [Index register] of the bit device that control the display of toggle switch state. Users can also set address in General tab while adding a new object.
	[Invert signal] Display shape with inverse state; for example, the present state is “OFF”, but it displays the shape of “ON” state.
Write	Click [Setting...] to Select the [PLC name] , [Device type] ,

address	<p>[Address], [System tag], [Index register] of the bit device that system set value to. The write address can be the same as or different from the read address.</p> <p>Users can also set address in General tab while adding a new object.</p>
	<p>[Write when button is released]</p> <p>If this function is selected, the operation is activated at touch up. If the function is not selected, the operation is activated at touch down.</p>
Attribute	<p>This is used to select the operation mode. The available operation modes for selection include “Set ON”, “Set OFF”, ”Toggle”, and ”Momentary”. Refer to the illustrations in the “Set Bit Object” section of this chapter for related information.</p>
Macro	<p>Users can execute macro command by triggering toggle switch. This function is the same as that of set bit object. Please refer to “the chapter of set bit object”.</p>

13.7 Multi-State Switch

Overview

Multi-State Switch object is a combination of word lamp object and set word object. The object can be used not only to display the state of a word device but also to define a touch area, when activated, the value of the word device can be set.

Configuration

Click the “Multi-State Switch” icon on the toolbar and the “New Multi-State Switch Object” dialogue box will appear, fill in each items, and click OK button, a new Multi-State Switch object will be created. See the pictures below.



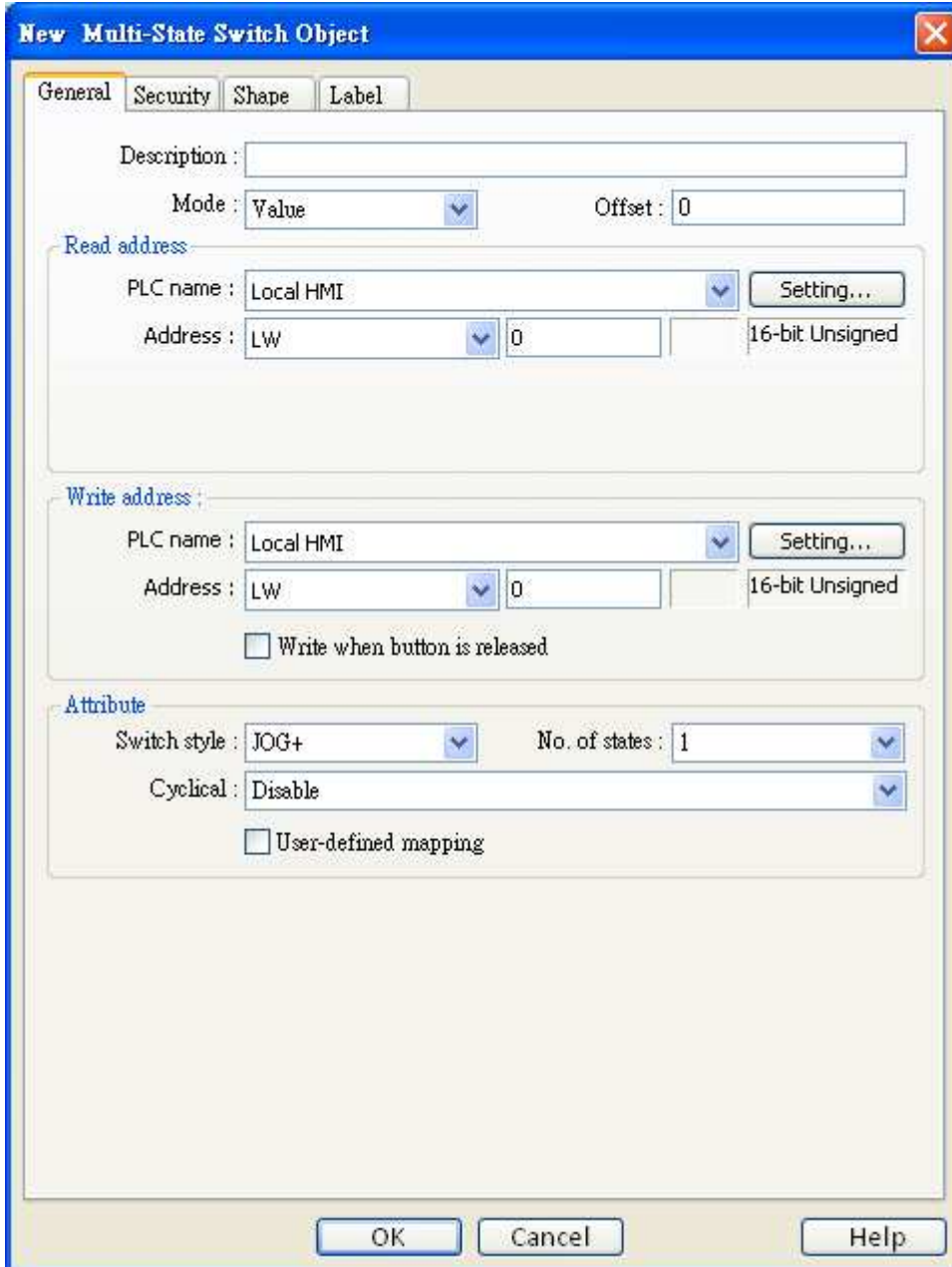

Setting	Description
[Mode]/ [Offset]	There are “Value” and “LSB” display mode. Refer to the “Word Lamp Object” section of this chapter for related information.
Read address	Click [Setting...] to Select the [PLC name] , [Device type] , [Address] , [System tag] , [Index register] of the word device that controls the display of multi-state switch. Users can also set address in General tab while adding a new object.
Write	Click [Setting...] to Select the [PLC name] , [Device type] ,

address	<p>[Address], [System tag], [Index register] of the word device that system set value to. The write address can be the same as or different from the read address.</p> <p>Users can also set address in General tab while adding a new object.</p> <p>[Write when button is released]</p> <p>If this function is selected, the operation is activated at touch up. If the function is not selected, the operation is activated at touch down.</p>
Attribute	<p>Select the object's operation mode.</p> <p>[Switch style]</p> <p>There are "JOG+" and "JOG-" for selection. When the read address is the same as the write address, the minimum value of the word value is [Offset] (state 0), and the maximum value is "[no. of state] - 1 + [Offset]". See the picture below.</p> <p style="text-align: center;"><i>Numeric Display (LWO) Multi-State (LWO), offset = 1</i></p> <div style="display: flex; justify-content: space-around; align-items: center;"> <div style="border: 1px solid gray; padding: 5px; width: 40px; text-align: center;">2</div> <div style="background-color: #0070c0; color: white; padding: 5px; width: 60px; text-align: center; font-weight: bold;">State 1</div> </div> <p>a. "JOG+"</p> <p>When the Multi-State Switch object is activated, the value of the write address will be added by 1. In the "Value" display mode, if the resulting value is equal to or larger than the value of [No. of States] + [Offset] and "Enable" in [Cyclic] is selected, the value of the write address will return to [Offset] and show the state 0; otherwise the value of the write address will maintain as ([No. of states] – 1) + [Offset] and shows the state ([No. of states no.] – 1).</p> <p>NOTE: Like the word lamp object, the state shown by Multi-State Switch object is the value of the word device subtracts [Offset].</p> <div style="border: 1px solid gray; padding: 5px; margin-top: 10px;"> <p><small>Attribute</small></p> <p>Switch style : JOG+ State no. : 5</p> <p>Cyclic : Enable</p> </div>

b. “JOG-”

When the Multi-State Switch object is activated, the value of the write address will be subtracted by 1. In the “Value” display mode, if the resulting value is smaller than the value of [Offset] and “Enable” in [Cyclic] is selected, the value of the register will change to $([\text{No. of states}] - 1) + [\text{Offset}]$ and shows the state $([\text{No. of states}] - 1)$; otherwise the value of the word device will remain in [Offset] and shows the state 0.

[User-defined mapping]

Users can modify the value of state, illegal input and error notification.

Remain current state: if input an illegal value, multi-state switch will remain current state.

Jump to error state: if input an illegal value, multi-state switch will jump to error state.

13.8 Slider

Overview

The slide object can be used to create a slot area that changes the word's value by dragging the pointer.

Configuration

Click the “Slide object” icon on the toolbar and the dialogue box will appear, fill in each items and click OK button, a new slide object will be created. See the pictures below.



New Slider Object ✖

General Outline Security Shape

Description :

Write address

PLC name : Local HMI Setting...

Address : LW 0 16-bit Unsigned

Notification

Enable Set ON Set OFF

Before writing After writing

PLC name : Local HMI Setting...

Address : LB 0

Watch address

Enable

PLC name : Local HMI Setting...

Address : LW 10 16-bit Unsigned

Setting	Description
Write	Click [Setting...] to Select the [PLC name], [Device type], [Address],

address	[System tag], [Index register] of the word device that system set value to. Users can also set address in General tab while adding a new object.
Notification	<p>Click [Setting...] to Select the [PLC name], [Device type], [Address], [System tag], [Index register] of the Notification bit that system set value to. Users can also set the address in the Notification area.</p> <p>When this function is selected, the state of the designated bit device can be set before/after the operation is completed. There are [ON] and [OFF] selection to set the state.</p> <p>[Before writing] / [After writing]</p> <p>Set the state of the designated register before or after write to the word device.</p>
Watch address	When sliding, the current value can be displayed in real-time fashion.

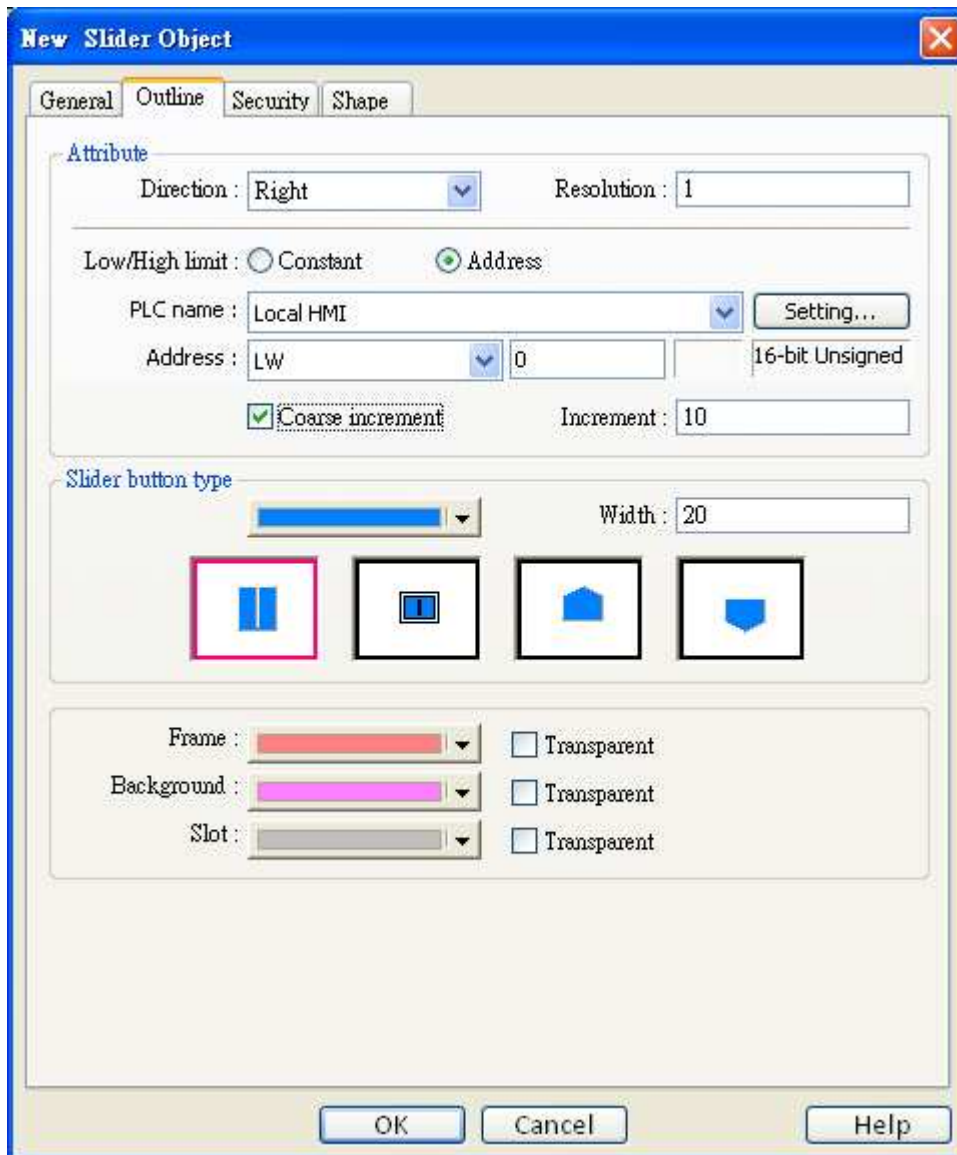

New Slider Object

General Outline Security Shape

Attribute

Direction : Right Resolution : 1

Low/High limit : Constant Address

PLC name : Local HMI Setting...

Address : LW 0 16-bit Unsigned

Coarse increment Increment : 10

Slider button type

Width : 20

Frame : Transparent

Background : Transparent

Slot : Transparent

OK Cancel Help

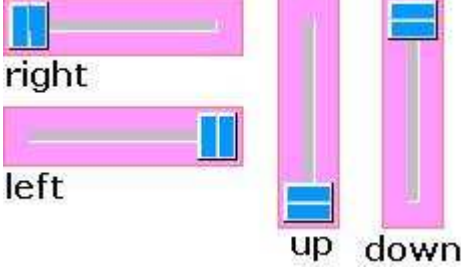
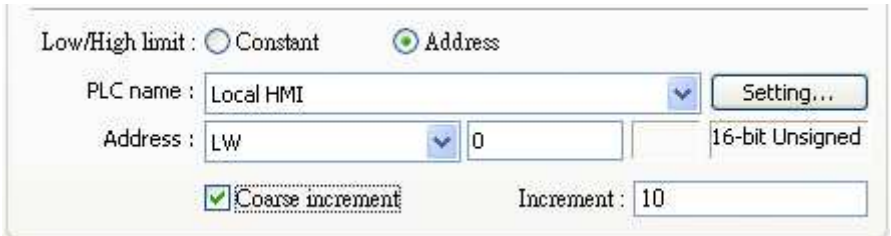
Setting	Description									
Attribute	<p>[Direction] The bar on the slide direction, i.e. left, right, up and down.</p>  <p>[Resolution] To specify the scale value of the slider, if N is the specified minimum scale value, when N=10, the numerical display shows only multiples of 10. N=5, the numerical display shows only multiples of 5. N=1, the numerical display shows only multiples of 1.</p>									
[Low limit & High limit]	<p>a. Constant The low limit and high limit of the word device is set as constant value. i.e. [Input low] and [Input high].</p> <p>b. Address The low / high limit of the word device is controlled by a designated address. Click [Setting...] to Select the [PLC name], [Device type], [Address], [System tag], [Index register] of designated address or users can also set address in Attribute.</p>  <table border="1" data-bbox="518 1765 1385 1915"> <thead> <tr> <th>Control address</th> <th>Low Limit</th> <th>High Limit</th> </tr> </thead> <tbody> <tr> <td>16-bit format</td> <td>Address+0</td> <td>Address+1</td> </tr> <tr> <td>32-bit format</td> <td>Address+0</td> <td>Address+2</td> </tr> </tbody> </table> <p>[Coarse increment:] If this option is selected, the word value will increase/decrease one</p>	Control address	Low Limit	High Limit	16-bit format	Address+0	Address+1	32-bit format	Address+0	Address+2
Control address	Low Limit	High Limit								
16-bit format	Address+0	Address+1								
32-bit format	Address+0	Address+2								

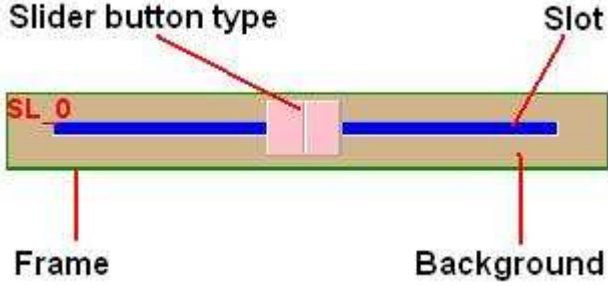
	[increment] value for every touch activation. If not, the word value will be set the value in accord with the touch activated point.
Slider button type	There are four slider button types for selection. You also can adjust the width of moving piece.
Color	This is used to select slide object frame, background and slot's color. 

13.9 Numeric Input and Numeric Display

Overview

Both of the Numeric Input object and the Numeric Display object can be used to display the value of the word devices. The difference is the numeric input object can be used to input data from the keypad, the input value is written to the designated word devices.

Configuration

Click the “Numeric Input” or “Numeric Display” icon on the toolbar and the “New Numeric Input Object” or “New Numeric Display Object” dialogue box will appear, fill in each item, click OK button and a new “Numeric Input Object” or “Numeric Display Object” will be created. See the pictures below.

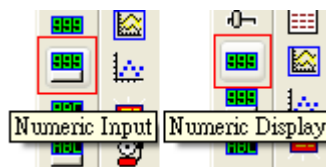

The difference between the “New Numeric Display Object” and “New Numeric Input Object” dialogue boxes is that the latter has the settings for “Notification” and keypad input while the former doesn’t have. The picture below shows the [General] tab in “New Numeric Input Object”.

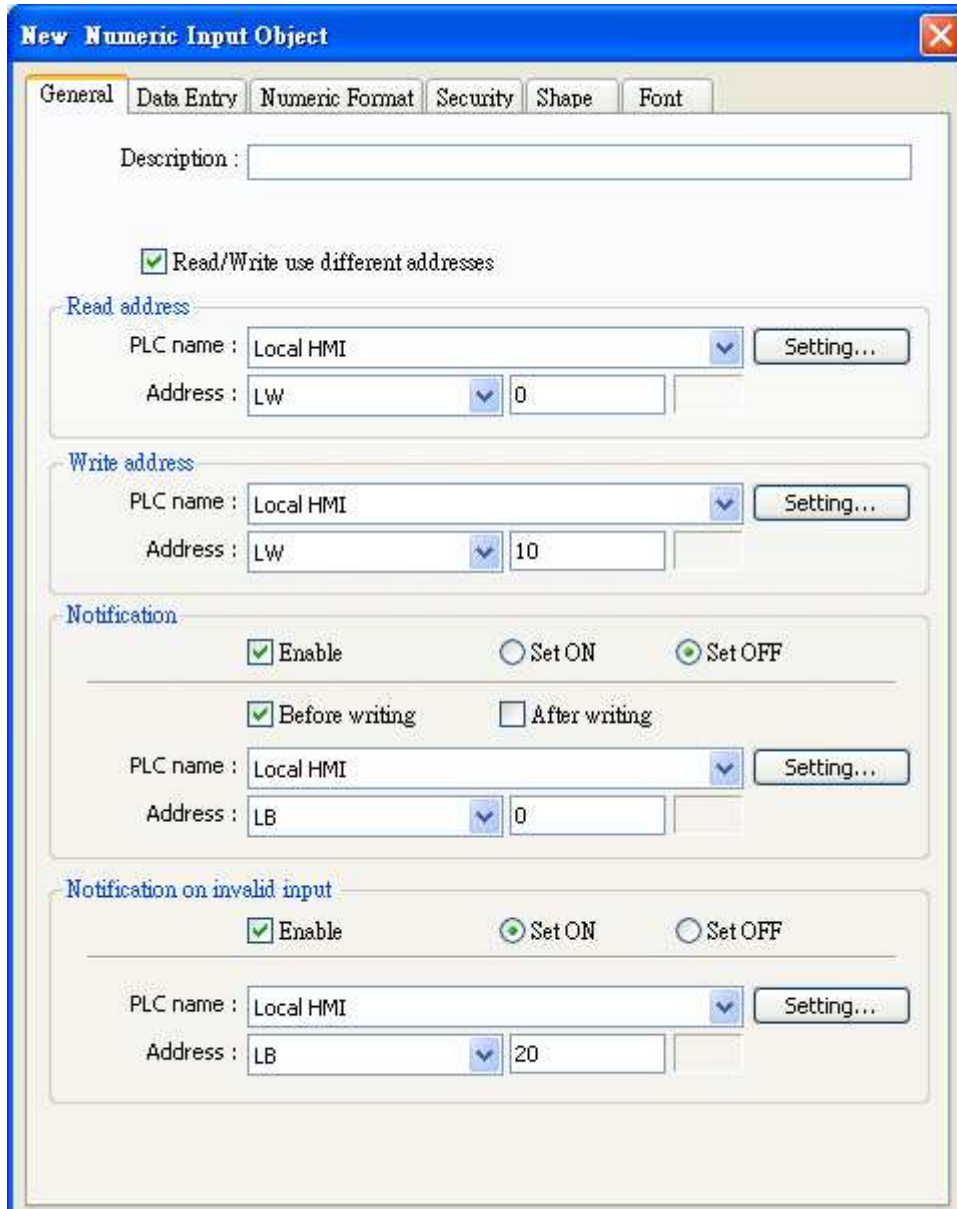

New Numeric Input Object

General | Data Entry | Numeric Format | Security | Shape | Font

Description :

Read/Write use different addresses

Read address

PLC name : Local HMI

Address : LW

Write address

PLC name : Local HMI

Address : LW

Notification

Enable Set ON Set OFF

Before writing After writing

PLC name : Local HMI

Address : LB

Notification on invalid input

Enable Set ON Set OFF

PLC name : Local HMI

Address : LB

Setting	Description
Read/Write use different address	Numeric Input object is provided with [Read/Write use different addresses] selection, users can set different addresses for Read and for Write data.
Read address	Select the [PLC name] , [Device type] , [Address] of the word device that system display its value and write new data to it.
Write	Select the [PLC name] , [Device type] , [Address] of the word device that

address	system writes to.
Notification	<p>When this function is selected, the state of the designated bit device will be set to [ON] or [OFF] after/before the value of the register is changed successfully.</p> <p>Click [Setting...] to Select the [PLC name], [Device type], [Address], [System tag], [Index register] of the Notification bit that system set value to. Users can also set the address in the Notification area.</p> <p>[Before writing] / [After writing]</p> <p>Set the state of the designated bit device before or after update the word device.</p>
Notification on valid input	When inputting invalid values, it can now automatically set the status of designated address.

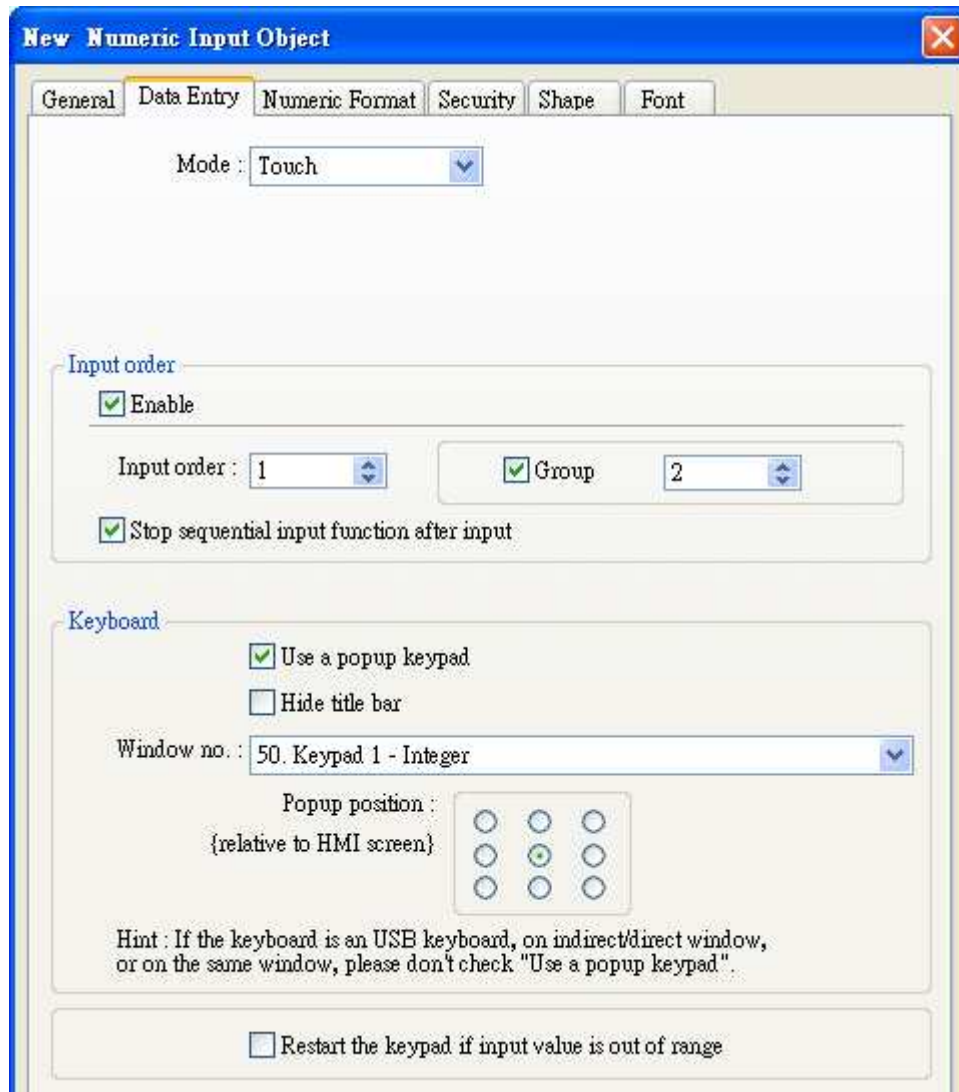

Setting	Description
[Mode]	<ul style="list-style-type: none"> • [Touch] The object enters input state when a user touches it. • [Bit control] The object enters input state when turning ON the designated bit register, and ends input state when turning OFF. Notice that if there is another input object already in input state, turning ON the designated bit register won't make this input object enters input state until the previous one ends inputting data.
Allow input bit address	Click [Setting...] to Select the [PLC name] , [Device type] , [Address] , [System tag] , [Index register] of the bit register that controls the object enters and ends input state. Users can also set address in Data Entry tab.

Input order

By setting Input Order and Input Order Group, users can continuously input data between multiple input objects. The system will automatically transfer input state to the next input object after users complete inputting data, i.e. press ENT.

- **Enable**

Select [Enable] and set Input Order to enable this feature. Furthermore, users can also select [Group] to set Input Order Group.

- a. The range of Input Order: 1 ~ 511.
- b. The range of Input Order Group: 1 ~ 15.
- c. The Input Order Group of an input object with [Group] unselected is 0.

- **Criterion of searching the next input object**

- a. The system only searches it among the input objects with the same Input Order Group.
- b. The system picks the input object with smaller Input Order to enter input state before another one with bigger Input Order.
- c. If two input objects have the same Input Order Group and Input Order, the system picks the one at bottom layer to enter input state first.

- **When selecting [Touch] as Mode**

Refer to the following illustration, when users complete inputting data on "AE_2", the system transfers input state to "AE_0". The reason why not transferring to "NE_0" is because the Input Order Group of "NE_0" is different from that of "AE2".

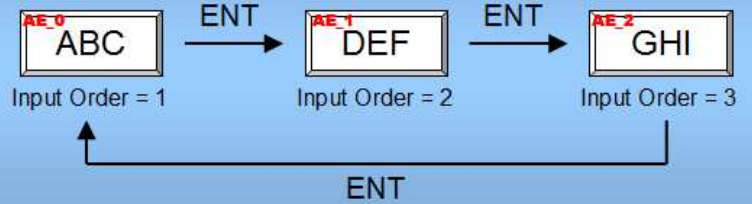
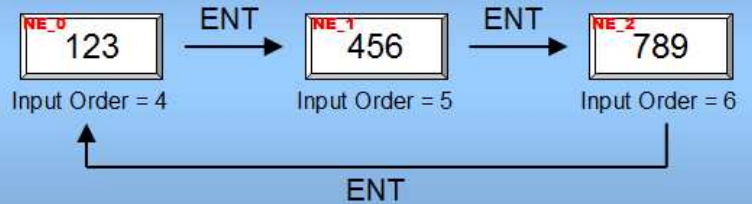
Group 1**Group 2****[Stop sequential input function after input]**

If the objects in one group are not set with this function, the input order would be:

[Order 1] -> [Order 2] -> [Order 3] -> [Order 4] -> [Order 1]
-> [Order 2] ->.....

And the loop goes on until the ESC button is pressed.

If one of the objects in the group is set to [Stop sequential input function after input] (Take Order 4 Object as shown below), the input order would be:

[Order 1] -> [Order 2] -> [Order 3] -> [Order 4] -> fin

Upon the completion of input of Order 4 Object (press ENTER), the input will stop at this point.

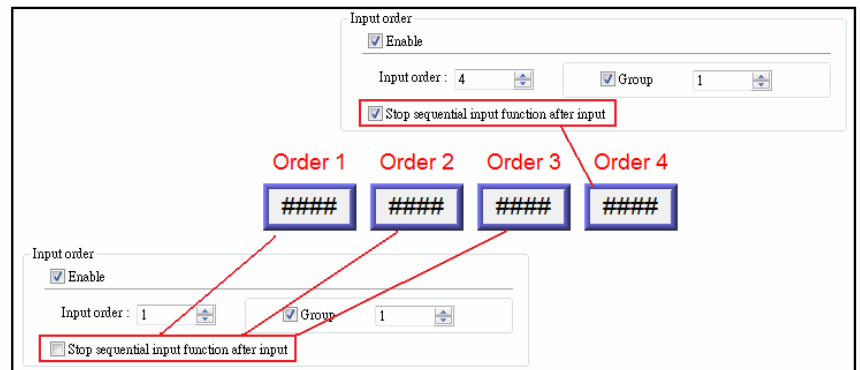

- **When selecting [Bit control] as Mode**

- Users have to specify an Input Order for the object.
- No need to set Input Order Group because all the input objects with [Bit control] as Mode have the same Input Order Group that is different from any input object with [Touch] as Mode.

Keyboard

- **Select [Use a popup keypad]**

Specify the pop-up position for the keyboard window. The system displays the keyboard window on inputting data and closes it on end.

- **Unselect [Use a popup keypad]**

The system does not automatically display keyboard window. Users have to complete the input process via following methods:

- Design a custom keypad and place it in the same window with the input object.
- Use an external keyboard.

- **Hide title bar**

Keypads without title bar can be selected for Numeric Input / ASCII Input object.

- **Restart the keypad if input value is out of range**

For Input Value object, re-input can be automatically requested when input error occurs.

- When selecting [Bit control] as Mode, the system will automatically unselect [Use a popup keypad] in [Keyboard].

The picture below shows the [Numeric Format] tab, included in both of the numeric input object and the numeric display object, which is to set the data display format.

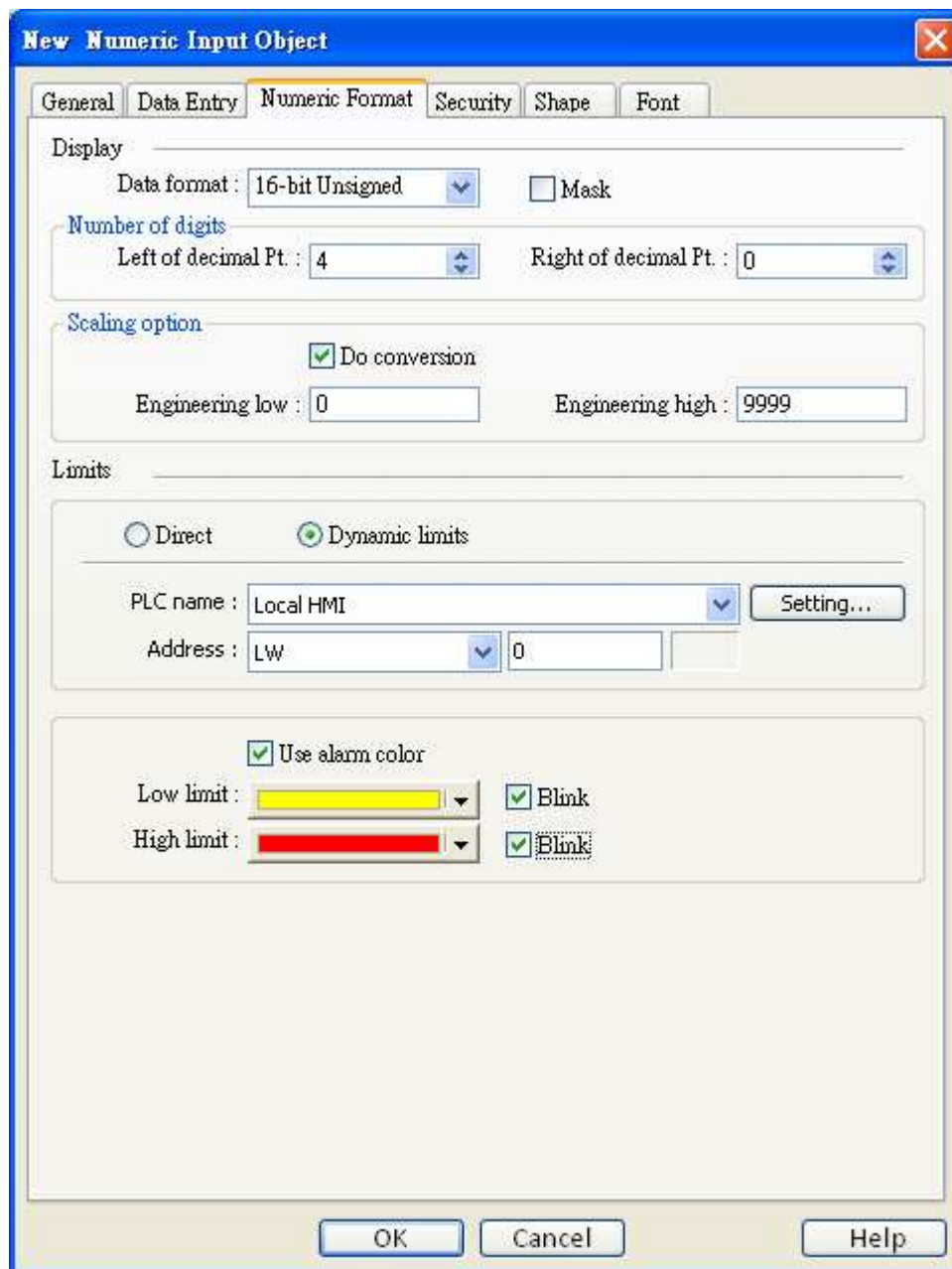

Setting	Description
---------	-------------

Display	<p>[Data format] To select the data format of the word device designated by the “Read address”. The selection list is shown as follows:</p> <table border="1" data-bbox="427 353 699 1070"> <tr> <td>Format</td> </tr> <tr> <td>16-bit BCD</td> </tr> <tr> <td>32-bit BCD</td> </tr> <tr> <td>16-bit Hex</td> </tr> <tr> <td>32-bit Hex</td> </tr> <tr> <td>16-bit Binary</td> </tr> <tr> <td>32-bit Binary</td> </tr> <tr> <td>16-bit Unsigned</td> </tr> <tr> <td>16-bit Signed</td> </tr> <tr> <td>32-bit Unsigned</td> </tr> <tr> <td>32-bit Signed</td> </tr> <tr> <td>32-bit Float</td> </tr> </table> <p>[Mask] When the data is displayed, “*” will be used to replace all digitals and the color warning function will be cancelled.</p>	Format	16-bit BCD	32-bit BCD	16-bit Hex	32-bit Hex	16-bit Binary	32-bit Binary	16-bit Unsigned	16-bit Signed	32-bit Unsigned	32-bit Signed	32-bit Float
Format													
16-bit BCD													
32-bit BCD													
16-bit Hex													
32-bit Hex													
16-bit Binary													
32-bit Binary													
16-bit Unsigned													
16-bit Signed													
32-bit Unsigned													
32-bit Signed													
32-bit Float													
Number of digits	<p>[Left of decimal Pt.] The number of digits before the decimal point.</p> <p>[Right of decimal Pt.] The number of digits after the decimal point.</p>												
Scaling option	<p>[Do conversion] The data displayed on the screen is the result of processing the raw data from the word address designated by the “Read address.” When the function is selected, it is required to set [Engineering low], [Engineering high], and [Input low] and [Input high] in the “Limitation”. Supposed that “A” represents the raw data and “B” represents the result data, the converting formula is as follows:</p> $B = [\text{Engineering low}] + (A - [\text{Input low}]) \times \text{ratio}$ <p>where, the ratio = $([\text{Engineering high}] - [\text{Engineering low}]) / ([\text{Input high}] - [\text{Input low}])$</p> <p>See the example in the picture below, the raw data is 15, after being</p>												

converted by the above formula as $10 + (15 - 0) \times (50 - 10) / (20 - 0) = 40$, and the result “40” will be displayed on the numeric input object.

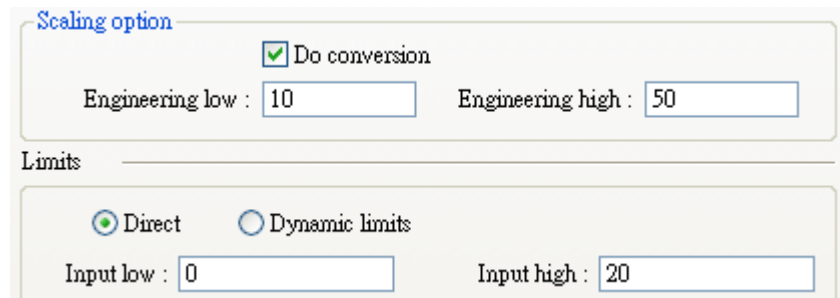

Limits

To set the source of the range for the input data and to set the warning color effect.

[Direct]

The low limit and high limit of the input data can be set in [Input low] and [Input high] respectively. If the input data is out of the defined range, the input value will be ignored.

[Dynamic limits]

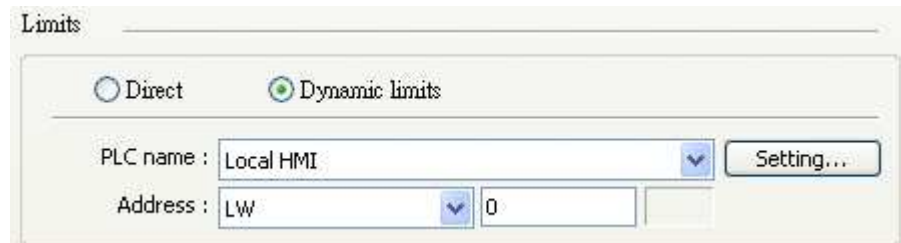

Set the low limit and high limit of the input data to be derived from the designated register. The data length of the designated register is the same as the input object itself. In the above example, the low limit and high limit are derived from [LW100] and the following explains the usage of the low limit and high limit from designated address.

Click [Setting...] to Select the **[PLC name]**, **[Device type]**, **[Address]**, **[System tag]**, **[Index register]** for designated register.

Users can also set address in Numeric Format tab.

Designated address	Input Low Limit	Input High Limit
16-bit format	LW100	LW101 (Address+1)
32-bit format	LW100	LW102 (Address+2)

	<p>[Low limit] When the value of the PLC's register is smaller than [Low limit], the value is displayed with pre-defined color.</p>
	<p>[High limit] When the value of the PLC's register is larger than [High limit], the value is displayed with pre-defined color..</p>
	<p>[Blink] When the value of the PLC's register is smaller than [Low limit] or larger than [High limit], the object will display data with Blinking. The picture below shows the [Font] tab, available in both of the numeric input object and the numeric display object to set font, font size, color, and aligning mode.</p>

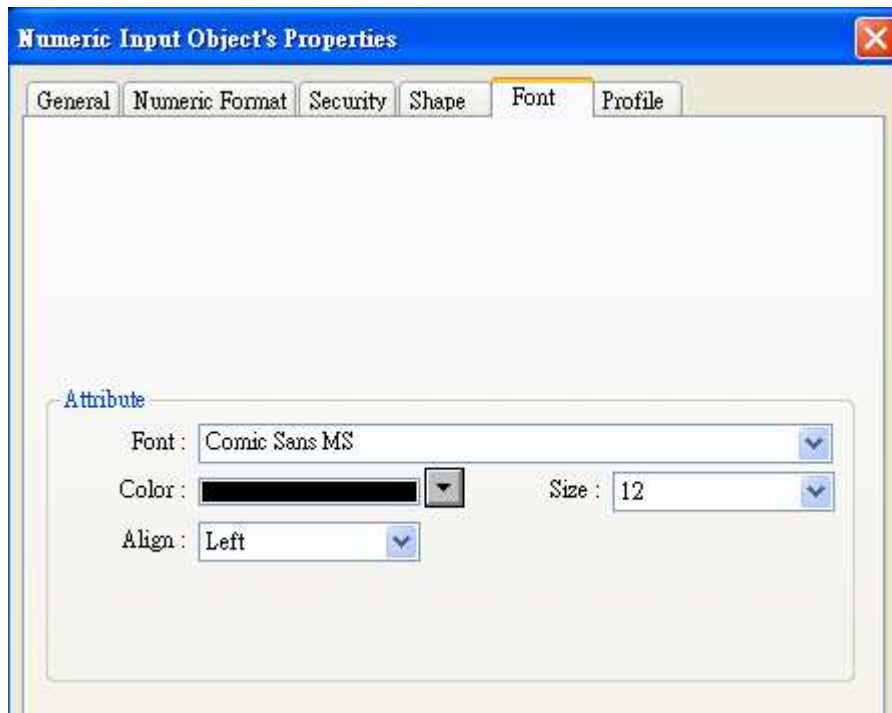

Setting	Description
Attribute	<p>[Color] When the data is within high and low limit, it will be displayed with this color.</p>
	<p>[Align] There are three aligning modes: "Left", "Leading zero", and "Right". The picture below shows the style of each mode.</p>

	<p><i>Left</i> <input type="text" value="12"/></p> <p><i>Leading zero</i> <input type="text" value="0012"/></p> <p><i>Right</i> <input type="text" value="12"/></p>
	<p>[Size] Set font size.</p>

13.10 ASCII Input and ASCII Display

Overview

Both of the ASCII Input object and the ASCII Display object can display the value of the designated word devices in ASCII format. The ASCII input object can also accept the data input from the keypad and change the value of the word devices.

Configuration

Click the “ASCII Input” or “ASCII Display” icon on the toolbar and the “New ASCII Input Object” or “New ASCII Display Object” dialogue box will appear, fill in each item, press OK button, a new “ASCII Input Object” or “ASCII Display Object” will be created. See the pictures below.

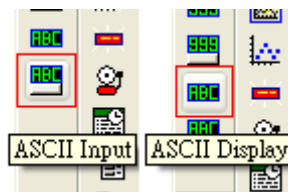

The difference between the “New ASCII Display Object” and “New ASCII Input Object” dialogue boxes is that the latter has the settings for “Notification” and keypad input while the former doesn’t have. The picture below shows the [General] tab of the “New ASCII Input Object”.

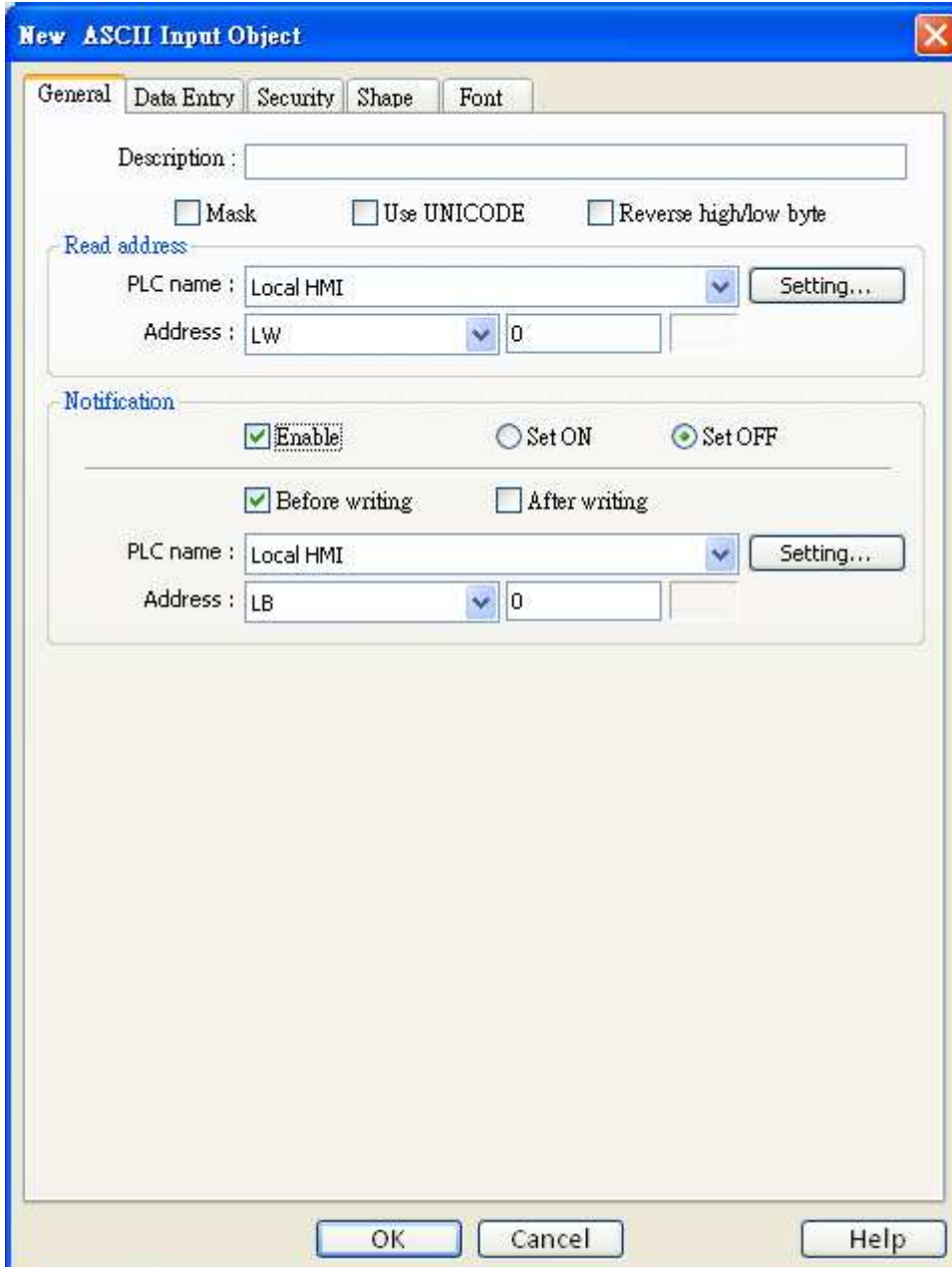

New ASCII Input Object

General | Data Entry | Security | Shape | Font

Description : _____

Mask Use UNICODE Reverse high/low byte

Read address

PLC name : Local HMI [v] [Setting...]

Address : LW [v] 0

Notification

Enable Set ON Set OFF

Before writing After writing

PLC name : Local HMI [v] [Setting...]

Address : LB [v] 0

OK Cancel Help

Setting	Description
[Mask]	When the data is displayed, “*” will be used to replace all texts.
[Use UNICODE]	Click “Use UNICODE” to display data in UNICODE format. Otherwise the system displays the character in ASCII format. This feature can be used with function key [UNICODE]. Not every Unicode has corresponding font stored in the system. The font of UNICODE is only available for those Unicode character that registered function key.
[Reverse high/low byte]	In normal condition, the ASCII code is displayed in “low byte”, “high byte” order. The reverse selection makes the system display ASCII characters in

	<p>“high byte”, “low byte” order.</p>
Read address	<p>Click [Setting...] to Select the [PLC name], [Device type], [Address], [System tag], [Index register] of the word device that system display its value and write new data to it.</p> <p>Users can also set address in General tab while adding a new object.</p>
	<p>[No. of words]</p> <p>To set the length of ASCII data in the unit of words. Each ASCII character take one byte, each word contains two ASCII characters.</p> <p>In the example shown below, the object will display $3 * 2 = 6$ characters.</p> <div style="text-align: center;">  </div>
Notification	<p>When this function is selected, the state of the designated bit device will be set to [ON] or [OFF] after/before the value of the register is changed successfully.</p> <p>Click [Setting...] to Select the [PLC name], [Device type], [Address], [System tag], [Index register] of the Notification bit that system set value to.</p> <p>Users can also set the address in the Notification area.</p>
	<p>[Before writing] / [After writing]</p> <p>Set the state of the designated bit device before or after update the word device.</p>

About the Data Entry tab, please refer to “Numeric Input and Numeric Display” section.



Setting	Description
Attribute	<p>The picture shows the [Font] tab of the ASCII Input object and the ASCII display object. Users can set the font, font size, font color, and aligning mode.</p> 

[Align]

There are two aligning modes: "Left" and "Right". The picture below shows how each mode performs.

Left alignment

ab

bde

Right alignment

ab

bde

[Size]

Set font size.

13.11 Indirect Window

Overview

“Indirect Window” object is to define a popup window location (position / size) and a word device. When the content of the word device is written a valid window number, the window will be popup in the predefined location. The popup window will be closed when the value of the word device is reset (0). The system will only take action when the content of word device is changed. (0 → valid window number, nonzero → 0, A → B valid window number).

Configuration

Click the “Indirect Window” icon on the toolbar and the “New Indirect Window Object” dialogue box will appear, fill in each items, click OK button, a new “Indirect Window Object” will be created. See the pictures below.







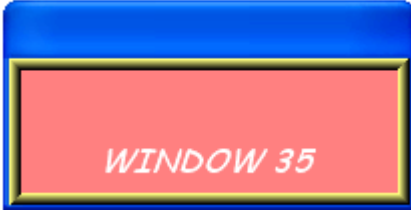

Setting	Description
Read address	Click [Setting...] to Select the [PLC name] , [Device type] , [Address] , [System tag] , [Index register] of the word device that control the window popup. Users can also set address in General tab while adding a new object.
Attribute	[Style] To set the display style of the popup window. There are two styles, "No title bar" and "With title bar".
	a. "No title bar" The popup window does not have title bar, and its position is fix as predefined in configuration.

	
	<p>b. "With title bar" The popup window contains title bar, and its position can be dragged at online operation.</p> 

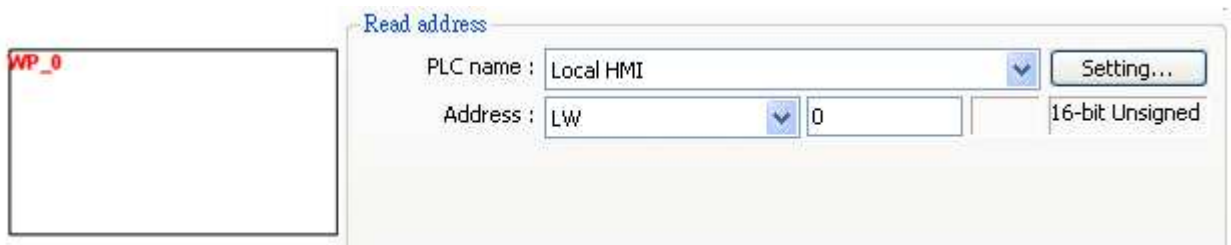
Example to use indirect window

Here is a simple example to illustrate indirect window object. The pictures show how to configure an indirect window and use the word device [LW100] to change the popup window.



-  *Set constant 35 to LW100*
-  *Set constant 36 to LW100*
-  *Set constant 0 to LW100*

```

... 34
+ *35: WINDOW_035
+ *36: WINDOW_036
... 37
... 38
    
```

Use the set word object SW_0 to set the value of [LW100] as 35, and the location of indirect window will display window 35.



Set constant 35 to LW100



Set constant 36 to LW100



Set constant 0 to LW100

Use the set word object SW_1 to set the value of [LW100] as 36, and the location of indirect window will display window 36.



Set constant 35 to LW100



Set constant 36 to LW100



Set constant 0 to LW100

No matter window 35 or 36 is displayed on the indirect window location, press SW_2 to set the value of [LW100] to 0 will close the popup window. The other way to close the popup window from indirect window object is to configure a function key with [close window]. Once you press the function key, the popup window will be closed.

NOTE: Only 16 windows maximum can be displayed simultaneously at run time, and do not use this function to open the window when the same window has been opened by function key or direct window.

13.12 Direct Window

Overview

“Direct window” object is to define a popup window location (position / size), a bit device and a predefined valid window number. When the content of the bit device is set ON/OFF, the window will be popup in the predefined location. The popup window will be closed when the content of the bit device is reset. The system will only take action when the content of bit device is changed (OFF → ON, ON → OFF).

The difference between the “Direct window” and the “Indirect window” is that the direct window object sets the popup window in configuration. When system is in operation, users can use the state of the designated register to control popup or close the window.

Configuration

Click the “Direct Window” icon on the toolbar and the “New Direct Window Object” dialogue box will appear, fill in each items, press OK button, and a new “Direct Window Object” will be created. See the pictures below.



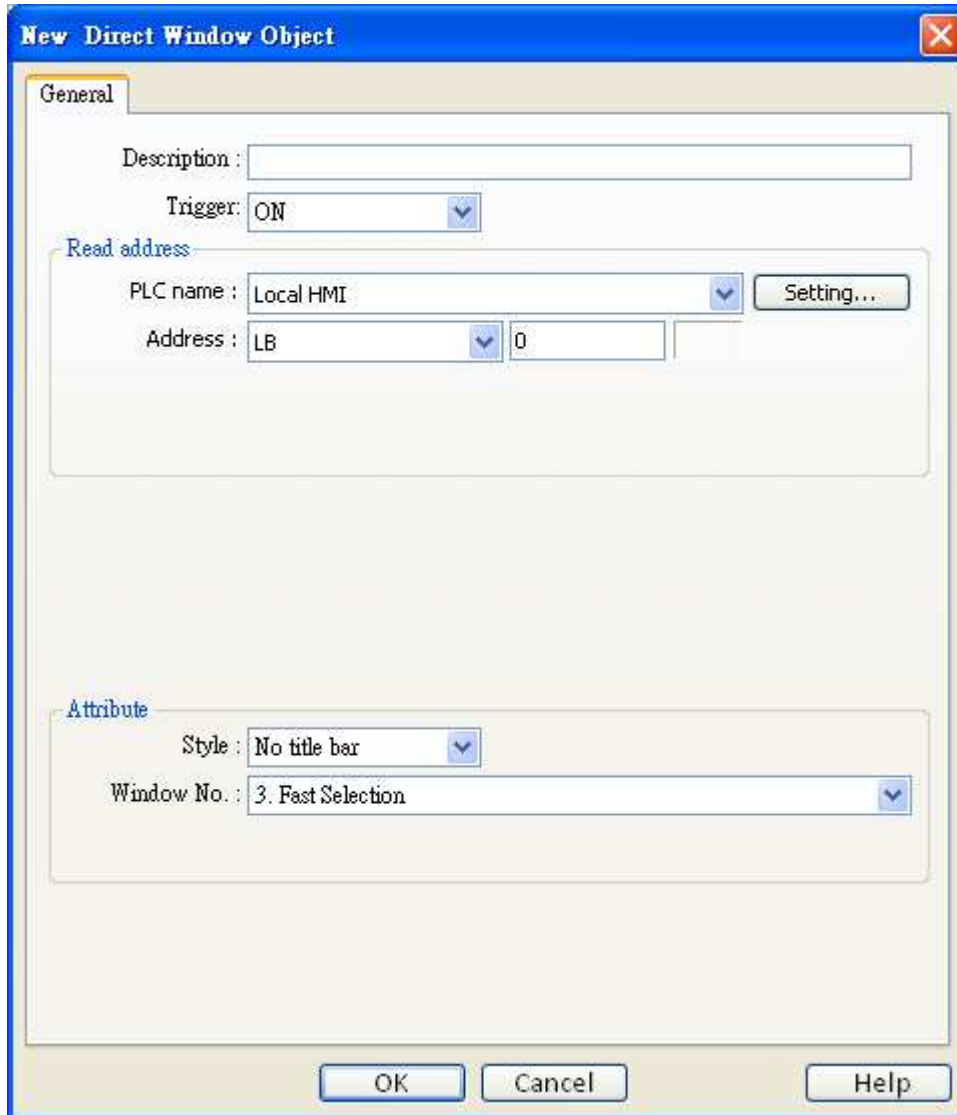

Setting	Description
Read address	Click [Setting...] to Select the [PLC name] , [Device type] , [Address] , [System tag] , [Index register] of the bit device that control the window popup. Users can also set address in General tab while adding a new object.
Attribute	[Style] Refer to the "Indirect Window Object" for related information.
	[Window no.] Set the popup window number.

Example to use direct window

Here is an example to explain how to use the direct window object. The picture below shows the settings of the direct window object. In the example, use [LB10] to call up the window 35.



When the state of LB10 is set to ON, the window 35 will be popup; when the state of LB10 is OFF, the window 35 will be closed. See the picture below.

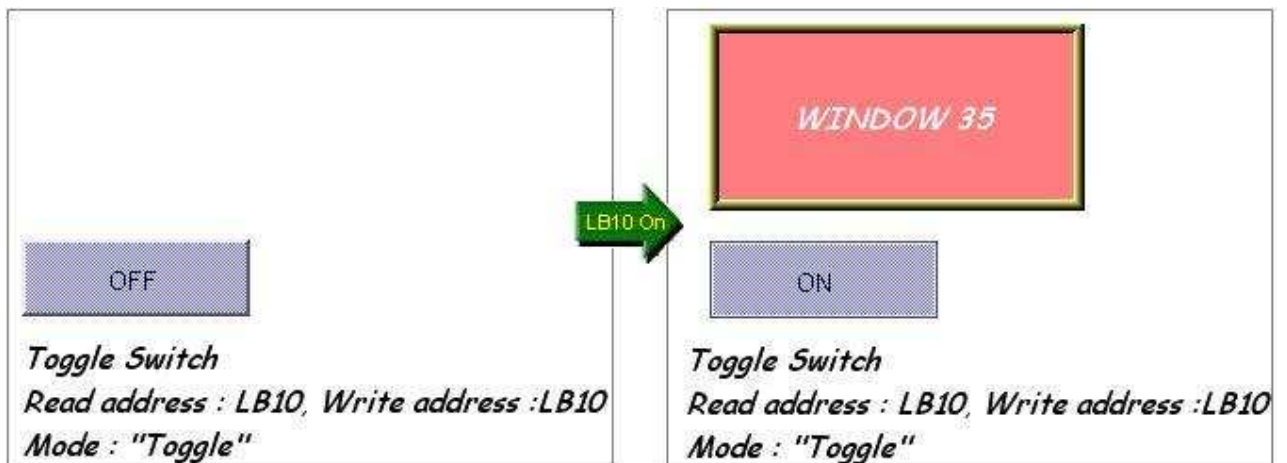

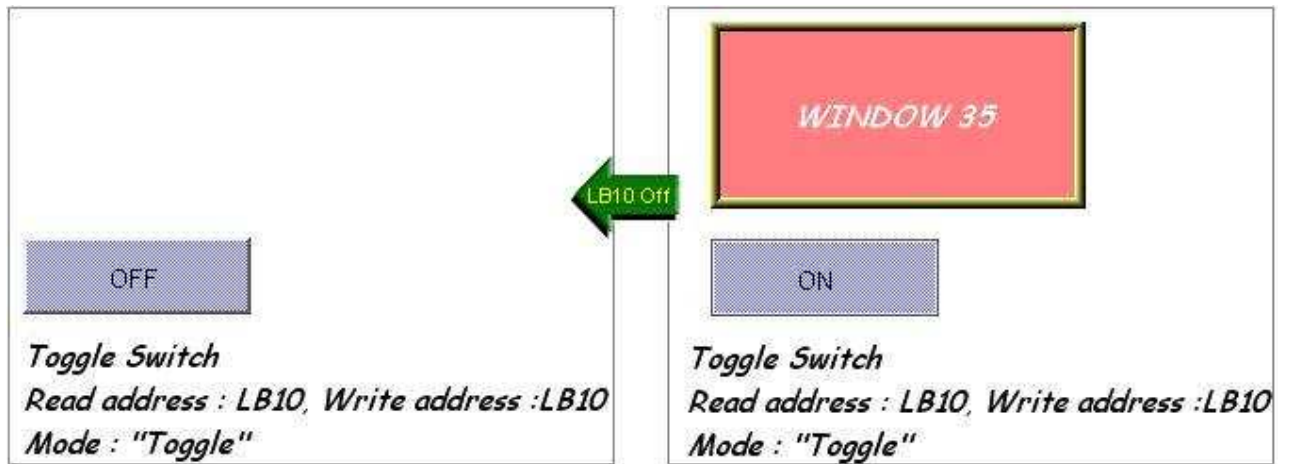

NOTE: Only 16 windows maximum can be displayed simultaneously at run time, and do not use this function to open the window when the same window has been opened by function key or direct window.

13.13 Moving Shape

Overview

Moving Shape object is used to define the object's state and moving distance. The Moving Shape object is used to place an object in a window at a location specified by the PLC. The state and the absolute location of the shape in the window depend on the current values of three continuous PLC registers. Typically, the first register controls the state of the object, the second register controls the horizontal position (X), and the third register controls the vertical position (Y).

Configuration

Click the "Moving Shape" icon on the toolbar and "New Moving Shape Object" dialogue box will appear, fill in each items, press OK button, and a new "Moving Shape Object" will be created. See the pictures below.



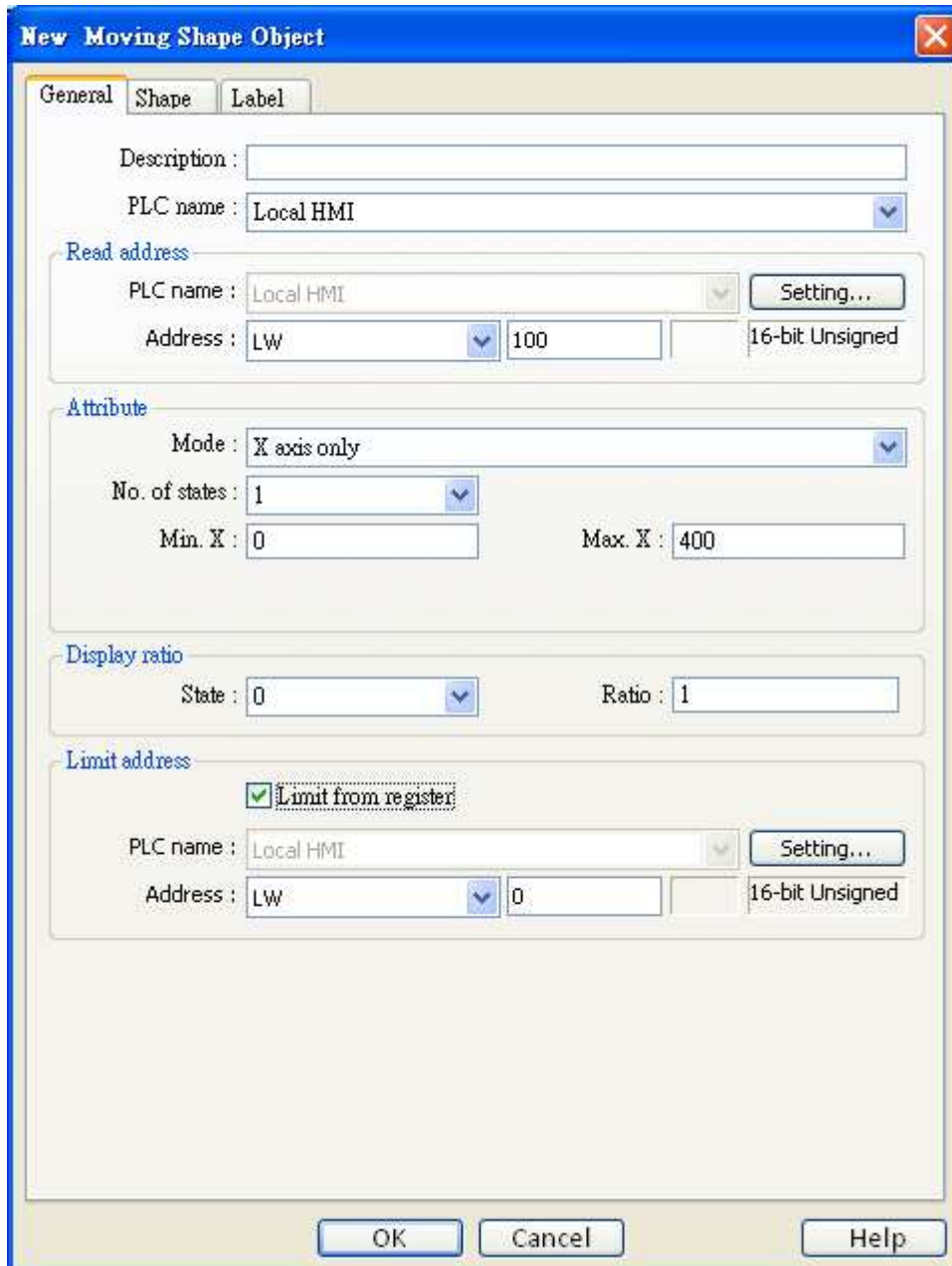

Setting	Description
Read address	<p>Click [Setting...] to Select the [PLC name], [Device type], [Address], [System tag], [Index register] of the word devices that control the display of object's state and moving distance.</p> <p>Users can also set address in General tab while adding a new object.</p> <p>The table below shows the address to control object's state and moving distance in each different data format.</p>

Data format	Address to control object state	Address to control Moving Distance on the X-axis	Address to control Moving distance on the Y-axis
16-bit format	Address	Address + 1	Address + 2
32-bit format	Address	Address + 2	Address + 4

For example, if the object's read address is [LW100] and the data format is "16-bit Unsigned", [LW100] is to control the object's state, [LW101] is to control the object's moving distance on the X-axis, and [LW102] is to control the object's moving distance on the Y-axis.

The picture below shows that the object's read address is [LW100] and initial position is (100, 50). Supposed you want the object moved to the position (160, 180) and be displayed in the shape of State 2, the value of [LW100] must be set to 2, [LW101] = 160–100 = 60, [LW102] = 180–50 = 130.

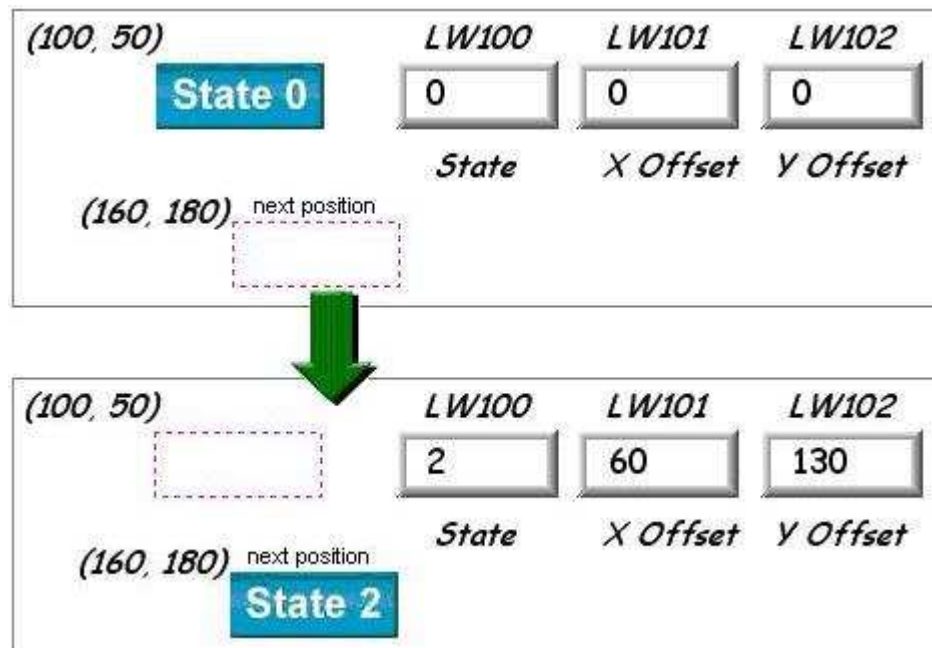

Attribute	To select the object's movement mode and range.
	<p>a. X axis only</p> <p>The object is only allowed to move along the X-axis. The moving range is defined by [Min. X] and [Max. X].</p>

Attribute

Mode : X axis only

No. of states : 8

Min. X : 0 Max. X : 600

Data format	Address to control object state	Address to control Moving Distance on the X-axis
16-bit format	Address	Address + 1
32-bit format	Address	Address + 2

b. Y axis only

The object is only allowed to move along the Y-axis. The moving range is defined by [Min. Y] and [Max. Y].

Attribute

Mode : Y axis only

No. of states : 8

Min. Y : 0 Max. Y : 600

Data format	Address to control object state	Address to control Moving Distance on the Y-axis
16-bit format	Address	Address + 1
32-bit format	Address	Address + 2

c. X & Y axis

The object is allowed to move along the X-axis and Y-axis. The moving range in XY direction is defined by [Min. X], [Max. X] and [Min. Y], [Max. Y] respectively.

Attribute

Mode : X & Y axis

No. of states : 8

Min. X : 0 Max. X : 600

Min. Y : 0 Max. Y : 300

Data format	Address to control object state	Address to control Moving Distance on the X-axis	Address to control Moving distance on the Y-axis
16-bit format	Address	Address + 1	Address + 2
32-bit format	Address	Address + 2	Address + 4

d. X axis w/ scaling

The object is for X axis movement with scale. Supposed that the value of the designated register is DATA, the system uses the following formula to calculate the moving distance on the X-axis.

X axis move distance =
 $(DATA - [\text{Input low}]) * ([\text{Scaling high} - \text{Scaling low}] / ([\text{Input high}] - [\text{input low}]))$

Attribute

Mode : X axis w/ scaling

No. of states : 8

Input low : 0 Input high : 600





Scaling low : 300 Scaling high : 1000

For example, the object is only allowed to move within 0~600, but the range of the register's value is 300~1000, set [Input low] to 300 and [Input high] to 1000, and set [Scaling low] to 0 and [Scaling high] to 600, and the object will move within the range.

Data format	Address to control object state	Address to control Moving Distance on the X-axis
16-bit format	Address	Address + 1
32-bit format	Address	Address + 2

e. Y axis w/ scaling

The object is for Y axis movement with scale, and the formula to calculate the moving distance on the Y-axis is the same as the one in "X axis w/ scaling."

	<table border="1"> <thead> <tr> <th>Data format</th> <th>Address to control object state</th> <th>Address to control Moving Distance on the Y-axis</th> </tr> </thead> <tbody> <tr> <td>16-bit format</td> <td>Address</td> <td>Address + 1</td> </tr> <tr> <td>32-bit format</td> <td>Address</td> <td>Address + 2</td> </tr> </tbody> </table>	Data format	Address to control object state	Address to control Moving Distance on the Y-axis	16-bit format	Address	Address + 1	32-bit format	Address	Address + 2						
Data format	Address to control object state	Address to control Moving Distance on the Y-axis														
16-bit format	Address	Address + 1														
32-bit format	Address	Address + 2														
	<p>f. X axis w/ reverse scaling This function is the same as “X axis w/ scaling”, but the moving direction is in reverse.</p>															
	<p>g. Y axis w/ reverse scaling This function is the same as “Y axis w/ scaling”, but the moving direction is in reverse.</p>															
Display ratio	<p>The size of shape in different states can be set individually as shown in the picture below.</p> <div style="display: flex; justify-content: space-around; align-items: center;"> <div style="text-align: center;"> <p><i>Ratio : 1</i></p>  </div> <div style="text-align: center;"> <p><i>Ratio : 1.2</i></p>  </div> <div style="text-align: center;"> <p><i>Ratio : 1.4</i></p>  </div> <div style="text-align: center;"> <p><i>Ratio : 1.6</i></p>  </div> </div>															
Limit address	<p>The object’s moving range can be set not only by [Min. X], [Max. X] and [Min. Y] [Max. Y], but also by the designated registers. Supposed that the object’s moving range is set by the value of the designated register “Address”, then the address of [Min. X], [Max. X] and [Min. Y] [Max. Y] are listed in the following table.</p> <table border="1"> <thead> <tr> <th>Data format</th> <th>[Min. X] address</th> <th>[Max. X] address</th> <th>[Min. Y] address</th> <th>[Max. Y] address</th> </tr> </thead> <tbody> <tr> <td>16-bit format</td> <td>Address</td> <td>Address + 1</td> <td>Address + 2</td> <td>Address + 3</td> </tr> <tr> <td>32-bit format</td> <td>Address</td> <td>Address + 2</td> <td>Address + 4</td> <td>Address + 6</td> </tr> </tbody> </table>	Data format	[Min. X] address	[Max. X] address	[Min. Y] address	[Max. Y] address	16-bit format	Address	Address + 1	Address + 2	Address + 3	32-bit format	Address	Address + 2	Address + 4	Address + 6
Data format	[Min. X] address	[Max. X] address	[Min. Y] address	[Max. Y] address												
16-bit format	Address	Address + 1	Address + 2	Address + 3												
32-bit format	Address	Address + 2	Address + 4	Address + 6												

13.14 Animation

Overview

The Animation object is used to place an object on the screen at a specified location determined by a predefined path and data in the PLC. The state and the absolute location of the shape on the screen depend on current reading value of two continuous PLC registers. Typically, the first register controls the state of the object and the second register controls the position along the predefined path. As the PLC position register changes value, the shape or picture jumps to the next position along the path.

Configuration

Click the “Animation” icon on the toolbar, move the mouse to each moving position and click the left button to define all moving positions one by one. When settings of all moving positions are completed, click the right button of the mouse, a new animation object will be created. See the pictures below.

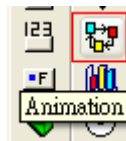

To change the object’s attributes, you can double click the left button of the mouse on the object, and the “Animation Object’s Properties” dialogue box, as shown in the picture below, will appear.

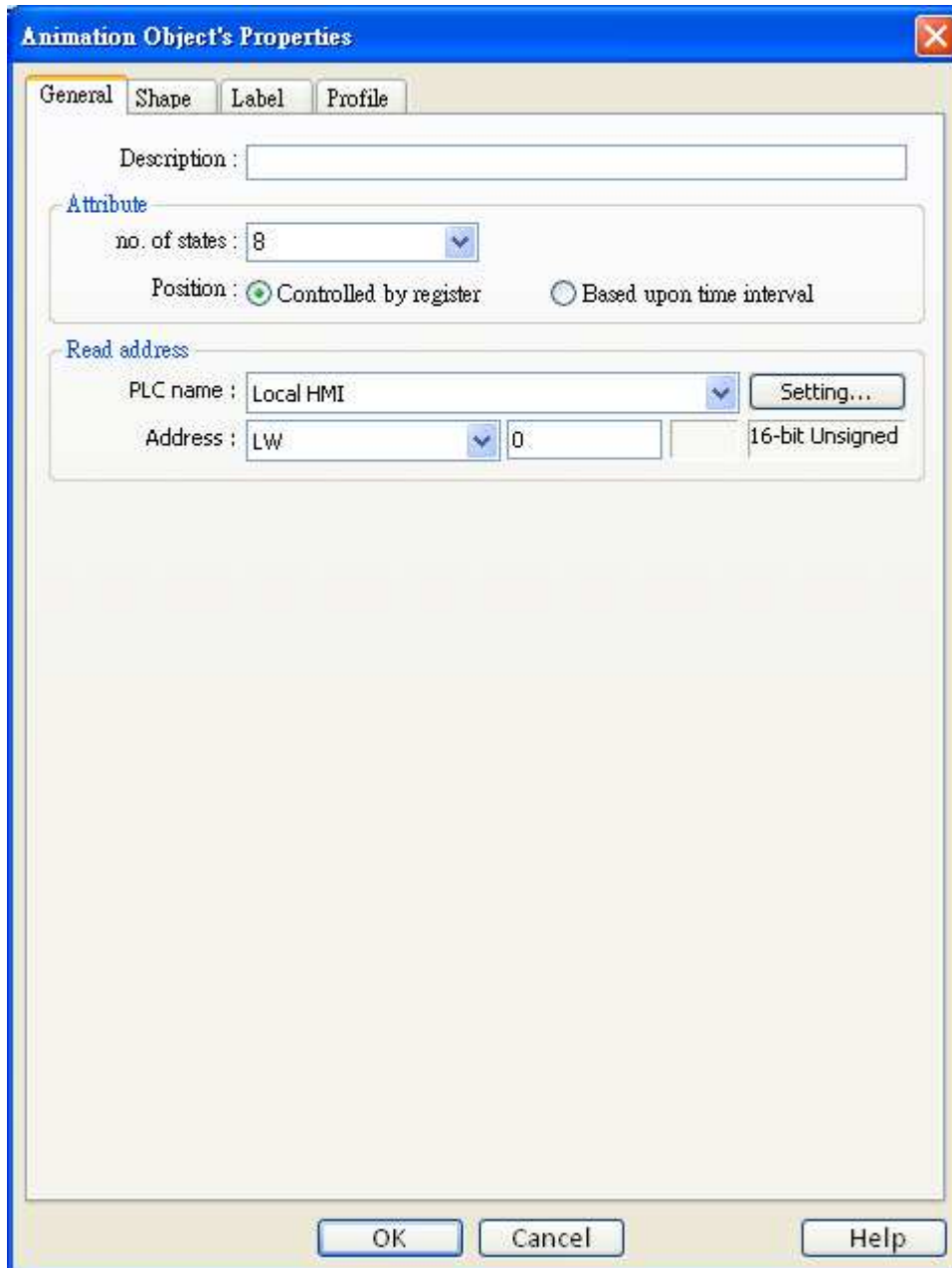

Setting	Description
Attribute	[Total no. of states] To set the number of the states for this object.
a. Controlled by register	When select “Controlled by register”, the designated register controls the object’s state and position. Read address If select “Controlled by register” option, it is necessary to set the read address. Click [Setting...] to Select the [PLC name] , [Device type] , [Address] , [System tag] , [Index register] for the read

address.

Users can also set address in General tab while adding a new object.

In the table below, it describes the address that control shape's state and position in different data format.

Data Format	Address to control object's state	Address to control object's position
16-bit format	Address	Address + 1
32-bit format	Address	Address + 2

For example, if the designated register is [LW100] and the data format is "16-bit Unsigned", then [LW100] represents object's state, [LW101] represents position. In the picture below, [LW100] = 2, [LW101] = 3, so the object's state is 2 and position is 3.

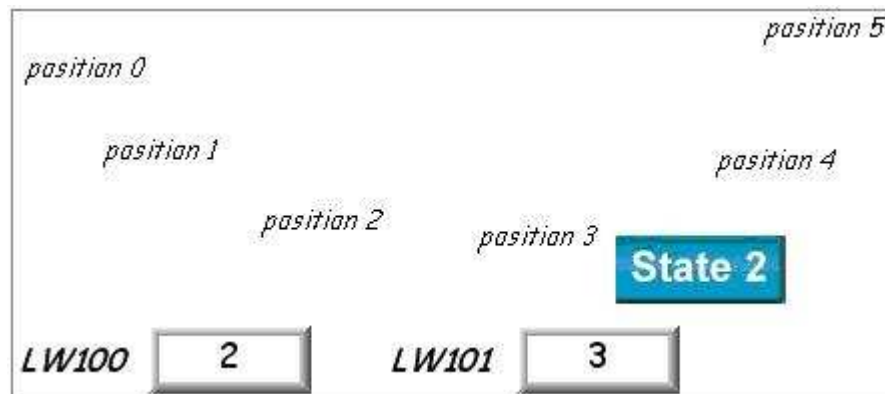
b. Based upon time interval

If "Based upon time interval" is chosen, the object automatically changes status and display location. "Time interval attributes" is to set the time interval for states and positions.

Time interval attributes

Position speed : * 0.1 second(s)

Image state change : Backward cycle

Image update time : * 0.1 second(s)

[Position speed]

Position changes speed, the unit is 0.1 second. Supposed that [Speed] is set to 10, the object will change its position every 1

second.

[Backward cycle]

If the object has four positions: position 0, position 1, position 2, and position 3, and [Backward cycle] is not selected. In this case when the object moves to the last position (position 3), next position will be back to the initial position 0, and repeat the action over again. The moving path is shown as follows:

position 0 → position 1 → position 2 → position 3 → position 0
→ position 1 → position 2...

If [Backward cycle] is selected, when the object moves to the last position (position 3), it will move backwards to the initial position 0, and repeat the moving mode over again. The moving path is shown as follows.

position 0 → position 1 → position 2 → position 3 → position 2
→ position 1 → position 0...

[Image state change]

State change mode. There are “Position dependant” and “Time-based” options. When “Position dependant” is selected, it means that following the change of position, the state will change too. When “Time-based” is selected, it means that the position will change based on “Position speed” and shape state will change based on “Image update time”

Time interval attributes

Position speed : * 0.1 second(s)

Image state change : Backward cycle

Position-dependant
Time-based

The following dialog shows size setup of animation object. Call up the animation object dialogue box by double clicking.

The screenshot shows the 'Animation Object's Properties' dialog box with the 'Profile' tab selected. The dialog has four sections: 'Position', 'Size', 'Shape rectangle size', and 'Trajectory'. The 'Position' section includes a 'Pinned' checkbox and X/Y coordinates (191, 122). The 'Size' section includes Width (414) and Height (144). The 'Shape rectangle size' section includes Width (84) and Height (33). The 'Trajectory' section includes a dropdown menu set to 'Position 0' and X/Y coordinates (191, 147). At the bottom are 'OK', 'Cancel', and 'Help' buttons.

Section	Property	Value
Position	X	191
	Y	122
Size	Width	414
	Height	144
Shape rectangle size	Width	84
	Height	33
Trajectory	X	191
	Y	147

Setting	Description
Shape rectangle size	To set the size of the shape.
Trajectory	To set the position of each point on the moving path.

13.15 Bar Graph

Overview

Bar graph object displays PLC register data as a bar graph in proportion to its value.

Configuration

Click the “Bar Graph” icon on the toolbar, the “Bar Graph” dialogue box will be shown up, fill in each items of settings, click OK button, a new “Bar Graph Object” will be created. See the picture below.

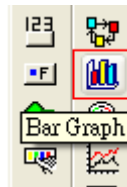

The following picture shows the “General” tab of the bar graph object.

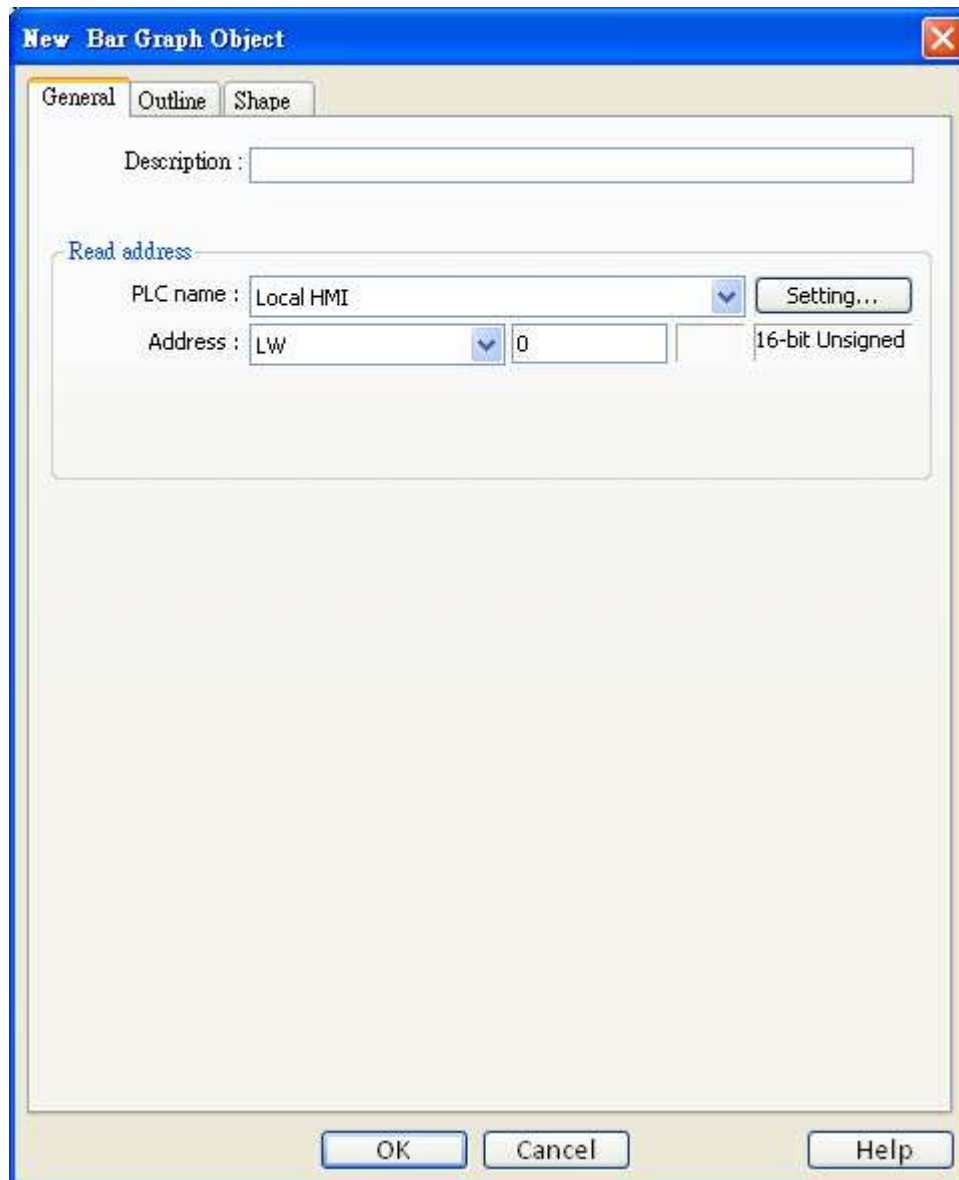

Read address

Click [Setting...] to Select the **[PLC name]**, **[Device type]**, **[Address]**, **[System tag]**, **[Index register]** of the word devices that controls the bar graph display.

Users can also set address in General tab while adding a new object.

The following picture shows the "Outline" tab of the bar graph object.

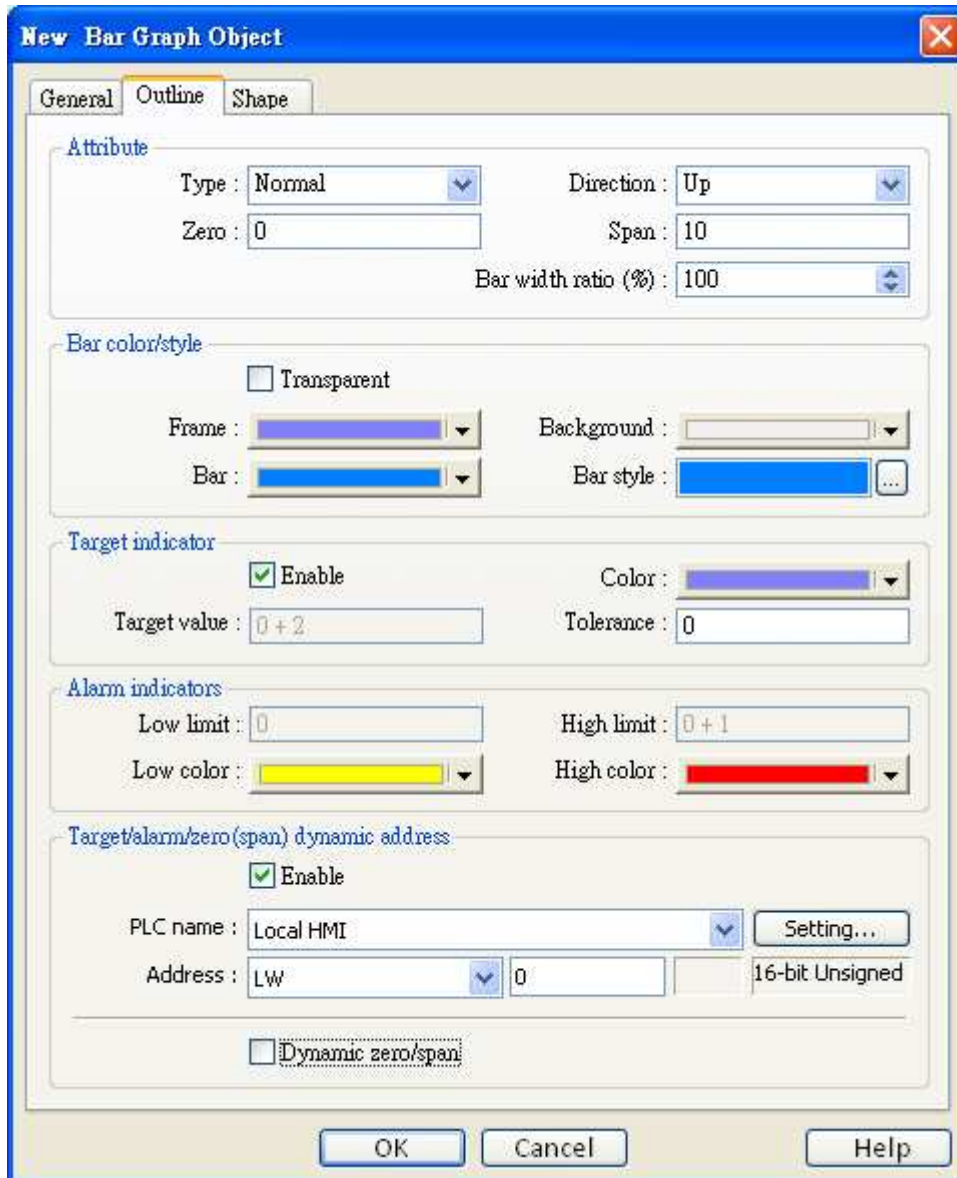

Setting	Description
---------	-------------

Attribute**[Type]**

There are "Normal" and "Offset" for selection. When select "Offset", there must be a original value for reference. Please refer the illustration below.

Attribute

Type :	<input type="text" value="Offset"/>	Direction :	<input type="text" value="Up"/>
Zero :	<input type="text" value="0"/>	Span :	<input type="text" value="10"/>
Origin :	<input type="text" value="5"/>	Bar width ratio (%) :	<input type="text" value="100"/>

[Direction]

To select the bar graph direction, and there are "Up", "Down", "Right", and "Left" for selection.

[Zero]、 [Span]

The filled bar percentage can be calculated with the following formula:

The filled bar percentage = (Register value – Zero) / [Span] – [Zero] * 100%

When select "Offset", if (Register value – Zero) > 0, the bar will fill up from origin setting; if (Register value – Zero) < 0, the bar will fill up but down side from origin setting.

For example,

Origin =5, Span=10, Zero=0 and use different value in read address, it will display as illustration below.

When read address value is 4,

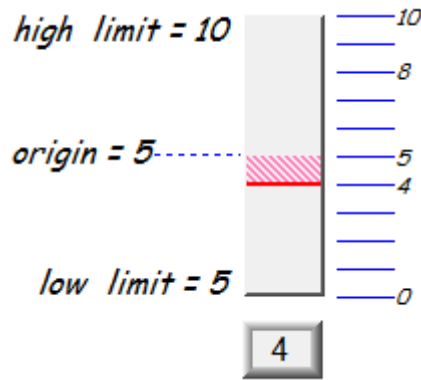

When read address value is 8,

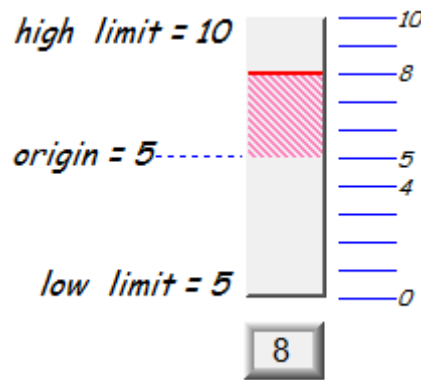

[Bar width ratio(%)]

To display the ratio between bar and object width. Below illustration displays two ratio, 50% and 100%.

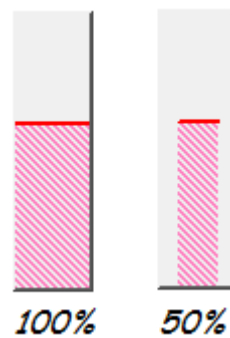

Bar color/style

To set the bar's Frame, Background color, Bar style, and Bar color. See the picture below.

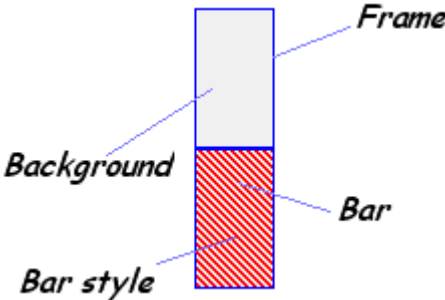
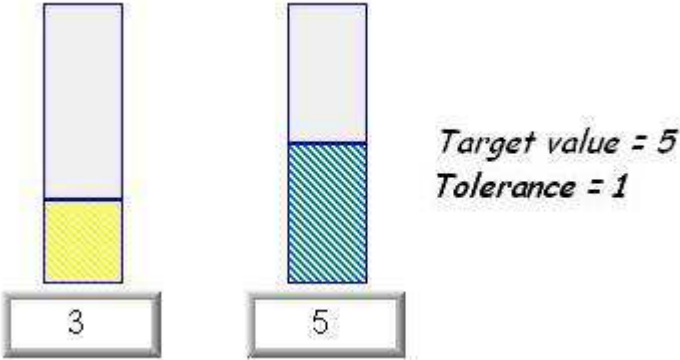
	 <p>The diagram shows a vertical bar indicator. It consists of a top section labeled 'Frame' (light gray), a middle section labeled 'Background' (white), and a bottom section labeled 'Bar' (red with diagonal hatching). A label 'Bar style' points to the hatching pattern.</p>
<p>Target Indicator</p>	<p>When the register value meets the following condition, the color of filled area will change to the “Target color”</p> <p>Click [Setting...] to Select the [PLC name], [Device type], [Address], [System tag], [Index register] of dynamic address.</p> <p>Users can also set address in Outline tab while adding a dynamic address.</p> <p>$[Target\ Value] - [Tolerance] \leq Register\ value \leq [Target\ Value] + [Tolerance]$</p> <p>See the picture below, in here [Target Value] = 5, [Tolerance] = 1, if the register value is equal to or larger than $5-1=4$ and equal to or less than $5+1=6$, the filled area’s color of the bar will change to the “Target color”</p>  <p>The diagram shows two bar indicators. The first bar has a value of 3 and a yellow filled area. The second bar has a value of 5 and a blue hatched filled area. Text to the right indicates 'Target value = 5' and 'Tolerance = 1'.</p>
<p>Alarm Indicator</p>	<p>When register’s value is larger than [High limit], the color of filled area will change to [High color], when register’s value is smaller than [Low limit], the color of filled area will change to [Low color].</p>

Target/Alarm Dynamic Address

When select [Enable], the [Low limit] and [High limit] of “Alarm indicator” and the [Target Value] of “Target indicator” all come from designated register. See the picture below.

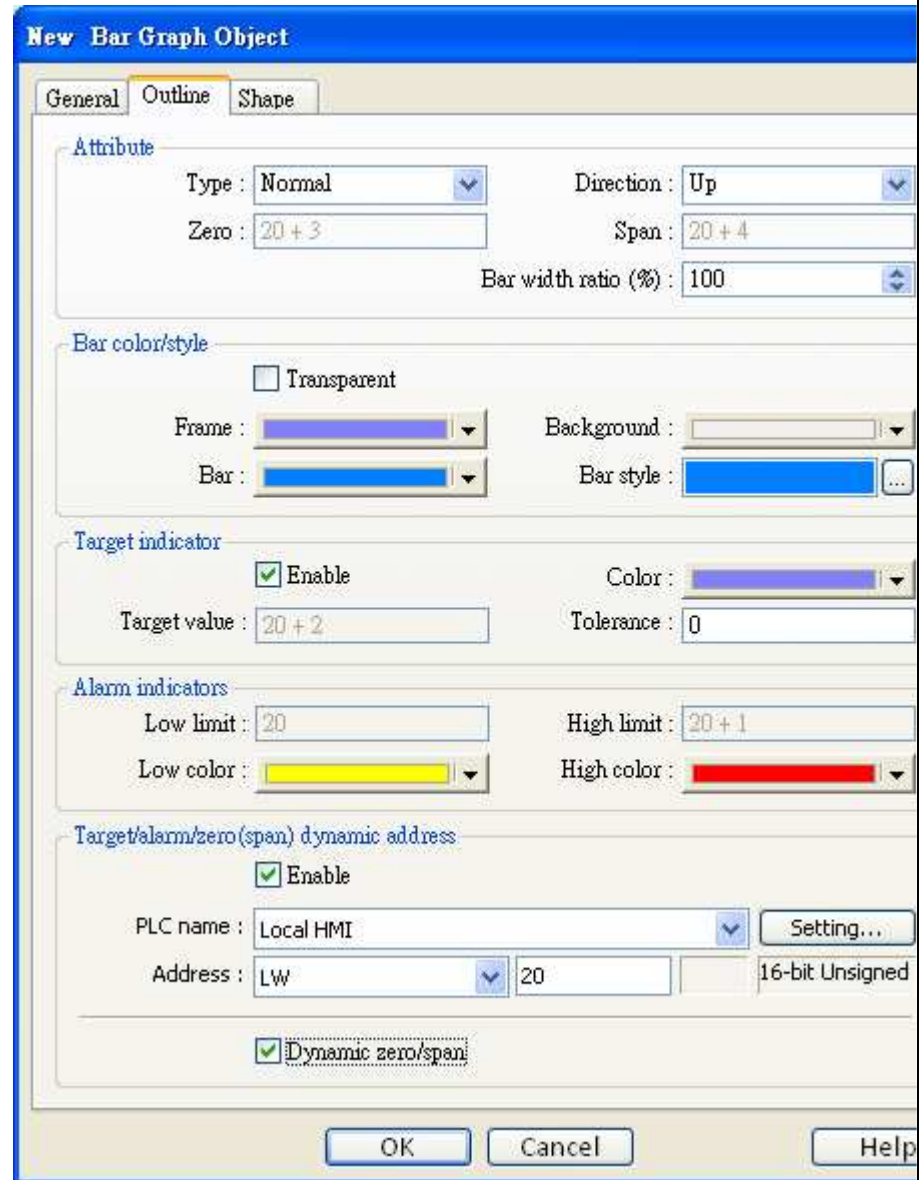

The following table shows the read address of low limit, high limit, and target. The “Address” means the device address, for example, if the device address is [LW20] and data format is 16-bit,

The Alarm Low limit is LW 20 / The Alarm High limit is LW21

The Target indicator is LW22 / The Zero is LW23 / The Span is LW24

Data Format	Alarm Low limit	Alarm High limit	Target indicator	Zero	Span
16-bit format	Addresses	Addresses + 1	Address + 2	Addresses + 3	Addresses + 4
32-bit format	Addresses	Addresses + 2	Address + 4	Addresses + 6	Addresses + 8

13.16 Meter Display

Overview

The meter display object can display the value of word device with meter.

Configuration

Click the “Meter Display” icon on the toolbar and the “Meter Display Object’s Properties” dialogue box will appear, fill in each items, press OK button, and a new “Meter Display Object” will be created. See the picture below.

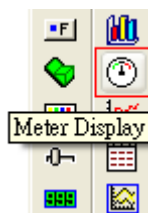

The picture below shows the “General” tab in the “Meter Display Object’s Properties” dialogue box.

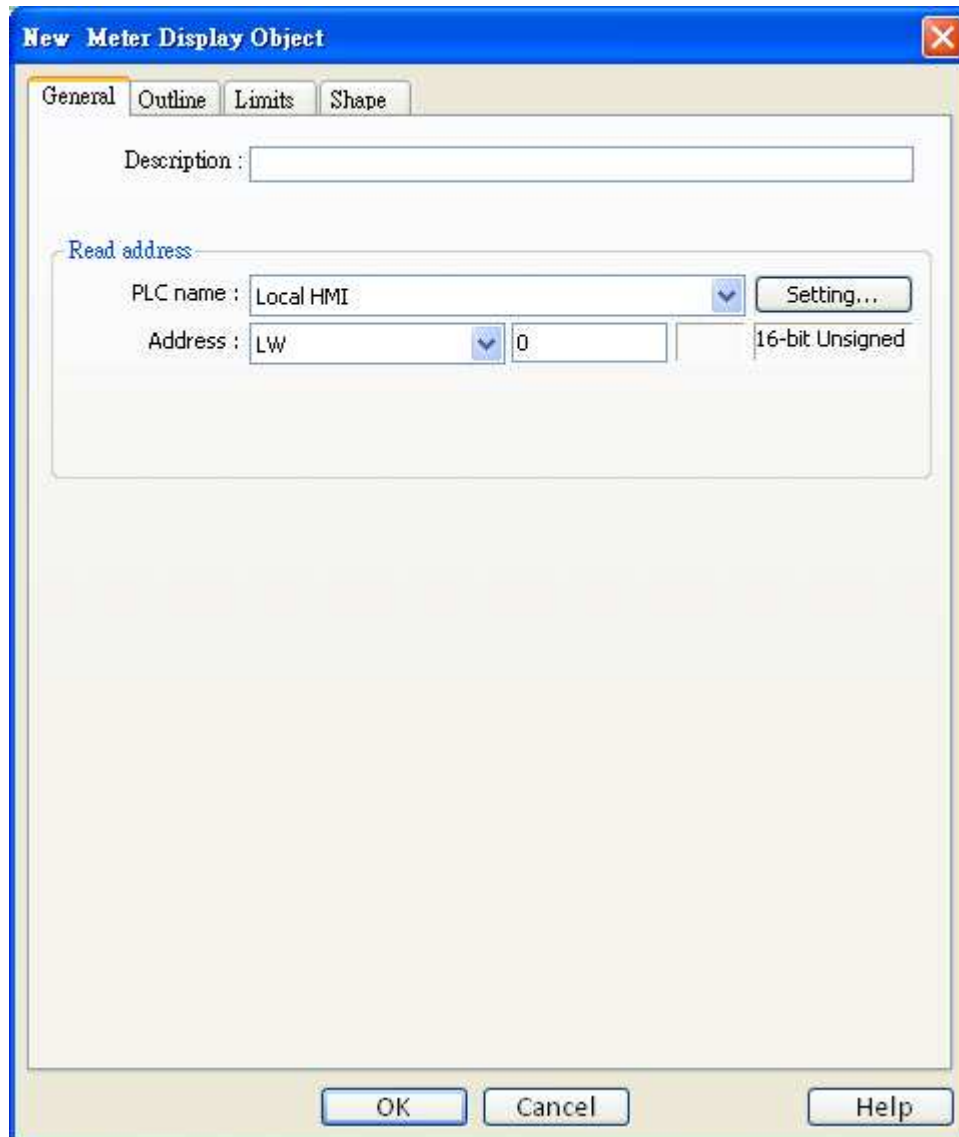

Read address

Click [Setting...] to Select the **[PLC name]**, **[Device type]**, **[Address]**, **[System tag]**, **[Index register]** of the word devices that controls the display of meter.

Users can also set address in General tab while adding a new object.

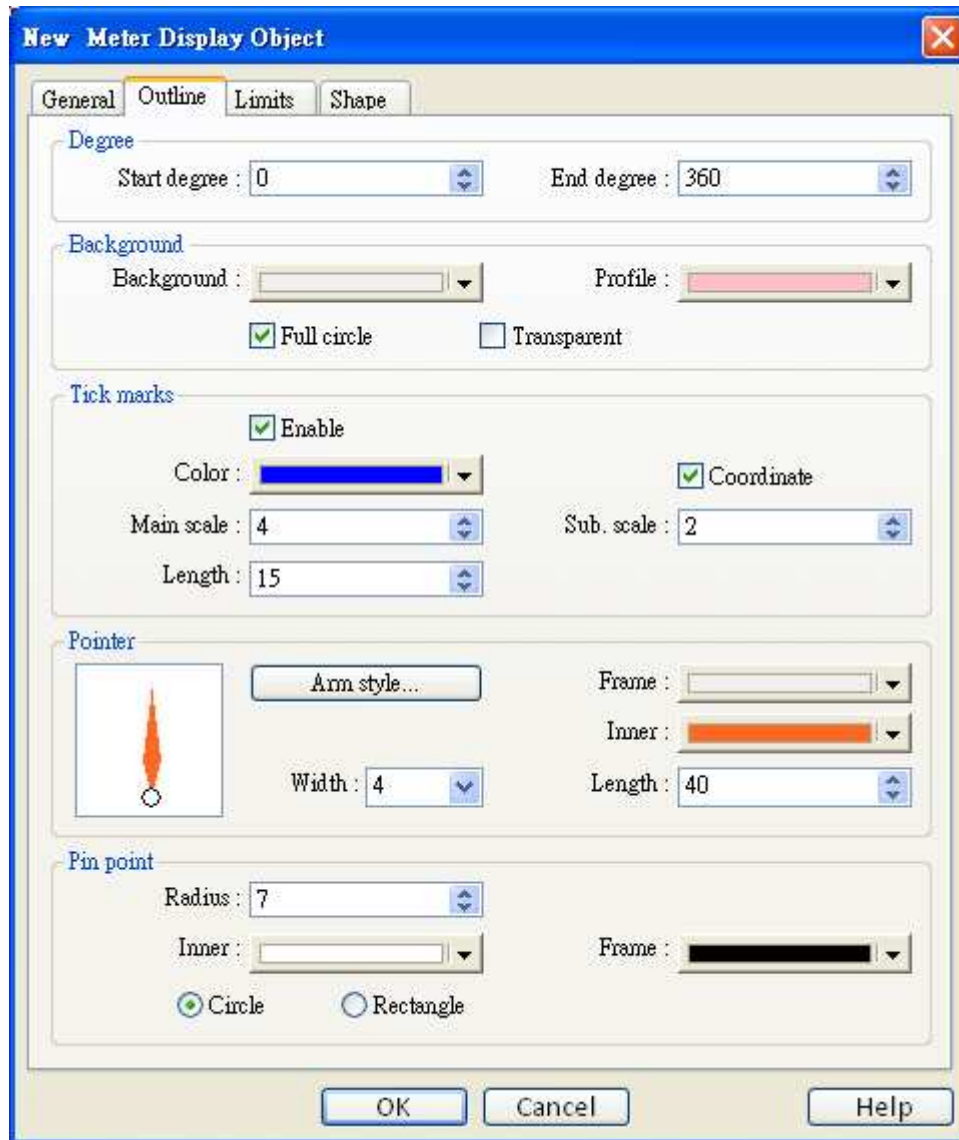

In the above dialogue box, users can set the meter display object's outline. Refer to the picture below for the names of each part of the meter.

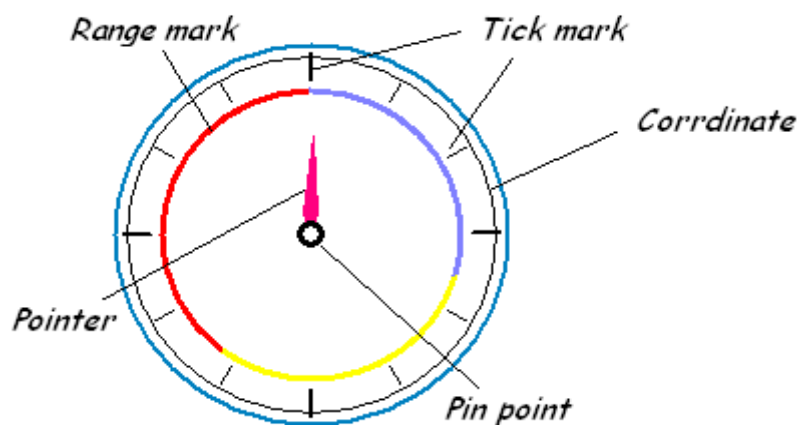

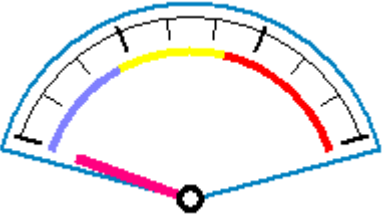
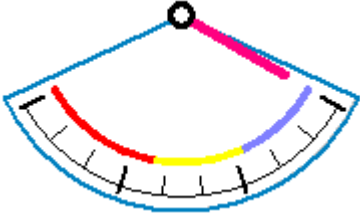
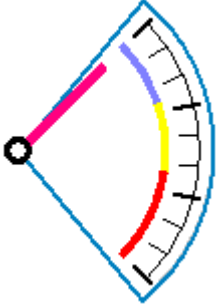
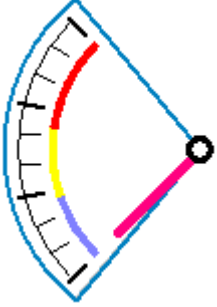
Setting	Description
Degree	<p>Set the object's "start degree" and "end degree", the angle range is 0-360 degrees. The following pictures show several results of different settings.</p> <div style="text-align: center;">  <p>[Start degree] = 290, [End degree] = 70</p>  <p>[Start degree] = 120, [End degree] = 240</p>  <p>[Start degree] = 40, [End degree] = 140</p>  <p>[Start degree] = 225, [End degree] = 315</p> </div>
Background	<p>Set the object's background color and profile color.</p> <p>[Full circle] When the "Full circle" is selected, the object will display the</p>

whole circle, otherwise the object will display the defined degree range. See the picture below.

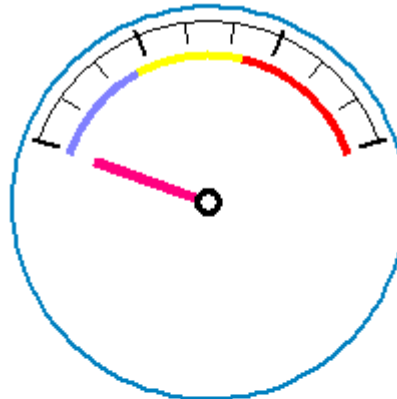

Full circle

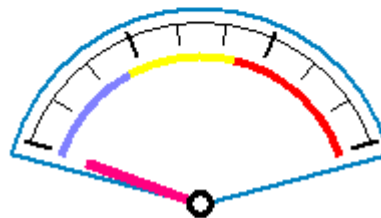

non-full circle

[Transparent]

When the “Transparent” is selected, the object will not display the background and profile color. See the picture below.

Tick marks	To set the tick mark’s number and color.
Pointer	To set Pointer’s style, length, width, and color.
Pin point	To set pin point’s style, radius, and color

The following pictures show the “Limit” tab and the sign of low and high limit set in the “Limit” tab.

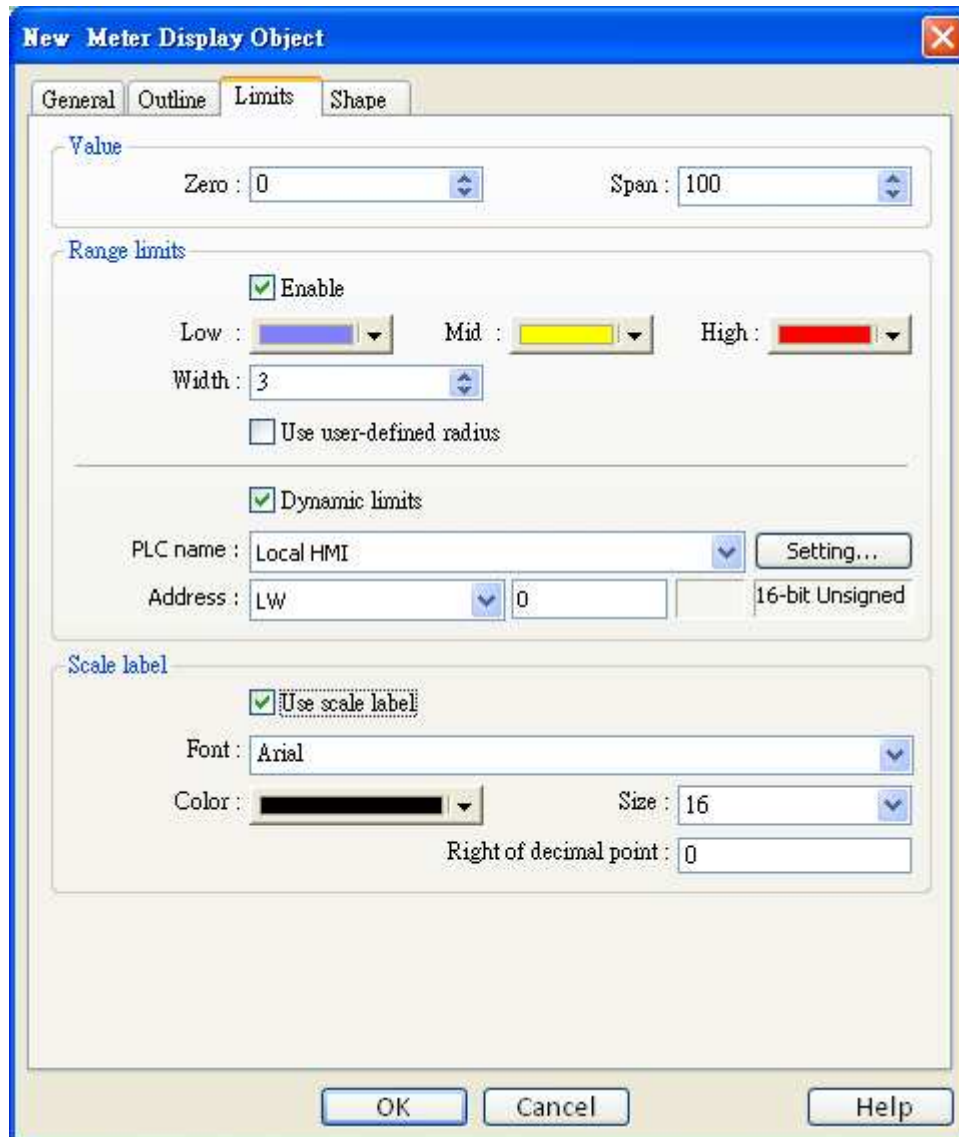

Setting	Description
Value	<p>To set object's display range. Meter display object will use the value of [Zero] and [Span] and the value of register to calculate the pointer's indication position. For example, supposed that [Zero] = 0, [Span] = 100, when the value of register is 30 and [Start degree] = 0, [End degree] = 360, then the degree indicated by pointer is:</p> $\{(30 - [\text{Zero}]) / ([\text{Span}] - [\text{Zero}])\} * ([[\text{End degree}] - [\text{Start degree}]] =$ $\{(30 - 0) / (100 - 0)\} * (360 - 0) = 108$ <p>Pointer will indicate the position of 108 degrees. See the picture below.</p>

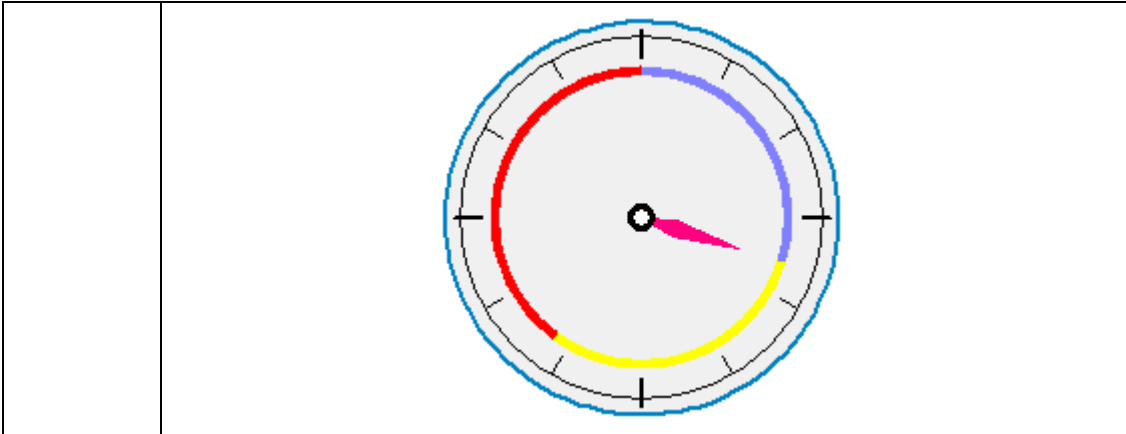

Range limit

To set the value of low and high limit, the display color, width of the sign of low, high limit.

Below illustration use above setting to display the range mark.

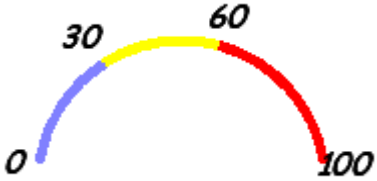

[user-defined radius]

Range limits

Enable

Low : Mid : High :

Width : 10

Use user-defined radius 80

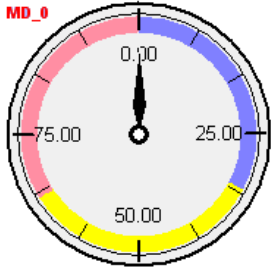

Range limits

Enable

Low : Mid : High :

Width : 10

Use user-defined radius 30

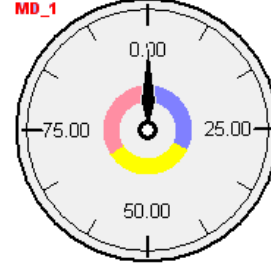

[Dynamic Limits] / unchecked

When “Dynamic limits” is not selected, the low limit and high limit are fixed value, which directly comes from the settings. See the example below, the low limit is 30 and high limit is 60.

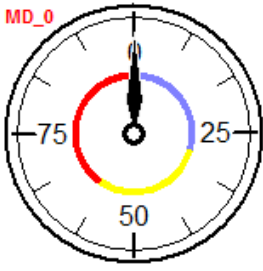
	<div style="text-align: center;"> <input type="checkbox"/> Dynamic limits Low limit <input type="text" value="30"/> High limit <input type="text" value="60"/> </div>									
<p>[Dynamic Limits] / check</p>	<p>When Dynamic limits is selected, the low limit and high limit are decided by the register.</p> <p>Click [Setting...] to Select the [PLC name], [Device type], [Address], [System tag], [Index register] for Dynamic limits. Users can also set address in Limits tab while adding a new object.</p> <p>Please refer to the following dialog.</p> <div style="text-align: center;"> <input checked="" type="checkbox"/> Dynamic limits PLC name : <input type="text" value="Local HMI"/> <input type="button" value="Setting..."/> Address : <input type="text" value="LW"/> <input type="text" value="0"/> <input type="text" value="16-bit Unsigned"/> </div> <p>There following table shows the read address of low limit and high limit. The "Address" means the register's address. If the register is [LW100], the "Address" is 100.</p> <table border="1" style="width: 100%; text-align: center;"> <thead> <tr> <th>Data format</th> <th>Low limit's read address</th> <th>High limit's read address</th> </tr> </thead> <tbody> <tr> <td>16-bit format</td> <td>Address</td> <td>Address + 1</td> </tr> <tr> <td>32-bit format</td> <td>Address</td> <td>Address + 2</td> </tr> </tbody> </table>	Data format	Low limit's read address	High limit's read address	16-bit format	Address	Address + 1	32-bit format	Address	Address + 2
Data format	Low limit's read address	High limit's read address								
16-bit format	Address	Address + 1								
32-bit format	Address	Address + 2								
<p>Scale label</p>	<p>To select the attribute of scale label on meter display.</p> <div style="display: flex; align-items: center;"> <div style="margin-right: 20px;"> <p>MD_0</p>  </div> <div> <p>Scale label</p> <input checked="" type="checkbox"/> Use scale label Font : Arial Color : <input type="text" value="Black"/> Size : <input type="text" value="12"/> No. of decimal : <input type="text" value="0"/> </div> </div>									

13.17 Trend Display

Overview

Trend display object can use the curve to represent the data recorded by data sampling object. The sampling operation is conducted by data sampling objects. The trend display object display the result of sampling. The following picture shows an example of trend display object.

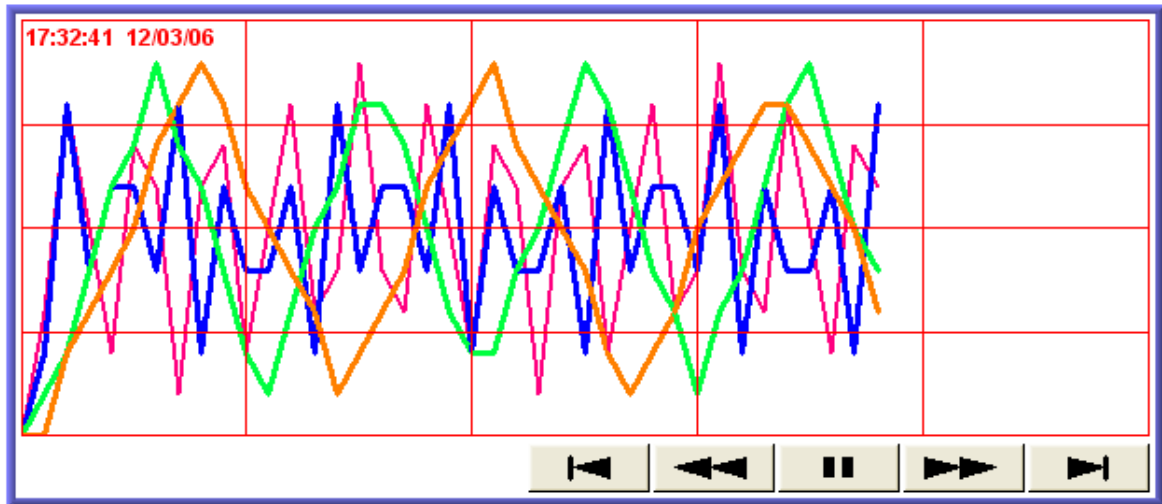

Configuration

Click the “Trend Display” icon on the toolbar and the “Trend Display Object’s Properties” dialogue box will appear, fill in each items, press the OK button and a new “Trend Display Object” will be created. See the picture below.

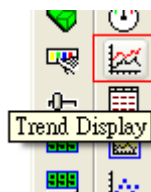

The following picture shows the “General” tab in the “Trend Display Object’s Properties” dialogue box.

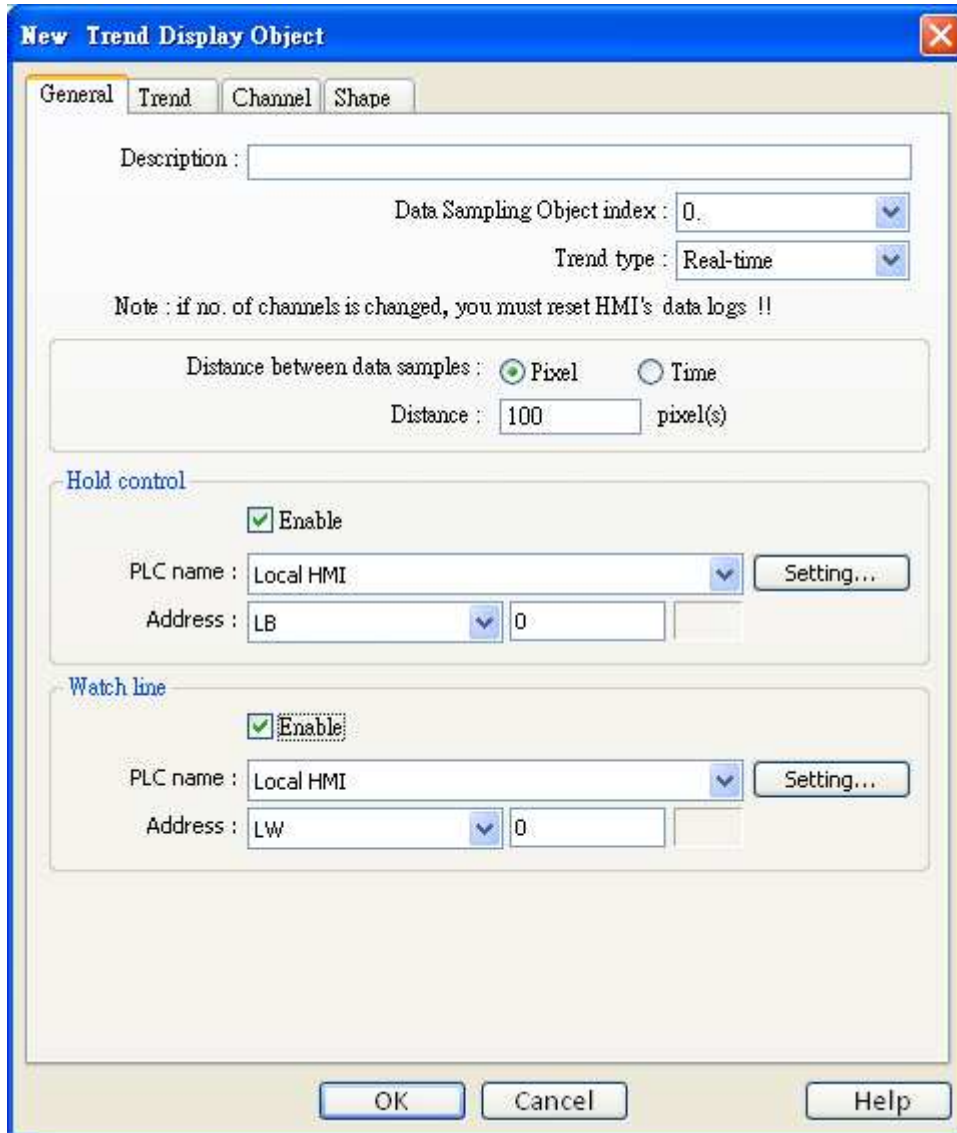

Setting	Description
[Data Sampling Object index]	To select data sampling object as the source of data. Refer to the “data sampling” section for related information.
[Trend mode]	<p>To select the mode of data source. There are “Real-time” and “History” for selection.</p> <p>a. Real-time</p> <p>In this mode, it can display the sampling data from the beginning of the MT8000 operation to the present time. If previous data are required, you must select the “History” mode to read the data from historical record.</p> <p>You can use the “Hold control” object to pause the update of trend</p>

display, but it is only pause the update of the trend display, and it will not stop the operation of data sampling object. The picture below shows the “Hold control” setting page. Set the state of the designated register to ON, it will pause the updating of the trend display.

b. History

In this mode, the data come from the historical record of the designated data sampling object in [Data sampling object index]. Data sampling object will use the sampling data which was sorted in according to dates. The system use “History control” to select the historical records that are created by the same data sampling object. The picture below shows the “History control” setting page.

The system sorts the historical records of sampling data by date; the latest file is record 0 (In normal condition it is sampling data today), the second latest file is record 1, and so on.

If the value of designated register in “History control” is n, the trend display object will display data record n.

Here is an example to explain usage of “History control.” In the above picture, the designated register is [LW200], if the sampling data available in the files are pressure_20061120.dtl, pressure_20061123.dtl, pressure_20061127.dtl, and pressure_20061203.dtl and it is 2006/12/3 today. Based on the value of [LW200], the sampling data files selected by the trend display object is shown as follows:

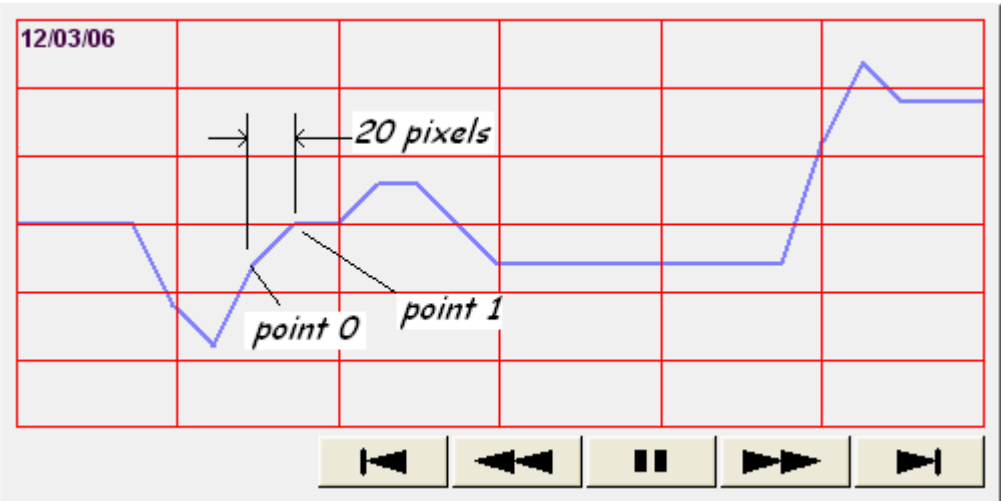
	<table border="1"> <thead> <tr> <th>Value of [LW200]</th> <th>The files of the sampling data from the historical record</th> </tr> </thead> <tbody> <tr> <td>0</td> <td>pressure_20061203.dtl</td> </tr> <tr> <td>1</td> <td>pressure_20061127.dtl</td> </tr> <tr> <td>2</td> <td>pressure_20061123.dtl</td> </tr> <tr> <td>3</td> <td>pressure_20061120.dtl</td> </tr> </tbody> </table>	Value of [LW200]	The files of the sampling data from the historical record	0	pressure_20061203.dtl	1	pressure_20061127.dtl	2	pressure_20061123.dtl	3	pressure_20061120.dtl
Value of [LW200]	The files of the sampling data from the historical record										
0	pressure_20061203.dtl										
1	pressure_20061127.dtl										
2	pressure_20061123.dtl										
3	pressure_20061120.dtl										
<p>[Distance between data samples] / Pixel</p>	<p>[Pixel]</p> <div style="border: 1px solid #ccc; padding: 5px; margin-bottom: 10px;"> Distance between data samples : <input checked="" type="radio"/> Pixel <input type="radio"/> Time Distance : <input type="text" value="20"/> pixel(s) </div> <p>Select [Pixel], the [Distance] can be used to set the distance between two sampling points. See the picture below.</p> 										
<p>[X axis time range] / Time</p>	<p>[Time]</p> <div style="border: 1px solid #ccc; padding: 5px; margin-bottom: 10px;"> X axis time range : <input type="radio"/> Pixel <input checked="" type="radio"/> Time Distance : <input type="text" value="20"/> second(s) </div> <p>Select [Time], the [Distance] is used to set the X-axis in unit of time elapsed. See the picture below.</p>										

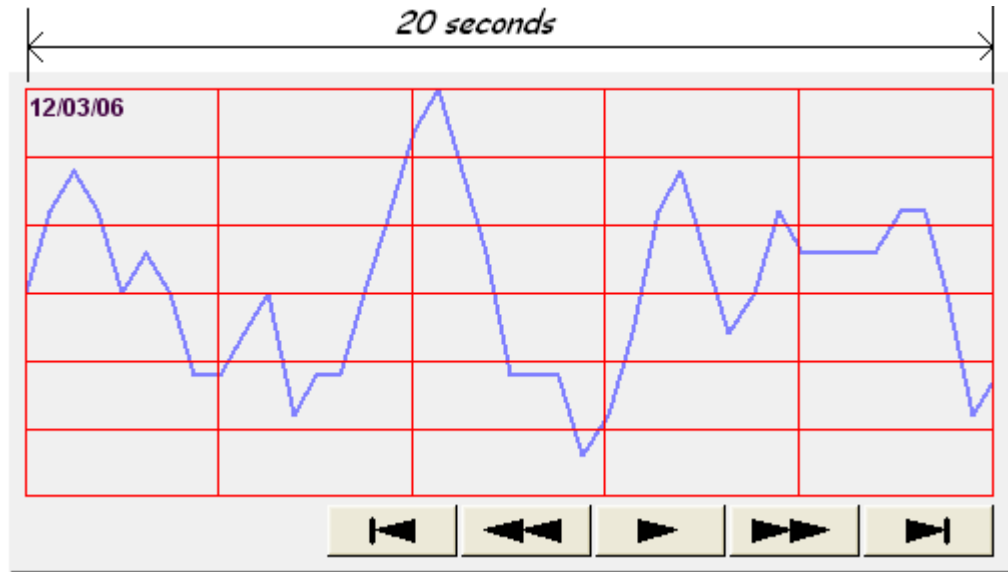

Otherwise, select Time for X axis time range and go to Trend/Grid for enable "Time scale" function. Please refer "Time scale" on the following.

Watch line

Using the "Watch line" function, when user touches the trend display object, it will display a "watch line", and export the sampling data at the position of watch line to the designated word device. You may register a numeric display object to display the result. Please refer to the following picture

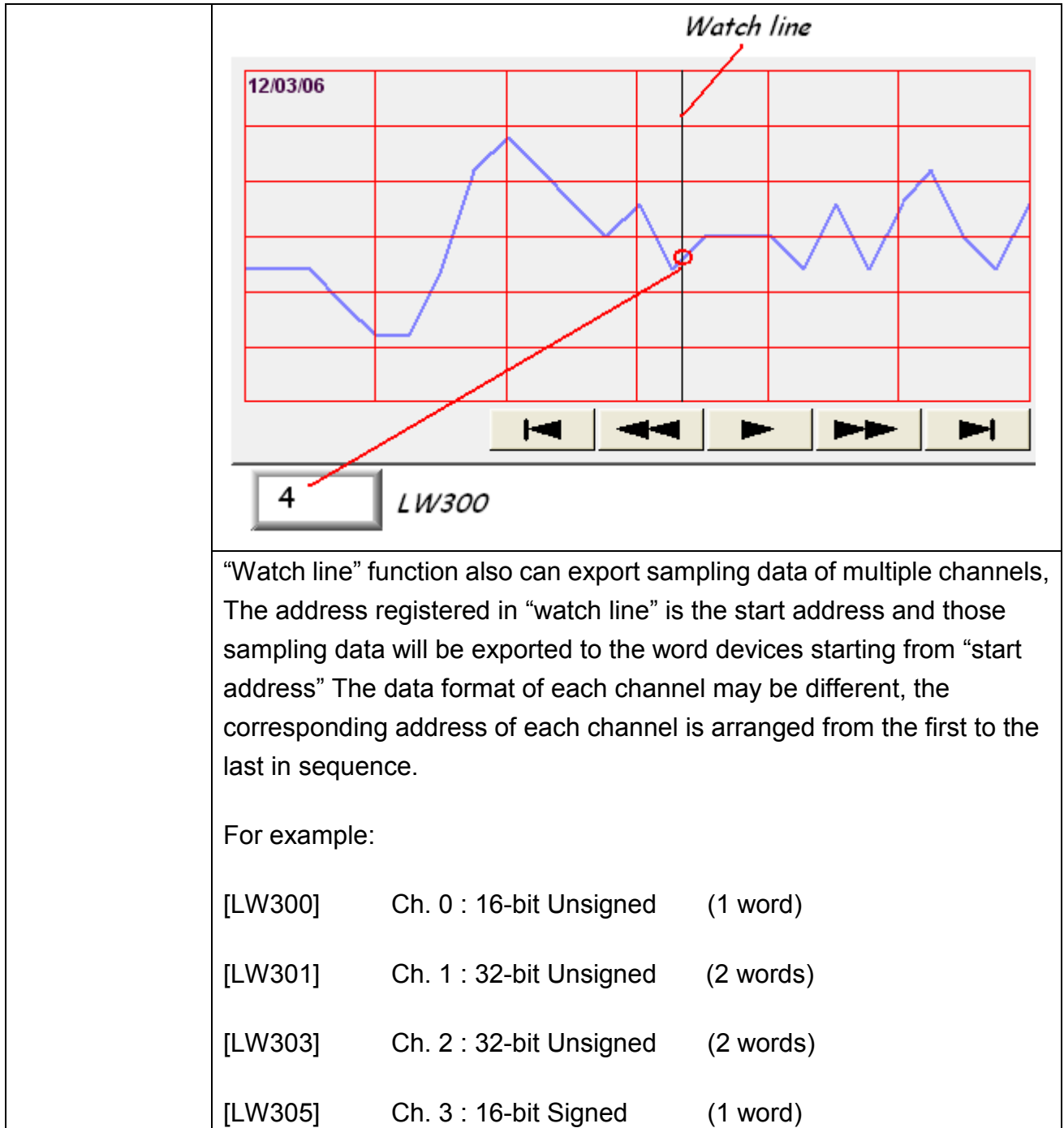

The picture below shows the attribute of “trend display”.

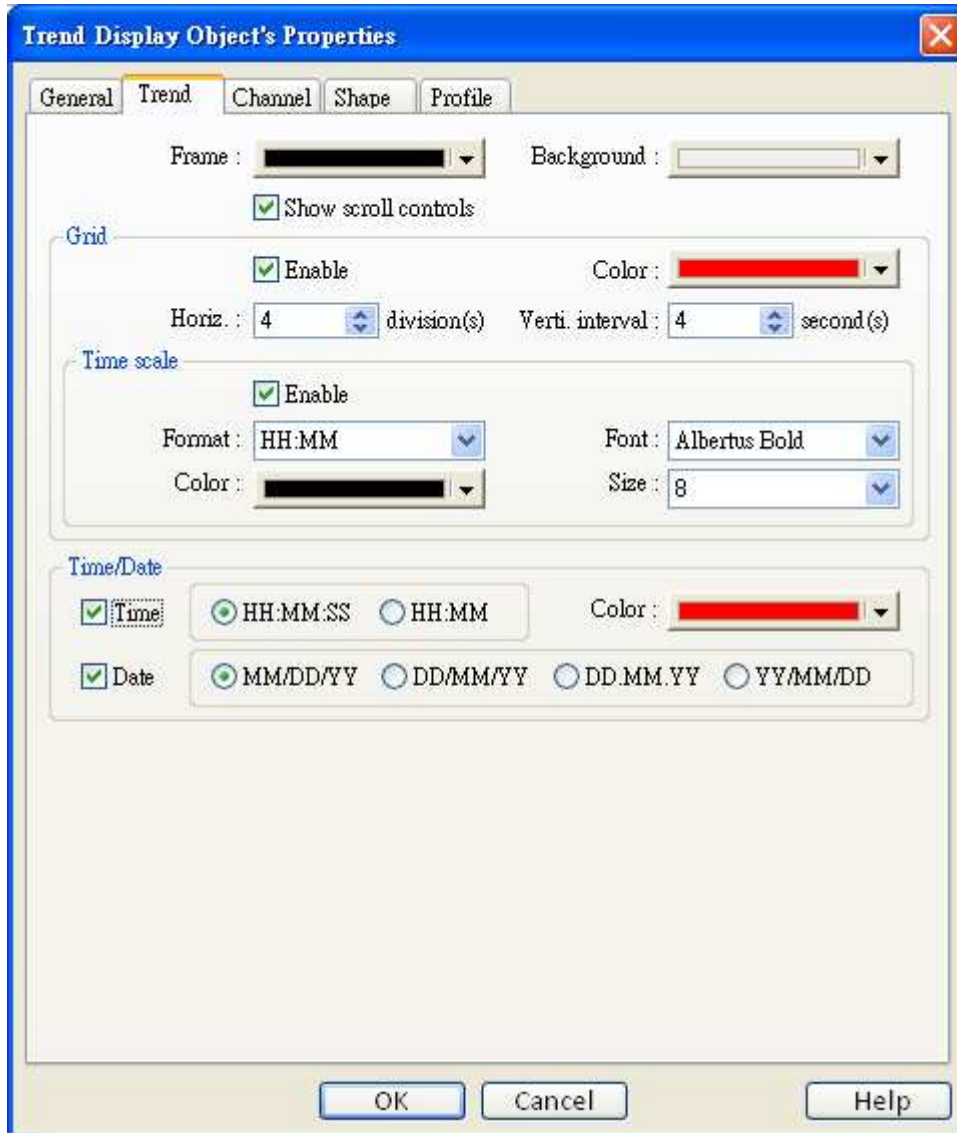

Setting	Description
[Frame]	The color of frame.
[Background]	The color of background.
[Show scroll controls]	To enable / disable scroll control on the bottom of trend display object. 
Grid	Set the distance and the color of grid.
	[Horiz.] Set the number of horizontal line.
	[Verti. interval] a. Pixel Point distances : <input checked="" type="radio"/> Pixel <input type="radio"/> Time When select [pixel] to set the display interval (see note on the above

graph and “General” tab), the [Verti. interval] is used to select how many sampling point will be included between two vertical grid line. See the picture below.

Verti. interval : point(s)

b. Time

When select [Time] to set the time range of display data, the [Verti. interval] is used to select the time range between two vertical grid lines. See the picture below.

Verti. interval : second(s)

According to these settings, the system will calculate the number of vertical grid line automatically.

Time Scale

To enable the time scale on the bottom of trend display

[Format]

To select time scale as HH:MM or HH:MM:SS

[Font]

To select font style

[Size]

To select font size. Recommend use font size: 8.

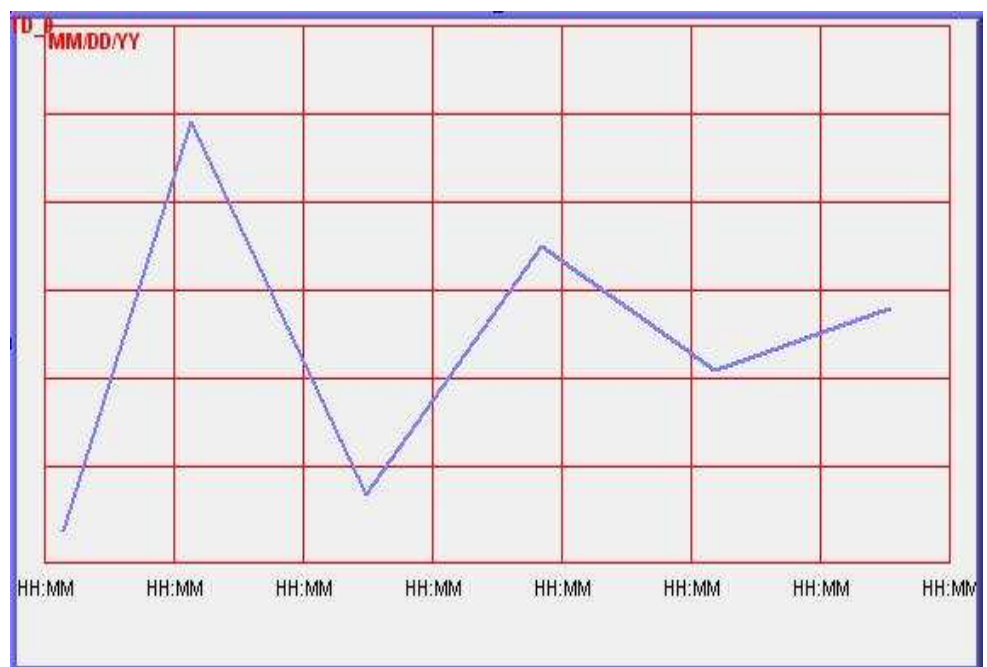

Time / Date	The time of latest sampling data will be marked on the top left corner of the object. It is used to set the time display format and color.
--------------------	--

The picture below shows the attribute of “channel tab”.

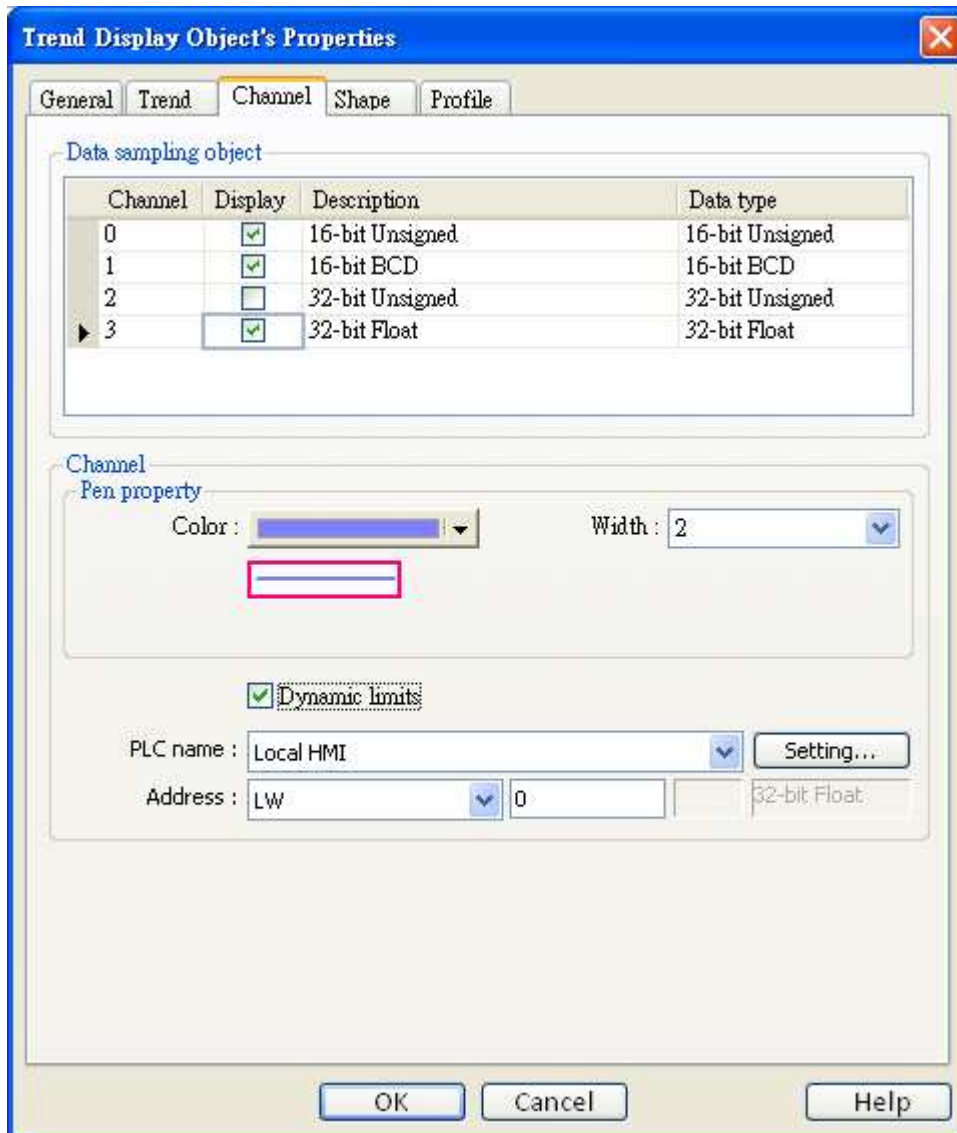

Setting	Description
[Channel]	Set each sampling line's format and color, and the display data's low limit and high limit. The max. channel can up to 20 channels.
Limit / uncheck "Dynamic"	[Zero]、 [Span]

limits”	[Zero] and [Span] are used to set the low limit and high limit of sampling data, So if the low limit is 50 and high limit is 100 for one sampling line, then [Zero] and [Span] must be set as [50] and [100], so all the sampling data can be displayed in the trend display object.									
Limit / check “Dynamic limits”	When Dynamic Limits is selected, the low limit and high limit are derived from the designated word device. The data length of the word device for limits is related to the data format of object. In the example below, <table border="1" data-bbox="493 725 1198 880" style="margin: 10px auto;"> <thead> <tr> <th>Data Format</th> <th>Low limit</th> <th>High limit</th> </tr> </thead> <tbody> <tr> <td>16-bit format</td> <td>Address</td> <td>Address + 1</td> </tr> <tr> <td>32-bit format</td> <td>Address</td> <td>Address + 2</td> </tr> </tbody> </table> An extended function is zoom in and zoom out function.	Data Format	Low limit	High limit	16-bit format	Address	Address + 1	32-bit format	Address	Address + 2
Data Format	Low limit	High limit								
16-bit format	Address	Address + 1								
32-bit format	Address	Address + 2								

Example of zoom in/out function

For zoom in / out the trend graph, user has to check the Limit/Dynamic limits as picture below.

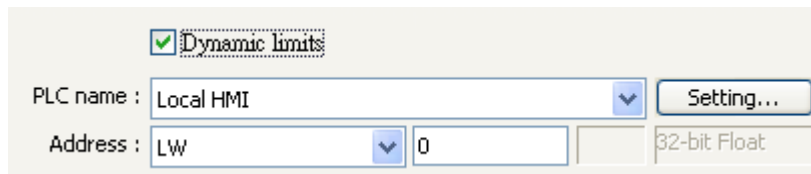

For example, the LW0 and LW1 are to control low limit and high limit, you may change the value of LW1 to zoom in / out.

This following picture is in original size. The range of trend is between 0~30. The arrow on the right side are set word (LW1, increment (JOG+) and LW1, decrement (JOG-)) for control the zoom in and zoom out function.

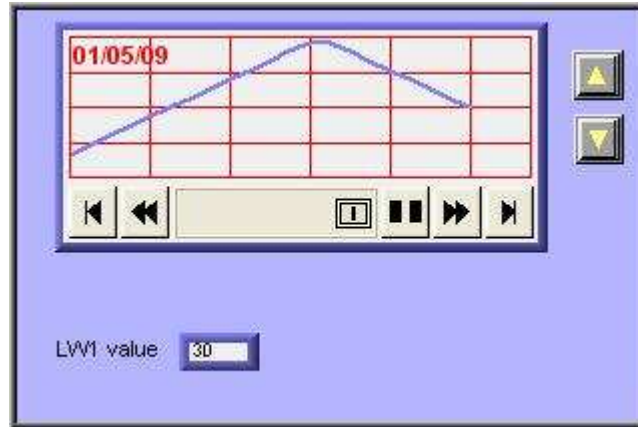

Decrease LW1's value to exhibit zoom in function as shown below:
The value of LW1 decreased to 11.

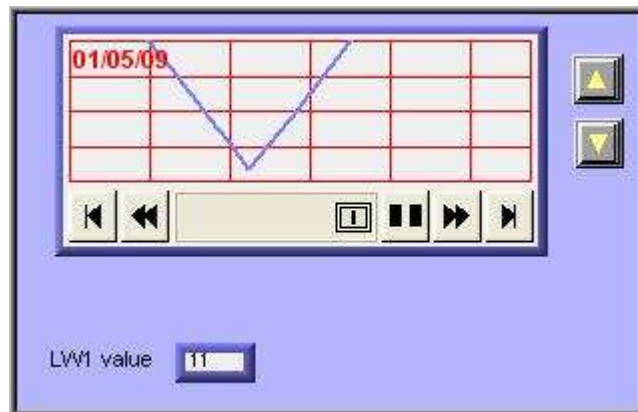

Increase LW1's value to exhibit zoom out function as shown below:
The value of LW1 increased to 41.

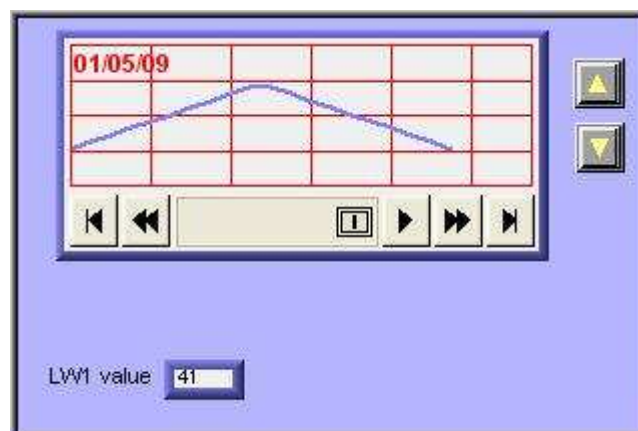

13.18 History Data Display

Overview

“History Data Display” object displays data stored by data sampling object. It displays history data in numeric format. Please note that the history data display will not refresh automatically, it only retrieve the data from the designated record and display at the time window popup. If the content of the designated record is updated, the history data display will not change accordingly.

No.	Time	Date	Ch.0	Ch.1	Ch.2
3577	21:52	16/09/07	0	0	0
3576	21:52	16/09/07	0	0	0
3575	21:52	16/09/07	0	0	0
3574	21:52	16/09/07	0	0	0
3573	21:52	16/09/07	0	0	0
3572	21:52	16/09/07	0	0	0
3571	21:52	16/09/07	0	0	0
3570	21:52	16/09/07	0	0	0
3569	21:52	16/09/07	0	0	0
3568	21:52	16/09/07	0	0	0

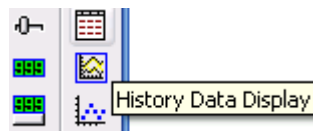

Configuration

Click the “History Data Display” icon on the toolbar, the “History Data Display” dialogue box show up on the screen. Fill in each items and click OK button, a new object will be created. See the pictures below.

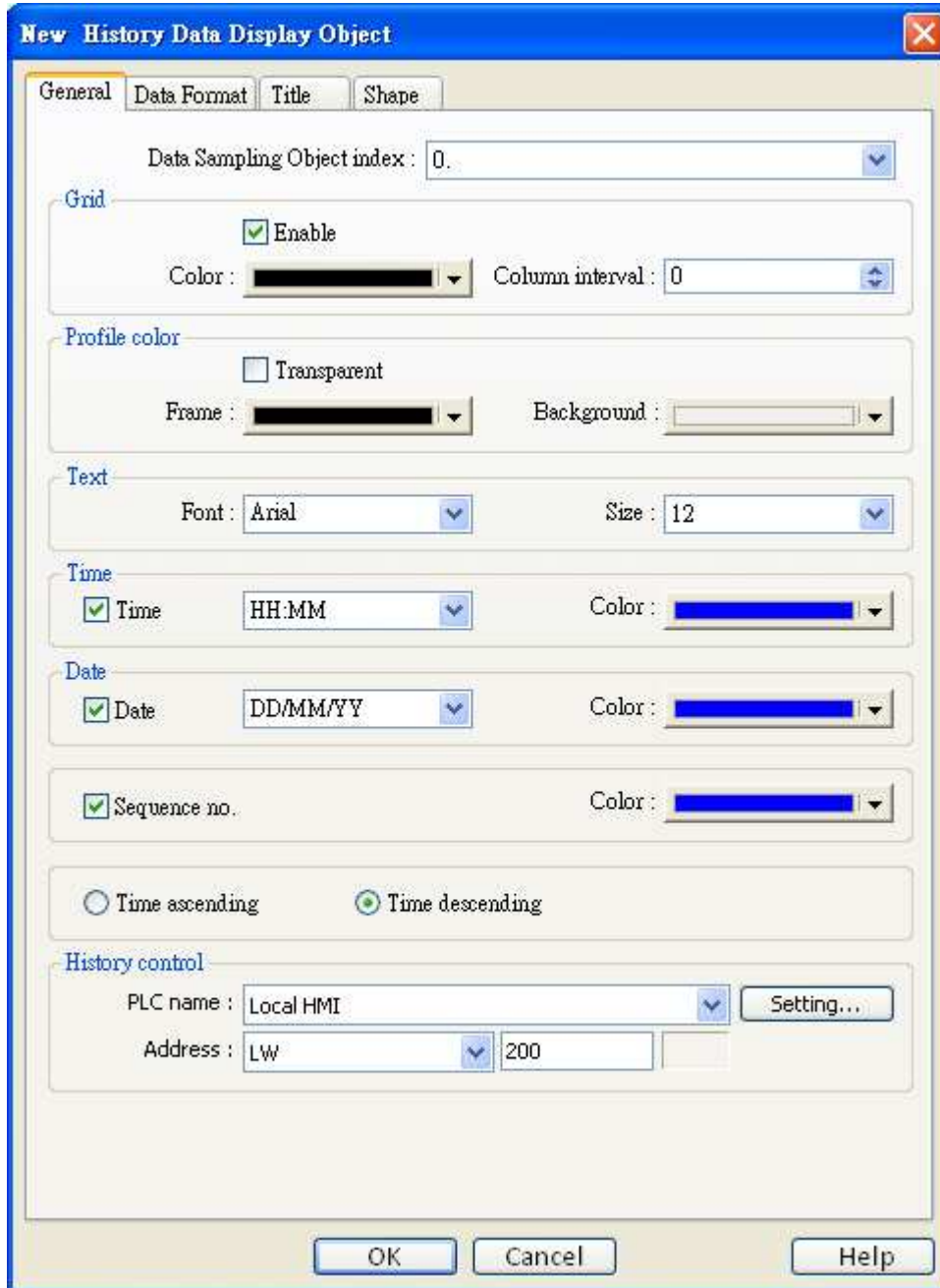

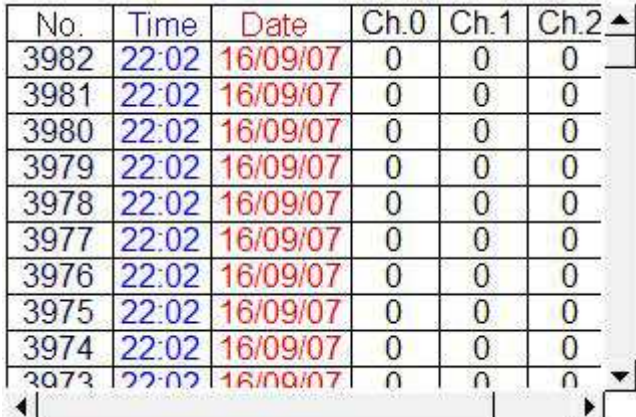
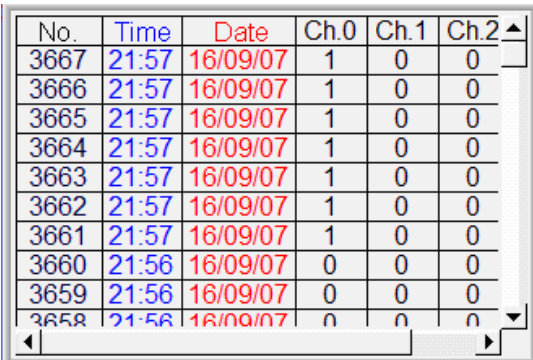

Setting	Description
[Data Sampling object index]	Select the corresponding “Data sampling object” where the history data comes from.
Grid	Set grid enable or disable.

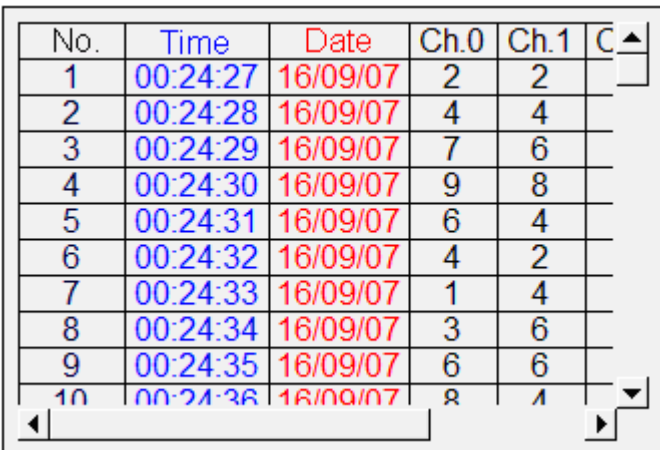
	
	<p>[Color] Set color of grid.</p> <p>[Column interval] Set space of column.</p> <div style="display: flex; justify-content: space-around;">   </div>
<p>Profile color</p>	<p>Set color of frame and background. If it is set as transparent, the frame and background will be ignored.</p>
<p>Time and Date</p>	<p>Enable or disable the time and date of data sampling and format.</p> <p>[Time ascending] “Time ascending” means to put the earlier data in the top and the latest data in the bottom.</p> 

[Time descending]

“Time descending” means to put the latest data in the top and the earlier data in the bottom.

No.	Time	Date	Ch.0	Ch.1	C
4787	22:24:15	16/09/07	2	2	
4786	22:24:00	16/09/07	3	2	
4785	22:23:59	16/09/07	3	2	
4784	22:23:58	16/09/07	3	2	
4783	22:23:57	16/09/07	3	2	
4782	22:23:56	16/09/07	3	2	
4781	22:23:55	16/09/07	3	2	
4780	22:23:54	16/09/07	3	2	
4779	22:23:53	16/09/07	3	2	
4778	22:23:52	16/09/07	3	2	

History Control

The history files are named with date code. The history control is used to select the designated history data files for display. In case the value of history control is 0, the latest file is selected. If it is 1, the second latest file is selected, and so on.

Click [Setting...] to Select the **[PLC name]**, **[Device type]**, **[Address]**, **[System tag]**, **[Index register]** of History control.

Users can also set address in General tab while adding a new object.

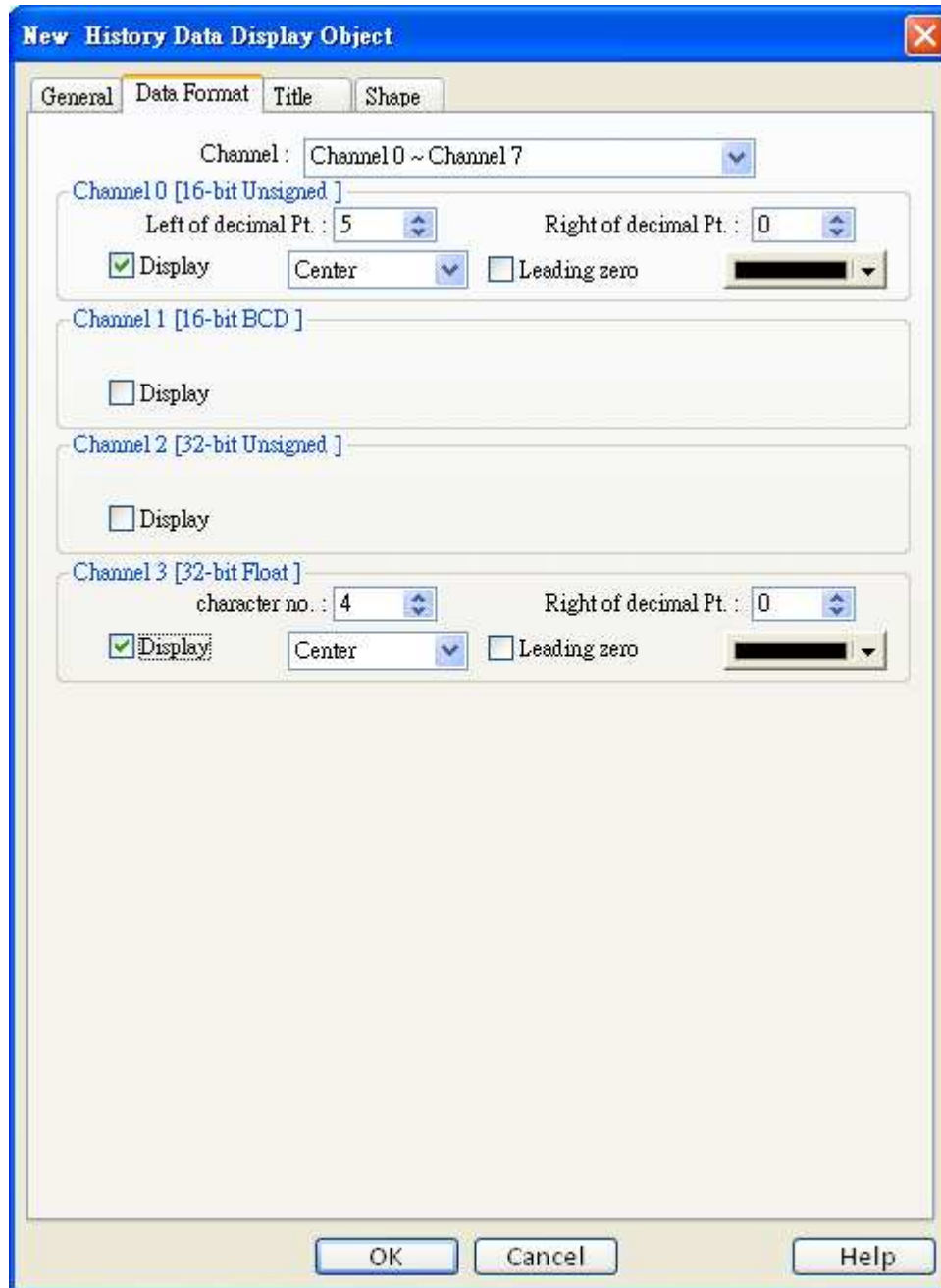

Each history data display object can display up to 20 channels. You can select the channels which you want to watch on the screen.

In the example below, there are four channels in the data sampling object, Ch.0 and Ch.3 are selected for display only. The data format of each channel is decided by the related data sampling objects.

No.	Time	Date	Ch.0	Ch.3
5272	22:43:09	16/09/07	4	1
5271	22:43:08	16/09/07	2	0
5270	22:33:42	16/09/07	0	0
5269	22:33:41	16/09/07	0	0
5268	22:33:40	16/09/07	0	0
5267	22:33:39	16/09/07	0	0
5266	22:33:38	16/09/07	0	0
5265	22:33:37	16/09/07	0	0
5264	22:33:36	16/09/07	0	0
5263	22:33:35	16/09/07	0	0

When display [String] format in history data display object, users may choose:

- Display in [UNICODE] mode
- Reverse high byte and low byte data then display.

Channel 1 [String - 5 word(s)]
character no. : 4

Display Center

UNICODE
 Reverse high/low byte

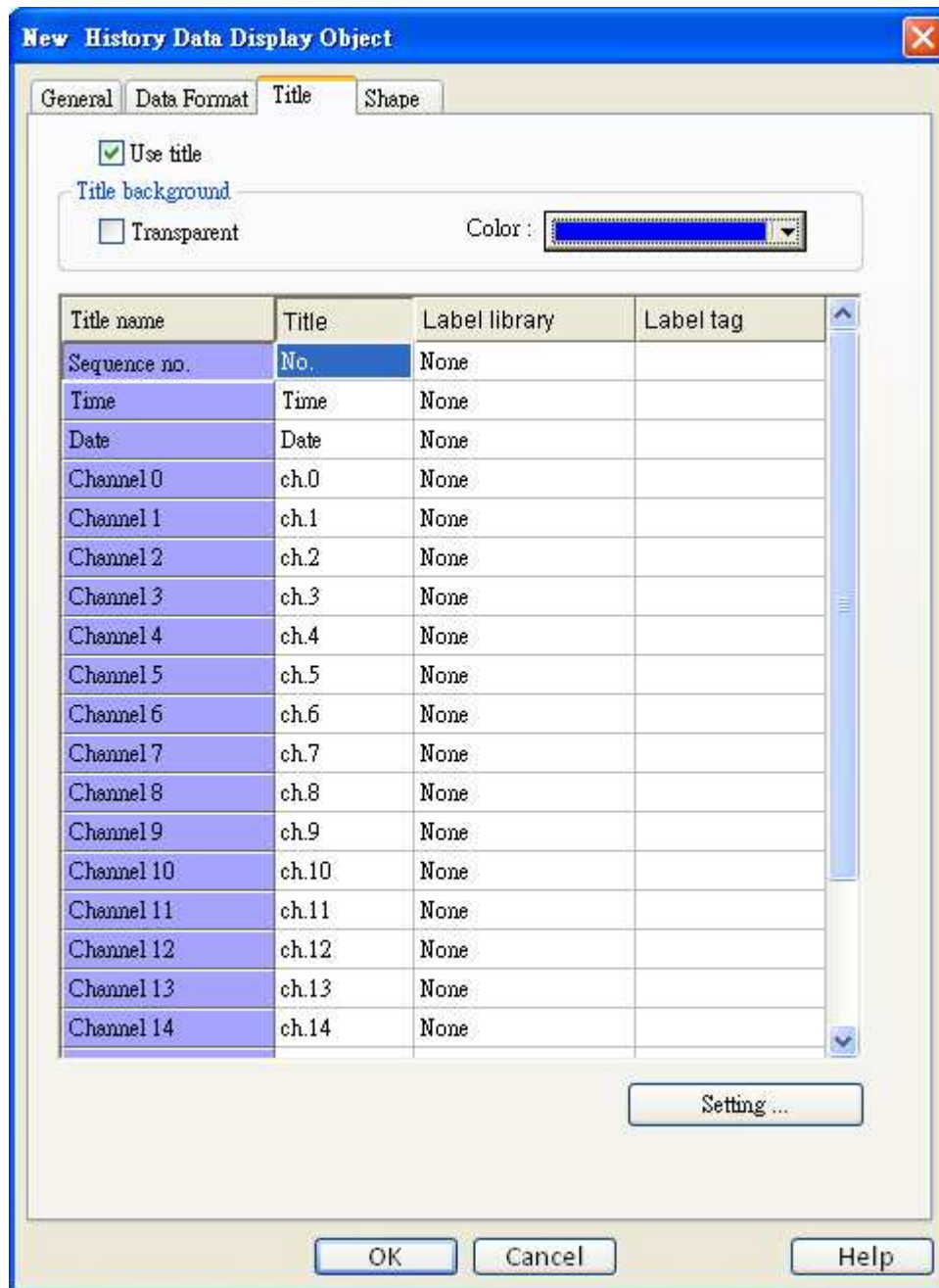

Setting	Description												
[Use title]	To enable or disable title. <table border="1" data-bbox="454 1697 973 1825"> <thead> <tr> <th>No.</th> <th>Time</th> <th>Date</th> <th>Ch.0</th> </tr> </thead> <tbody> <tr> <td>5272</td> <td>22:43:09</td> <td>16/09/07</td> <td>4</td> </tr> <tr> <td>5271</td> <td>22:43:08</td> <td>16/09/07</td> <td>2</td> </tr> </tbody> </table>	No.	Time	Date	Ch.0	5272	22:43:09	16/09/07	4	5271	22:43:08	16/09/07	2
No.	Time	Date	Ch.0										
5272	22:43:09	16/09/07	4										
5271	22:43:08	16/09/07	2										
Title background	[Transparent] To enable or disable transparent.												
	[Background color]												

	Set the background color of title.												
[Setting]	<p>This dialogue window defines the title.</p> <table border="1"><thead><tr><th>No.</th><th>Time</th><th>Date</th><th>Ch.0</th></tr></thead><tbody><tr><td>5272</td><td>22:43:09</td><td>16/09/07</td><td>4</td></tr><tr><td>5271</td><td>22:43:08</td><td>16/09/07</td><td>2</td></tr></tbody></table> <p>You can use label tag library for title with multi-language. Go to [setting] and select one from label library.</p> 	No.	Time	Date	Ch.0	5272	22:43:09	16/09/07	4	5271	22:43:08	16/09/07	2
No.	Time	Date	Ch.0										
5272	22:43:09	16/09/07	4										
5271	22:43:08	16/09/07	2										

Note:

If you have run the off-line simulation and the sampling data is saved in the record, then you want to change the format of sampling data, be sure to delete previous data record in C:\EB8000\HMI_memory\datalog to avoid the system misinterpret the old data record.

13.19 Data Block Display

Overview

Data Block is a combination of several word devices with continuous address, for example LW12, LW13, LW14, LW15 and so on. Use Data Block Display object to display multiple data blocks in trend curve, for example, it can display two data blocks LW12~LW15 and RW12~RW15 in trend curve simultaneously. It is very useful to observe and compare the difference of trend curves.

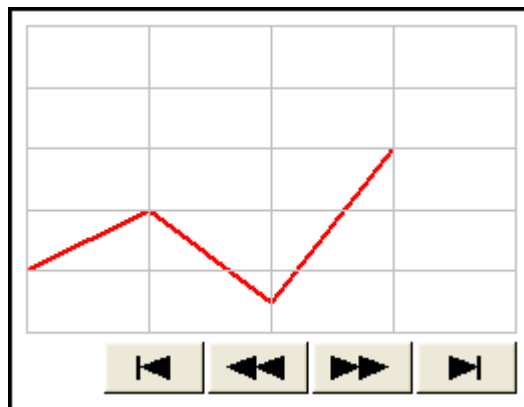
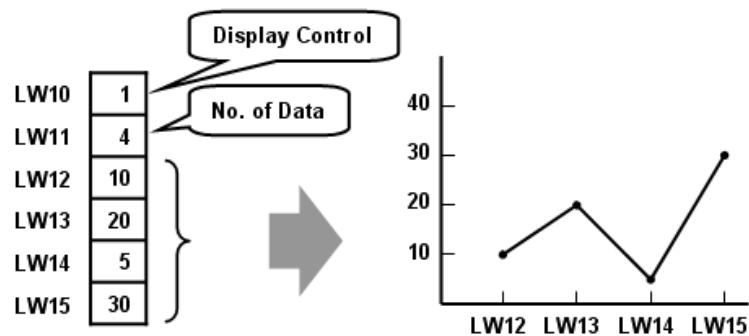

Snapshot of Data Block Display

Configuration

[New object]

Click the “Data Block Display” icon  , “Data Block Display’s properties” dialogue box appears as follows:

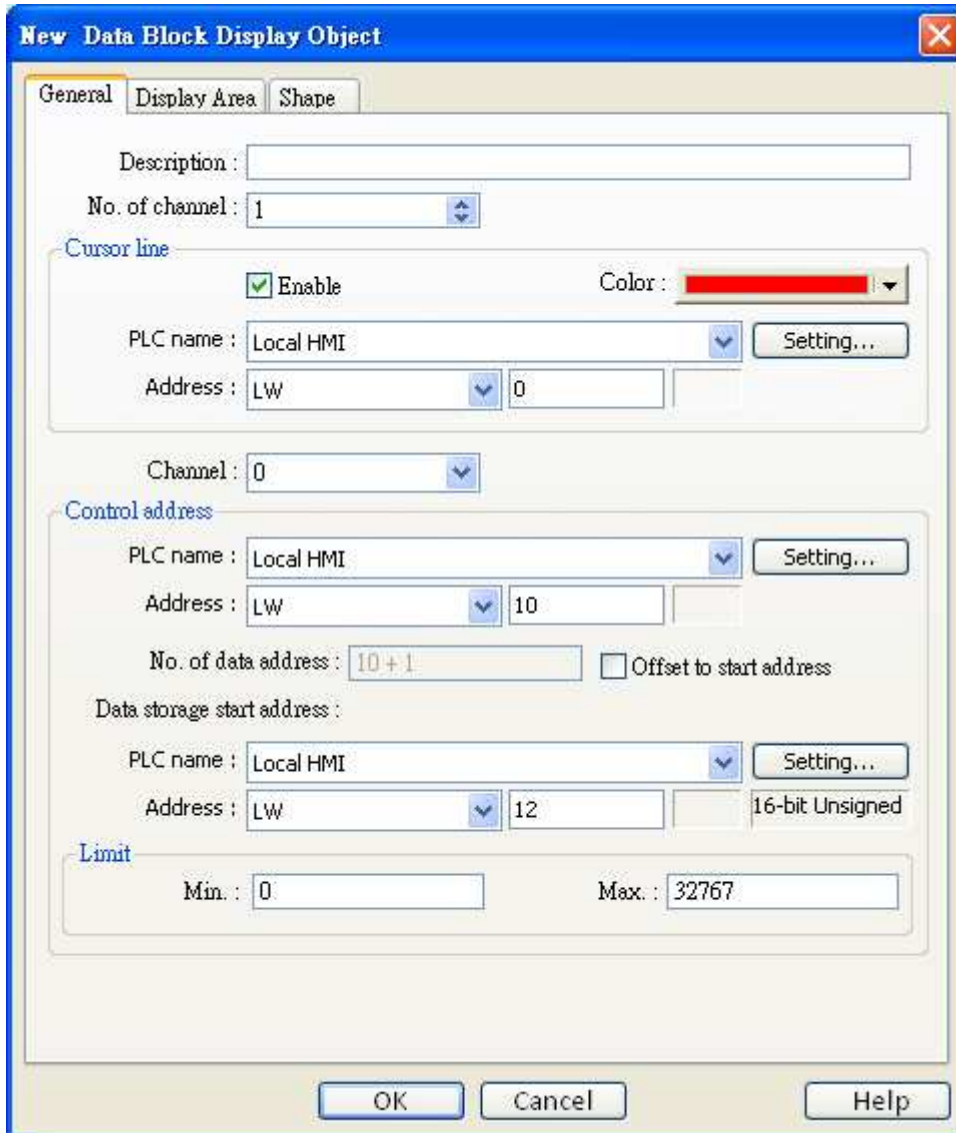

Setting	Description
[No. of channel]	Set the no of channel for this object. Each channel represents one data block. The max. no. of channel is 12.
Cursor Line	Using the “Cursor line” function, when user touches the Data Block display object, it will display a cursor line on the data block display object, and transfer the position of cursor and the data at the cursor position to

	<p>the designated registers.</p> <p>Please refer 19.3 On line operation for further information.</p>
[Channel]	Select each channel and set the attributes.
Control address	<p>[PLC name] Select the PLC where the target data block located. Click [Setting...] to Select the [PLC name], [Device type], [Address], [System tag], [Index register] of Control address. Users can also set address in General tab while adding a new object.</p> <p>[Device type] Select the device type where the target data block located.</p> <p>[Control word address] “Control word” is used to control and clear trend curve display. 0 = No action (default) 1 = Plot trend curve 2 = Clear trend curve 3 = Redraw trend curve After executing the operation above, the system will reset the control word to zero.</p> <p>[No. of data address] “No. of data address” is default as “Control word address +1”. “No. of data” is to store the number of word device in each data block, i.e. the number of data to plot in trend curve. The maximum value is 1024.</p> <p>[Data storage start address] Click [Setting...] to Select the [PLC name], [Device type], [Address], [System tag], [Index register] of Data storage start address. Users can also set address in General tab while adding a new object.</p>

	<p>.[Offset value storage address]</p> <p>If “offset to start address” is enabled, the “Offset value storage address” is default as “Control word address” + 2.</p> <p>[Format]</p> <p>If you select 16-bit data format, the address of each data will be start address, start address + 1, start address + 2 and so on.</p> <p>If you select 32-bit data format, the address of each data will be start address, start address + 2, start address + 4 and so on.</p>
Limit	<p>Set the minimum and maximum limit of trend curve, the trend curve is limited by the minimum and maximum limit.</p>

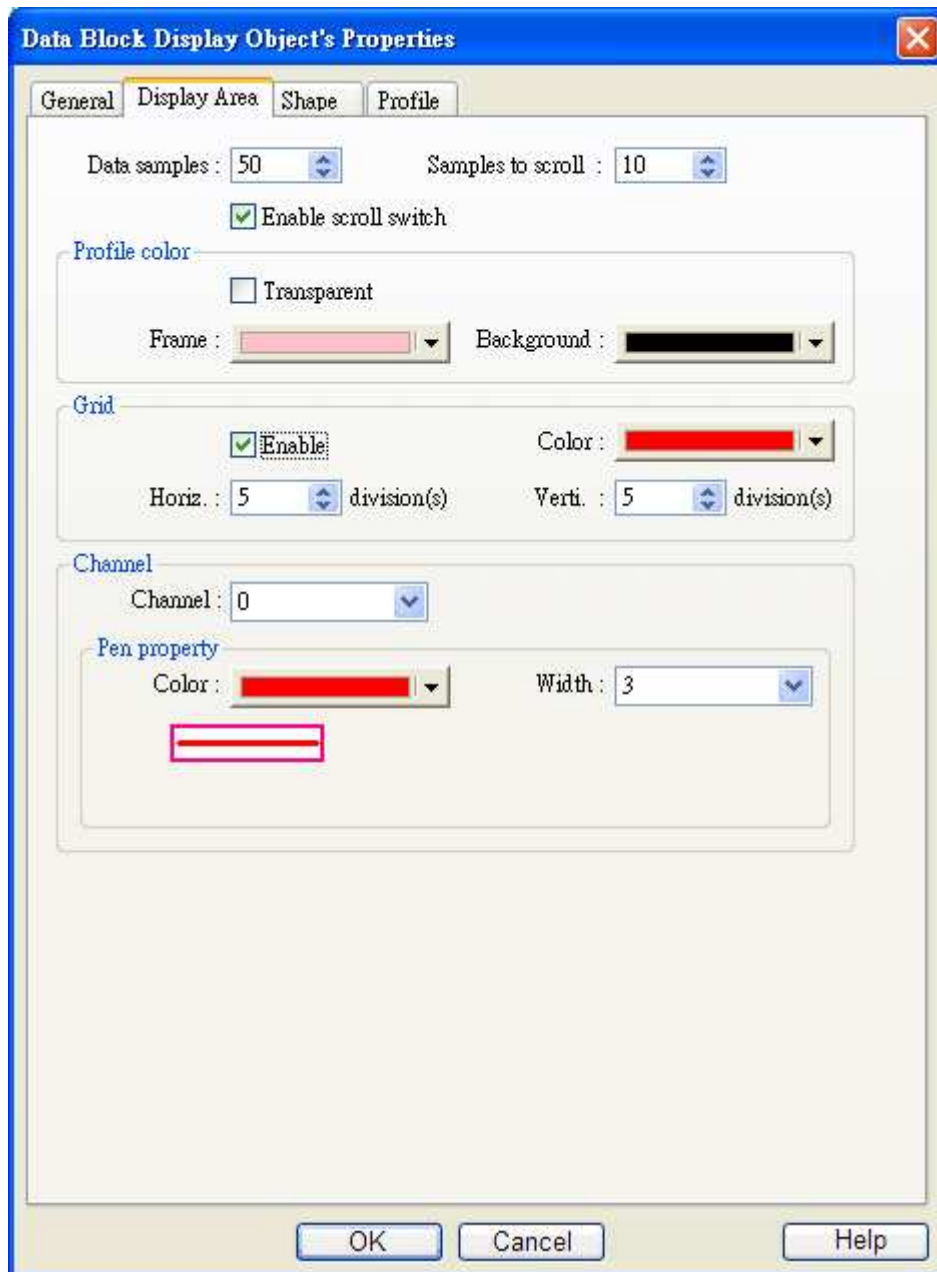

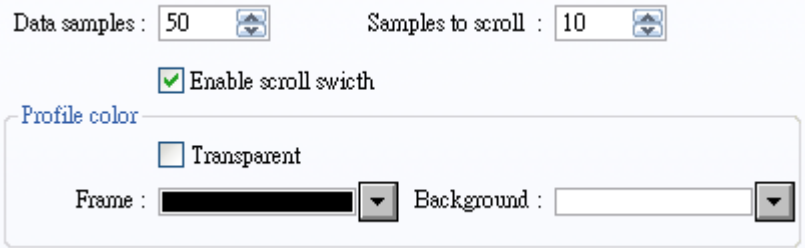

Setting	Description
[Data samples]	Set the data samples, samples to scroll, frame and color of background. 

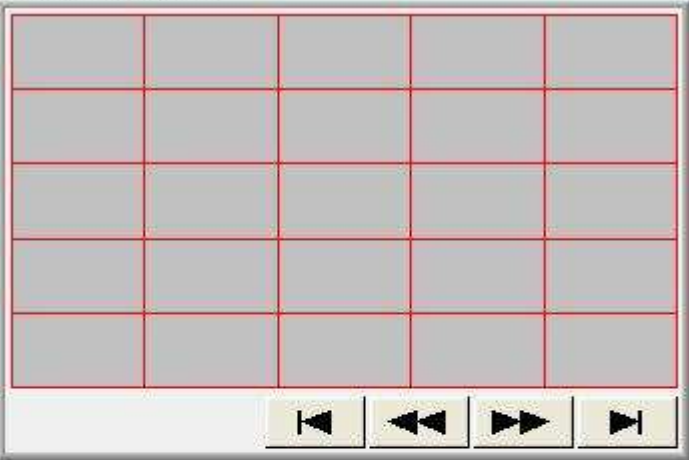
Enable background

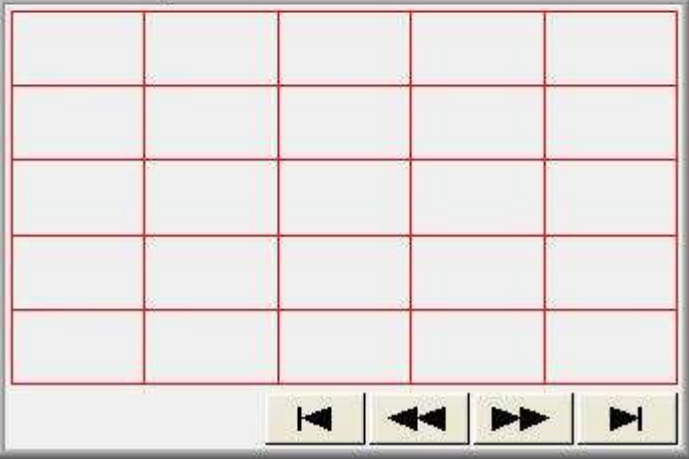

Disable background

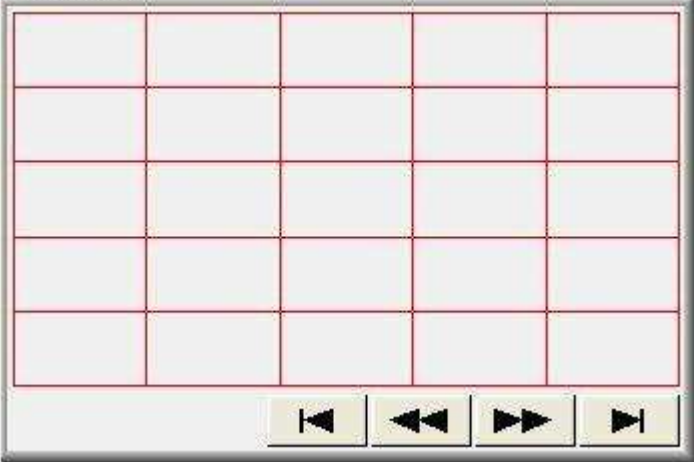

<p>Grid</p>	<p>Enable Grid</p>  <p>Disable Grid</p> 
<p>Channel</p>	<p>Set the color and width of each trend curve.</p> 

On line operation

How to show a trend curve

- Write the number of data to [No. of data address], i.e. “control word address+1”
- Have the content of data block ready for display.

NOTE: data block start from “control word address + 2”.

- Write “1” to [Control word address], the previous trend curve remains and the new content in data block will be plot on the screen.
- The system will write “0” to [Control word address] after the trend curve displayed.

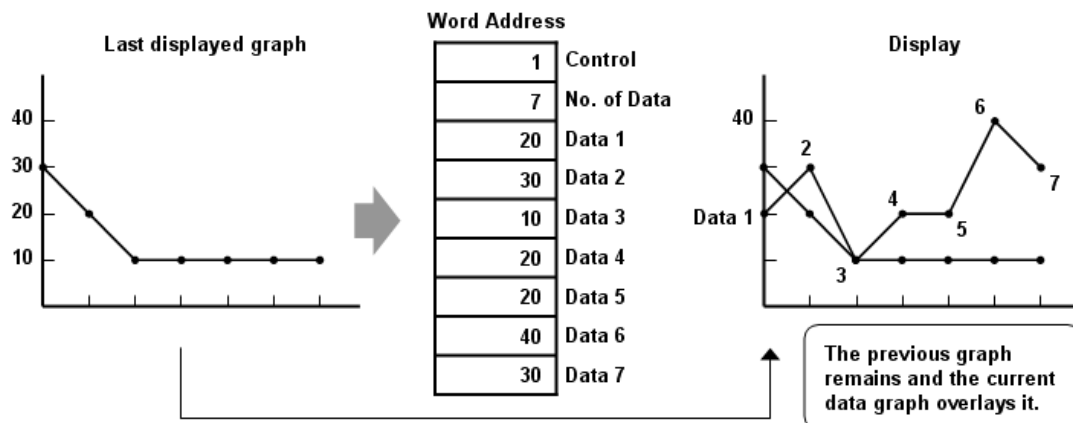

NOTE : During the period between c and d, do not change the content of [Control], [No. of Data] and [Data], it might cause error for trend curve plot.

How to clear a trend curve

- Write “2” to [Control word address], all the trend curves will be cleared.
- The system will write “0” to [Control word address] after the trend curve is cleared.

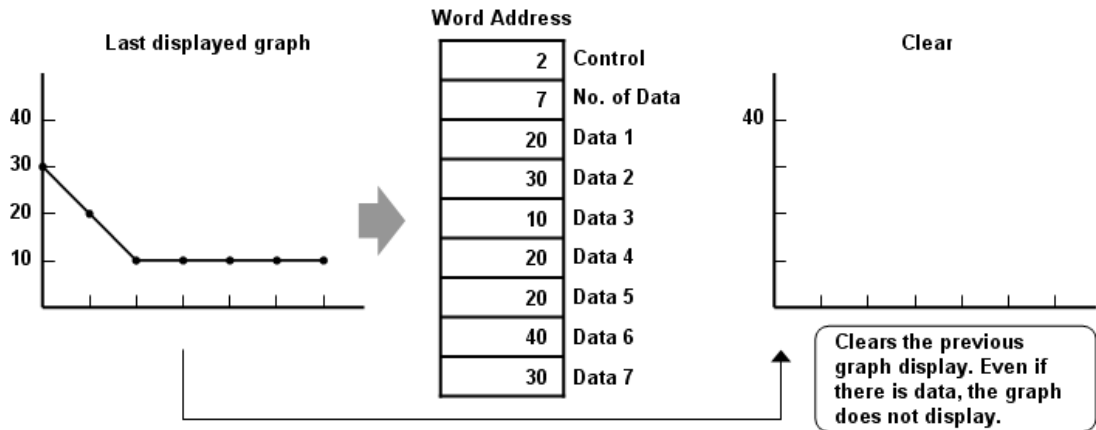

How to clear the previous trend curve and display new one

- Write the number of data to [No. of data address], i.e. “control word address+1”
- Have the content of data block ready for display.
Note: data block start from “control word address + 2”.
- Write “3” to [Control word address], the previous trend curves will be cleared and the new content in data block will be plot on the screen.
- The system will write “0” to [Control word address] after the trend curve displayed.

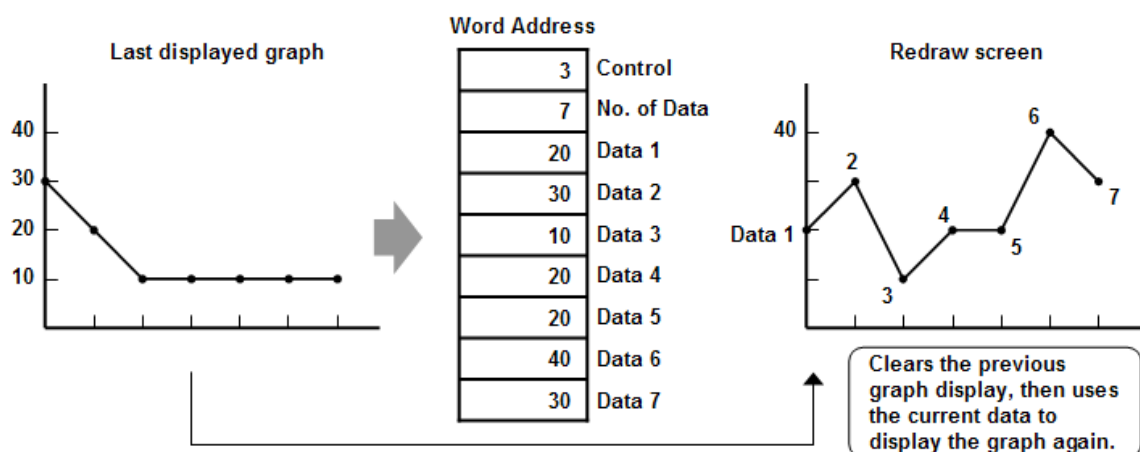

How to use offset mode

If “offset to start address” is selected, the “Data storage start address” will be calculated from “control word address + [Offset value storage address]”. “Offset value storage address” is “control word address +2”.

In the following example, the content of “Offset value storage address” is “m”, therefore the data block is started from the address “control word address + m”.

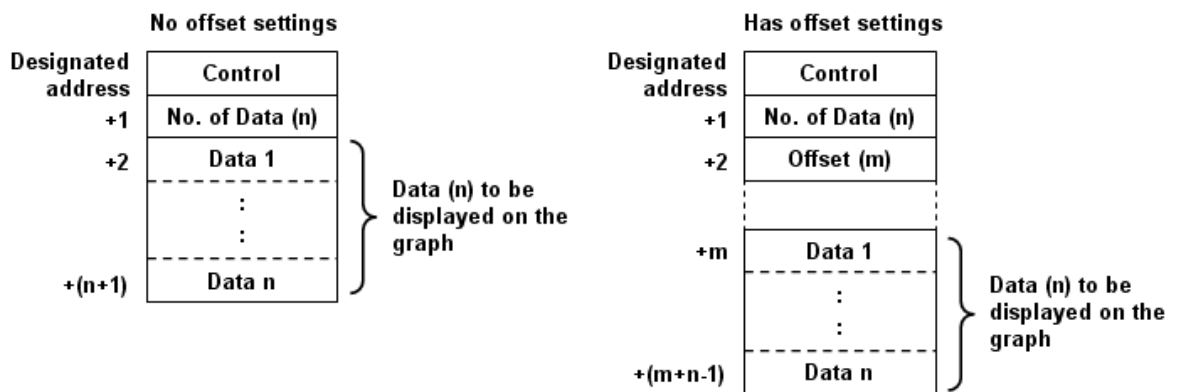

NOTE

If the control register is 32 bits device, only bit 0-15 will be used as control purpose, bit 16-31 will be ignored. (as illustration below)

32 bit device		
	31	16 15 0
+0	0	Control
+1	0	No. of Data
+2	0	Offset

If you do not use “offset to start address”, the system will continuously read [Control] and [No. of Data]. At the time [Control] is changed to non-zero, the system will then read

the data block. If you use “offset to start address”, the system will continuously read [Control], [No. of Data] and [Offset].

It is recommended to use “offset to start address” for data block display with multiple channels and the same device type. You can register [Control], [No. of Data] and [Offset] in continuous address for each channel. The system will read the control words of all the channels in one read command and it shall speed up the response time.

Please refer to the following picture. The control words of channel 1 is located from address 0, the control words of channel 2 is located from address 3, there are continuous address and the system will read all the control words in one read command.

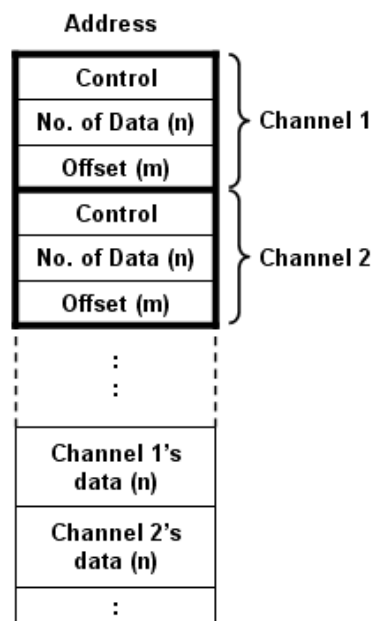

How to use watch (Cursor Line) feature

Cursor line

Enable Color :

PLC name : Local HMI

Device type : L W

Address : 1

You may use the “Watch” function to check the value of any point in trend curve. When operator touches the data block object, it will display a “Cursor line”, the system will write the index and value of that data in cursor line to the designated address. The user shall register NI objects with the designated address. The operator shall be able to observe the numeric value in across with the cursor line.

In the following example, the data block display contains two data blocks. The data format of channel 1 is 16 bit BCD and that of channel 2 is 32 bit unsigned. The cursor is positioned in data index 3 which is corresponding to the fourth data in data block. The system writes “data index” and the content of watched data to the watch address as shown in the following picture.

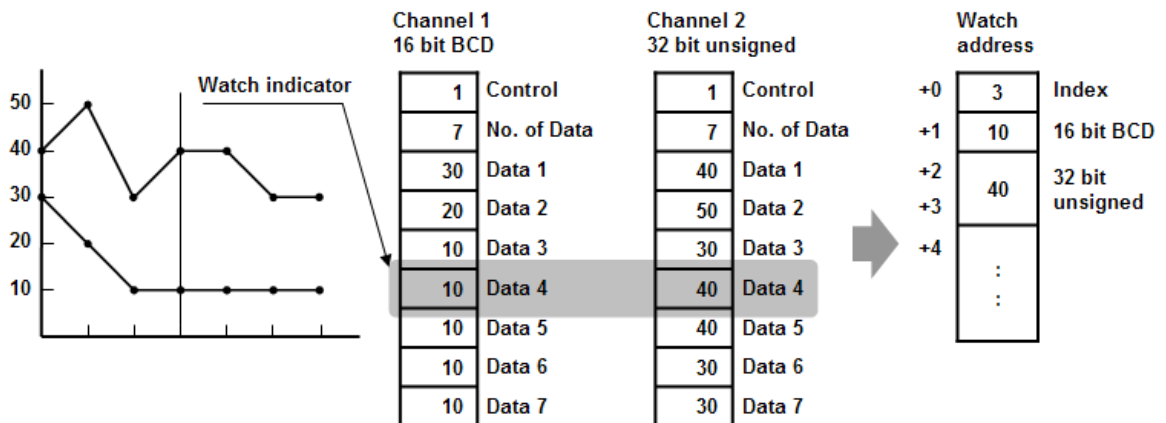

NOTE 1. [Data Index] is a 16 bit unsigned integer; when the designated register of cursor line is 32 bit device, it will be stored in the bit 0-15.

2. The watch function can only inspect current value in the data block. If there are multiple trend curves of the same channel on the screen, the data of previous trend curves is not exist, only the

latest value is available for watch.

3. If the trend curve is cleared, when position the cursor line, the “0” will be displayed as shown below.

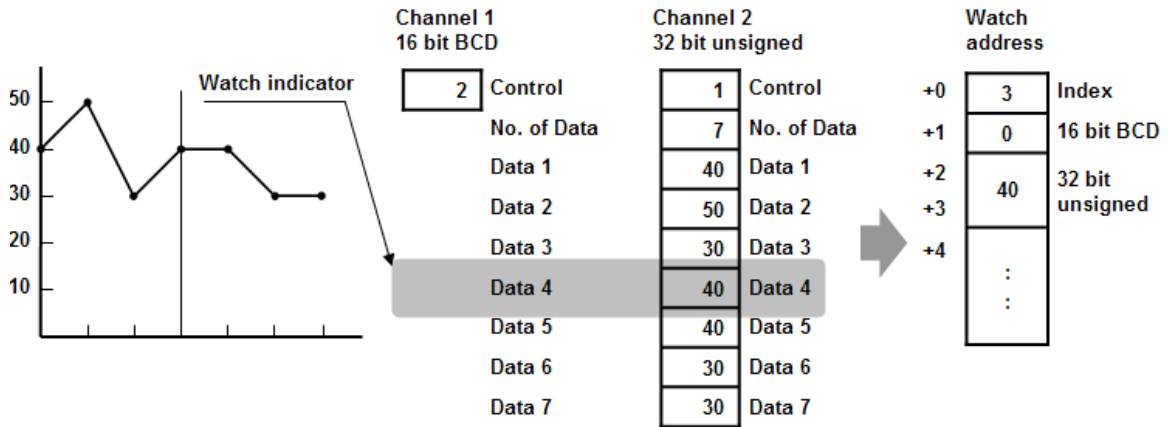

4. If there are only three data in Channel 1, when position the cursor in Data 4, the “0” will be displayed as shown below.

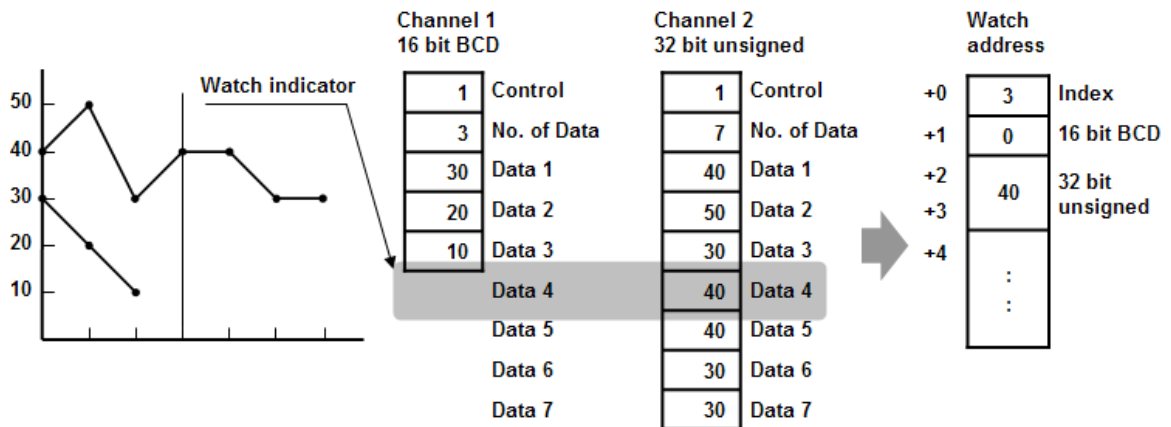

Limitation:

1. The maximum number of channels is 12.
2. The system can draw up to 32 trend curves.
3. The system can draw up to 1024 points for each channel.

13.20 XY Plot

Overview

XY Plot object displays two dimension data. Each data contains X and Y values and each curve is composed of a stream of XY data. The maximum number of trend curves in a XY plot is 16 channels.

Configuration

[New object]

Click the “XY plot” icon , and “XY Plot Object” dialog box appears.

New XY Plot Object

General | Display Area | Shape

Description :

Direction : Right | No. of channels : 2

Control Address

PLC name : Local HMI | Setting...

Address : LW | 10

No. of data address : 10 + 1

Channel : 0

Read address

PLC name : Local HMI

Separated address for X and Y data

X data

PLC name : Local HMI | Setting...

Address : LW | 100 | 16-bit Unsigned

Y data

PLC name : Local HMI | Setting...

Address : LW | 200 | 16-bit Unsigned

Limits

Dynamic limits

X axis

Low : 0 | High : 32767

Y axis

Low : 0 | High : 32767

OK | Cancel | Help

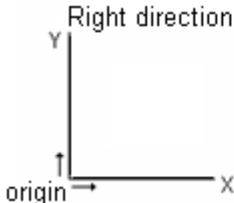
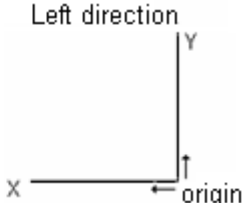
Setting	Description
General	<p>a. Direction: There are four selections, right, left, up or down.</p> <p>Right:</p>  <p>Left:</p> 

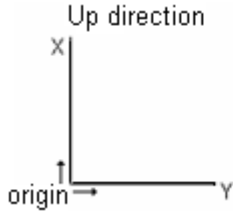
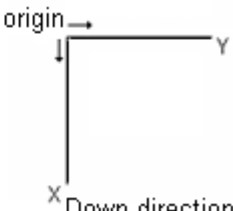
	<p>Up: </p> <p>Down: </p> <p>b. No. of channel. Set the no. of channels of the XY plot. Each channel may conduct the draw operation alone.</p>
<p>Control address</p>	<p>[PLC name] Select the PLC where the control address coming from Click [Setting...] to Select the [PLC name], [Device type], [Address], [System tag], [Index register] of Control address. Users can also set address in General tab while adding a new object.</p> <p>[Device type] Select the device type where the control address coming from.</p> <p>[Control address] “Control address” is used to control the display of XY curve for each channel.</p> <p>1= Plot XY curve Write "1" to control address, the system will plot the XY curve, the previous XY curve if exists would not be clear. The system will reset the control address after operation complete.</p> <p>2= Clear XY trend curve Write "2" to control address, the system will clear all the previous XY curves and reset the control address after operation complete.</p> <p>3= Refresh XY trend curve Write "3" to control address, the system will clear the previous XY curve and plot the new XY curve and reset the control address after operation complete.</p>

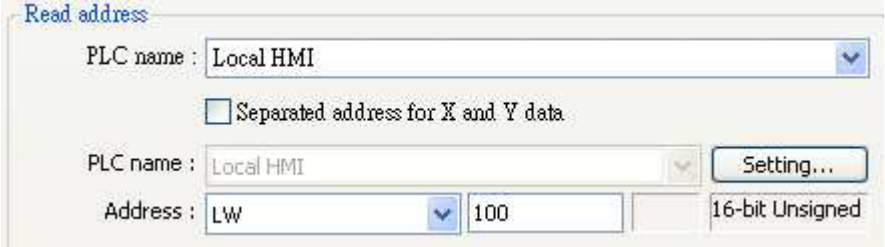
	<p>[No. of data address] This address store the number of XY data. Each channel can have up to 1023 XY data.</p>
<p>Channel</p>	<p>Setting the channels detail for graph display.</p>
<p>Read Address</p>	<p>[PLC name] Select the PLC where the control address coming from. Click [Setting...] to Select the [PLC name], [Device type], [Address], [System tag], [Index register] of Read address. Users can also set address in General tab while adding a new object.</p> <p>[PLC address]</p>  <p>Click [Setting...] to Select the [PLC name], [Device type], [Address], , [Index register], for read address.</p> <ul style="list-style-type: none"> ● The usage of each address as follows, (Dynamic limits is not enabled.) For example: The Read address is LW100. X data 0 reads value from reading address LW100. X data 1 reads value from reading address LW101. X data 2 reads value from reading address LW102. X data 3 reads value from reading address LW103. X data 4 reads value from reading address LW104. X data 5 reads value from reading address LW105 and so on... ● The usage of each address as follows, (Dynamic limits is enabled.) For example: The Read address is LW100. X low limit reads value from reading address LW100. X high limit reads value from reading address LW101. Y low limit reads value from reading address LW102. Y high limit reads value from reading address LW103.

X data 0 reads value from reading address LW104.
 Y data 0 reads value from reading address LW105.
 X data 1 reads value from reading address LW106.
 Y data 1 reads value from reading address LW107.

If you check “Separated address for X and Y data”, it allows you to set different address for X and Y axis respectively.

- The usage of each address as follows, (Dynamic limits is **not** enabled.)

For example:

The Read address is LW100 and LW200.

X data

X low limit reads value from reading address LW100.

X high limit reads value from reading address LW101.

X data 0 reads value from reading address LW102.

X data 1 reads value from reading address LW103.

X data 2 reads value from reading address LW104.

X data 3 reads value from reading address LW105 and so on...

Ydata

Y low limit reads value from reading address LW200.

Y high limit reads value from reading address LW201.

Y data 0 reads value from reading address LW202.

Y data 1 reads value from reading address LW203.

Y data 2 reads value from reading address LW204.

Y data 3 reads value from reading address LW205 and so on...

Limits

The above settings are based on dynamic limits, you can also have dynamic limits disable and set the fix high and low limits.

The high and low limits is used as scale to calculate the percentage of X and Y axis. i.e. X or Y % = (X or Y reading value – low limit) / (high limit – low limit)

Based on your settings, the memory allocation for limit and XY data will be as follows.

The following setting is for 16-bit signed data format and dynamic limits.

X low limit reads value from reading address LW0.(n+0)
 X high limit reads value from reading address LW1. (n+1)
 Y low limit reads value from reading address LW2. (n+2)
 Y high limit reads value from reading address LW3. (n+3)
 X data 0 reads value from reading address LW4. (n+4)
 Y data 0 reads value from reading address LW5. (n+5)

The following setting is for 32-bit float data format and dynamic limits.

Read address

PLC name : Local HMI

Separated address for X and Y data

PLC name : Local HMI Setting...

Address : LW 100 32-bit Float

X low limit reads value from reading address LW100.(n+0)

X high limit reads value from reading address LW102. (n+2)

Y low limit reads value from reading address LW104. (n+4)

Y high limit reads value from reading address LW106. (n+6)

X data 0 reads value from reading address LW108. (n+8)

Y data 0 reads value from reading address LW110. (n+10)

NOTE

There are four different type of selection to designate memory location for high/low limits and XY data. Please refer to the following settings.

	<div style="border-bottom: 1px solid black; padding-bottom: 5px;"> <input checked="" type="checkbox"/> Separated address for X and Y data </div> <table style="width: 100%; border-collapse: collapse;"> <tr> <td style="width: 50%; border-right: 1px solid black; padding: 5px;"> <input type="checkbox"/> Dynamic limits </td> <td style="width: 50%; padding: 5px;"> <input checked="" type="checkbox"/> Dynamic limits </td> </tr> <tr> <td style="border-right: 1px solid black; padding: 5px;"> <table style="width: 100%; border-collapse: collapse;"> <tr> <th style="width: 50%;">X</th> <th style="width: 50%;">Y</th> </tr> <tr><td>Data 0</td><td>Data 0</td></tr> <tr><td>Data 1</td><td>Data 1</td></tr> <tr><td>Data 2</td><td>Data 2</td></tr> <tr><td>Data 3</td><td>Data 3</td></tr> <tr><td>⋮</td><td>⋮</td></tr> </table> </td> <td style="padding: 5px;"> <table style="width: 100%; border-collapse: collapse;"> <tr> <th style="width: 50%;">X</th> <th style="width: 50%;">Y</th> </tr> <tr><td>Min</td><td>Min</td></tr> <tr><td>Max</td><td>Max</td></tr> <tr><td>Data 0</td><td>Data 0</td></tr> <tr><td>Data 1</td><td>Data 1</td></tr> <tr><td>Data 2</td><td>Data 2</td></tr> <tr><td>⋮</td><td>⋮</td></tr> </table> </td> </tr> </table> <div style="padding-top: 10px;"> <input type="checkbox"/> Separated address for X and Y data </div> <table style="width: 100%; border-collapse: collapse;"> <tr> <td style="width: 50%; border-right: 1px solid black; padding: 5px;"> <input type="checkbox"/> Dynamic limits </td> <td style="width: 50%; padding: 5px;"> <input checked="" type="checkbox"/> Dynamic limits </td> </tr> <tr> <td style="border-right: 1px solid black; padding: 5px;"> <table style="width: 100%; border-collapse: collapse;"> <tr> <th style="width: 33%;">X</th> <th style="width: 33%;">+</th> <th style="width: 33%;">Y</th> </tr> <tr><td>X Data 0</td><td></td><td></td></tr> <tr><td>Y Data 0</td><td></td><td></td></tr> <tr><td>X Data 1</td><td></td><td></td></tr> <tr><td>Y Data 1</td><td></td><td></td></tr> <tr><td>X Data 2</td><td></td><td></td></tr> <tr><td>Y Data 2</td><td></td><td></td></tr> <tr><td>X Data 3</td><td></td><td></td></tr> <tr><td>Y Data 3</td><td></td><td></td></tr> <tr><td>⋮</td><td></td><td></td></tr> </table> </td> <td style="padding: 5px;"> <table style="width: 100%; border-collapse: collapse;"> <tr> <th style="width: 33%;">X</th> <th style="width: 33%;">+</th> <th style="width: 33%;">Y</th> </tr> <tr><td>X Min</td><td></td><td></td></tr> <tr><td>X Max</td><td></td><td></td></tr> <tr><td>Y Min</td><td></td><td></td></tr> <tr><td>Y Max</td><td></td><td></td></tr> <tr><td>X Data 0</td><td></td><td></td></tr> <tr><td>Y Data 0</td><td></td><td></td></tr> <tr><td>X Data 1</td><td></td><td></td></tr> <tr><td>Y Data 1</td><td></td><td></td></tr> <tr><td>X Data 2</td><td></td><td></td></tr> <tr><td>Y Data 2</td><td></td><td></td></tr> <tr><td>⋮</td><td></td><td></td></tr> </table> </td> </tr> </table> <p style="margin-top: 20px;">If dynamic limit is checked, you may change the high and low limits to realize zoom in and zoom out function. (Please refer trend display object's dynamic limit.)</p> <p style="margin-top: 20px;">In the following example, the dynamic limit is selected, where XL=X low limit, XH=X high limit, YL=Y low limit, YH=Y high limit, and XY, XY1, XY2 are three XY data. Now we change the high limit of X and Y respectively and you may observe the effect of zoom in and zoom out.</p>	<input type="checkbox"/> Dynamic limits	<input checked="" type="checkbox"/> Dynamic limits	<table style="width: 100%; border-collapse: collapse;"> <tr> <th style="width: 50%;">X</th> <th style="width: 50%;">Y</th> </tr> <tr><td>Data 0</td><td>Data 0</td></tr> <tr><td>Data 1</td><td>Data 1</td></tr> <tr><td>Data 2</td><td>Data 2</td></tr> <tr><td>Data 3</td><td>Data 3</td></tr> <tr><td>⋮</td><td>⋮</td></tr> </table>	X	Y	Data 0	Data 0	Data 1	Data 1	Data 2	Data 2	Data 3	Data 3	⋮	⋮	<table style="width: 100%; border-collapse: collapse;"> <tr> <th style="width: 50%;">X</th> <th style="width: 50%;">Y</th> </tr> <tr><td>Min</td><td>Min</td></tr> <tr><td>Max</td><td>Max</td></tr> <tr><td>Data 0</td><td>Data 0</td></tr> <tr><td>Data 1</td><td>Data 1</td></tr> <tr><td>Data 2</td><td>Data 2</td></tr> <tr><td>⋮</td><td>⋮</td></tr> </table>	X	Y	Min	Min	Max	Max	Data 0	Data 0	Data 1	Data 1	Data 2	Data 2	⋮	⋮	<input type="checkbox"/> Dynamic limits	<input checked="" type="checkbox"/> Dynamic limits	<table style="width: 100%; border-collapse: collapse;"> <tr> <th style="width: 33%;">X</th> <th style="width: 33%;">+</th> <th style="width: 33%;">Y</th> </tr> <tr><td>X Data 0</td><td></td><td></td></tr> <tr><td>Y Data 0</td><td></td><td></td></tr> <tr><td>X Data 1</td><td></td><td></td></tr> <tr><td>Y Data 1</td><td></td><td></td></tr> <tr><td>X Data 2</td><td></td><td></td></tr> <tr><td>Y Data 2</td><td></td><td></td></tr> <tr><td>X Data 3</td><td></td><td></td></tr> <tr><td>Y Data 3</td><td></td><td></td></tr> <tr><td>⋮</td><td></td><td></td></tr> </table>	X	+	Y	X Data 0			Y Data 0			X Data 1			Y Data 1			X Data 2			Y Data 2			X Data 3			Y Data 3			⋮			<table style="width: 100%; border-collapse: collapse;"> <tr> <th style="width: 33%;">X</th> <th style="width: 33%;">+</th> <th style="width: 33%;">Y</th> </tr> <tr><td>X Min</td><td></td><td></td></tr> <tr><td>X Max</td><td></td><td></td></tr> <tr><td>Y Min</td><td></td><td></td></tr> <tr><td>Y Max</td><td></td><td></td></tr> <tr><td>X Data 0</td><td></td><td></td></tr> <tr><td>Y Data 0</td><td></td><td></td></tr> <tr><td>X Data 1</td><td></td><td></td></tr> <tr><td>Y Data 1</td><td></td><td></td></tr> <tr><td>X Data 2</td><td></td><td></td></tr> <tr><td>Y Data 2</td><td></td><td></td></tr> <tr><td>⋮</td><td></td><td></td></tr> </table>	X	+	Y	X Min			X Max			Y Min			Y Max			X Data 0			Y Data 0			X Data 1			Y Data 1			X Data 2			Y Data 2			⋮		
<input type="checkbox"/> Dynamic limits	<input checked="" type="checkbox"/> Dynamic limits																																																																																																				
<table style="width: 100%; border-collapse: collapse;"> <tr> <th style="width: 50%;">X</th> <th style="width: 50%;">Y</th> </tr> <tr><td>Data 0</td><td>Data 0</td></tr> <tr><td>Data 1</td><td>Data 1</td></tr> <tr><td>Data 2</td><td>Data 2</td></tr> <tr><td>Data 3</td><td>Data 3</td></tr> <tr><td>⋮</td><td>⋮</td></tr> </table>	X	Y	Data 0	Data 0	Data 1	Data 1	Data 2	Data 2	Data 3	Data 3	⋮	⋮	<table style="width: 100%; border-collapse: collapse;"> <tr> <th style="width: 50%;">X</th> <th style="width: 50%;">Y</th> </tr> <tr><td>Min</td><td>Min</td></tr> <tr><td>Max</td><td>Max</td></tr> <tr><td>Data 0</td><td>Data 0</td></tr> <tr><td>Data 1</td><td>Data 1</td></tr> <tr><td>Data 2</td><td>Data 2</td></tr> <tr><td>⋮</td><td>⋮</td></tr> </table>	X	Y	Min	Min	Max	Max	Data 0	Data 0	Data 1	Data 1	Data 2	Data 2	⋮	⋮																																																																										
X	Y																																																																																																				
Data 0	Data 0																																																																																																				
Data 1	Data 1																																																																																																				
Data 2	Data 2																																																																																																				
Data 3	Data 3																																																																																																				
⋮	⋮																																																																																																				
X	Y																																																																																																				
Min	Min																																																																																																				
Max	Max																																																																																																				
Data 0	Data 0																																																																																																				
Data 1	Data 1																																																																																																				
Data 2	Data 2																																																																																																				
⋮	⋮																																																																																																				
<input type="checkbox"/> Dynamic limits	<input checked="" type="checkbox"/> Dynamic limits																																																																																																				
<table style="width: 100%; border-collapse: collapse;"> <tr> <th style="width: 33%;">X</th> <th style="width: 33%;">+</th> <th style="width: 33%;">Y</th> </tr> <tr><td>X Data 0</td><td></td><td></td></tr> <tr><td>Y Data 0</td><td></td><td></td></tr> <tr><td>X Data 1</td><td></td><td></td></tr> <tr><td>Y Data 1</td><td></td><td></td></tr> <tr><td>X Data 2</td><td></td><td></td></tr> <tr><td>Y Data 2</td><td></td><td></td></tr> <tr><td>X Data 3</td><td></td><td></td></tr> <tr><td>Y Data 3</td><td></td><td></td></tr> <tr><td>⋮</td><td></td><td></td></tr> </table>	X	+	Y	X Data 0			Y Data 0			X Data 1			Y Data 1			X Data 2			Y Data 2			X Data 3			Y Data 3			⋮			<table style="width: 100%; border-collapse: collapse;"> <tr> <th style="width: 33%;">X</th> <th style="width: 33%;">+</th> <th style="width: 33%;">Y</th> </tr> <tr><td>X Min</td><td></td><td></td></tr> <tr><td>X Max</td><td></td><td></td></tr> <tr><td>Y Min</td><td></td><td></td></tr> <tr><td>Y Max</td><td></td><td></td></tr> <tr><td>X Data 0</td><td></td><td></td></tr> <tr><td>Y Data 0</td><td></td><td></td></tr> <tr><td>X Data 1</td><td></td><td></td></tr> <tr><td>Y Data 1</td><td></td><td></td></tr> <tr><td>X Data 2</td><td></td><td></td></tr> <tr><td>Y Data 2</td><td></td><td></td></tr> <tr><td>⋮</td><td></td><td></td></tr> </table>	X	+	Y	X Min			X Max			Y Min			Y Max			X Data 0			Y Data 0			X Data 1			Y Data 1			X Data 2			Y Data 2			⋮																																				
X	+	Y																																																																																																			
X Data 0																																																																																																					
Y Data 0																																																																																																					
X Data 1																																																																																																					
Y Data 1																																																																																																					
X Data 2																																																																																																					
Y Data 2																																																																																																					
X Data 3																																																																																																					
Y Data 3																																																																																																					
⋮																																																																																																					
X	+	Y																																																																																																			
X Min																																																																																																					
X Max																																																																																																					
Y Min																																																																																																					
Y Max																																																																																																					
X Data 0																																																																																																					
Y Data 0																																																																																																					
X Data 1																																																																																																					
Y Data 1																																																																																																					
X Data 2																																																																																																					
Y Data 2																																																																																																					
⋮																																																																																																					

XL XH YL YH
 0 50 0 50
 XY XY1 XY2
 5 1 10 45 30 20
 LW100 control LW101 display number
 0 3

1. Change Y high limit to 25 for zoom in effect.

XL XH YL YH
 0 50 0 25
 XY XY1 XY2
 5 1 10 45 30 20
 LW100 control LW101 display number
 0 3

2. Change Y high limit to 100 for zoom out effect.

XL XH YL YH
 0 50 0 100
 XY XY1 XY2
 5 1 10 45 30 20
 LW100 control LW101 display number
 0 3

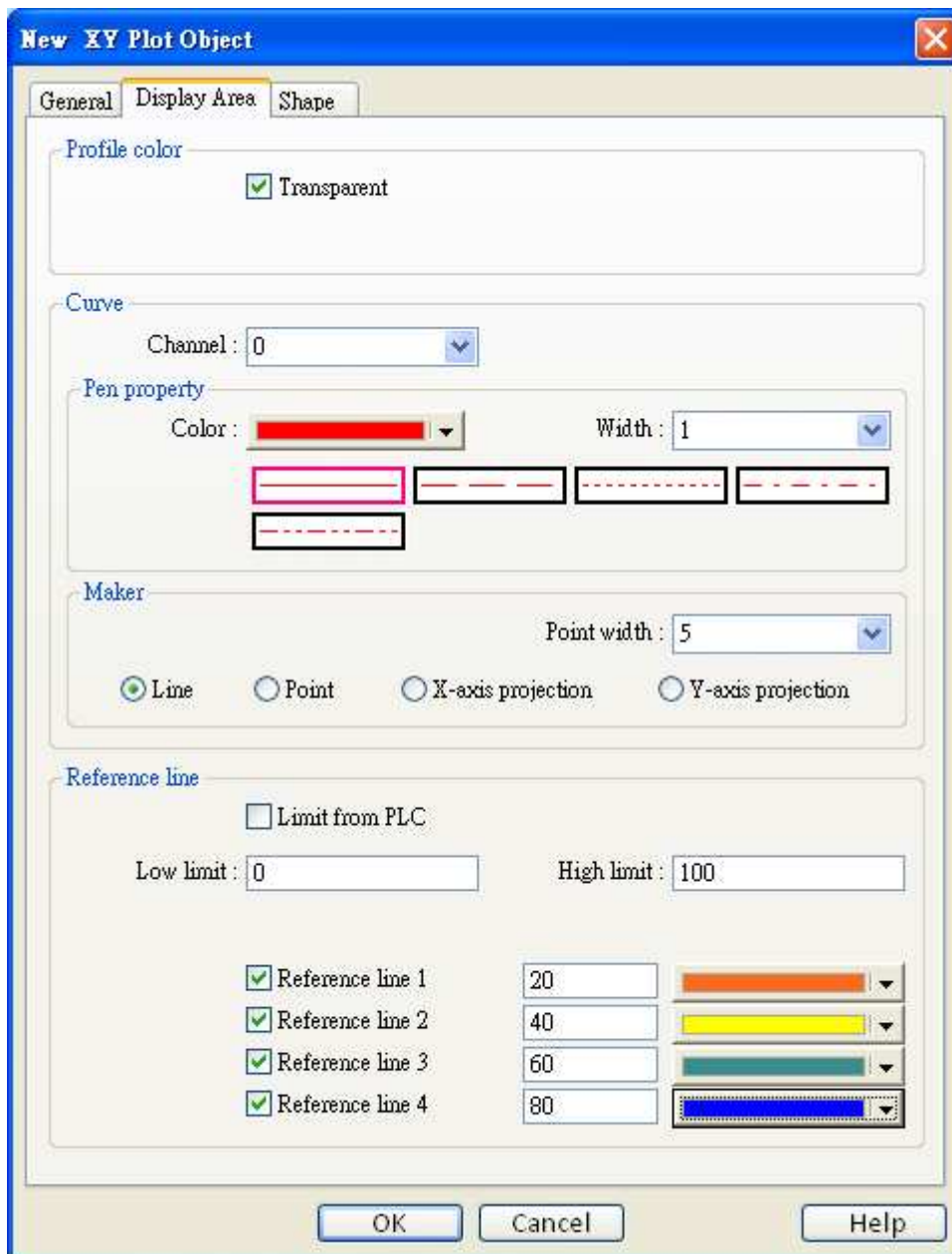
[Display Area tab]

Setting	Description
Profile color	Enable Transparent: It will not display the background color. Disable Transparent: It will display the background color
Curve	Set the attribute of XY curve (color and width) for each channel.

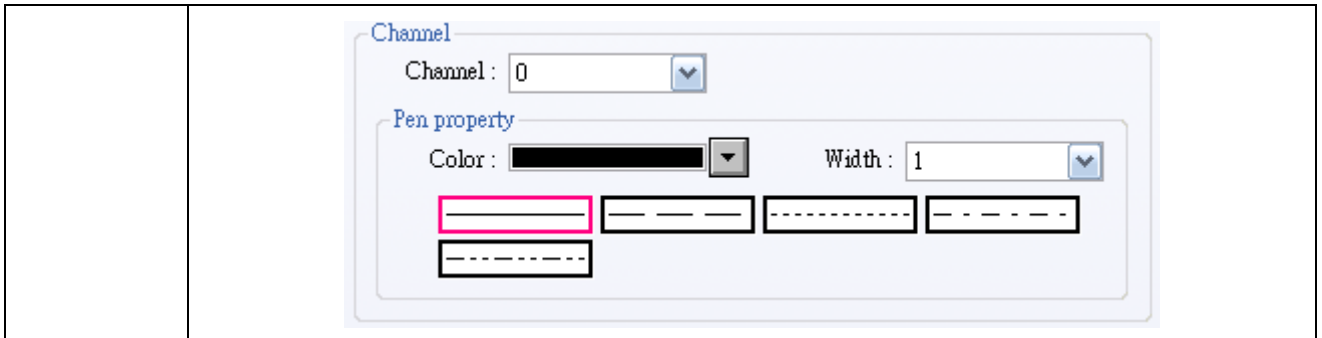

Maker

There are four different type of XY plot, i.e. Line, Point, X-axis projection and Y-axis projection, check one of them.

For Line and Point selection, set appropriate point width (unit in pixels).

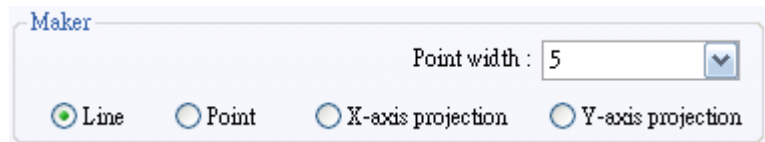

Line & Point:

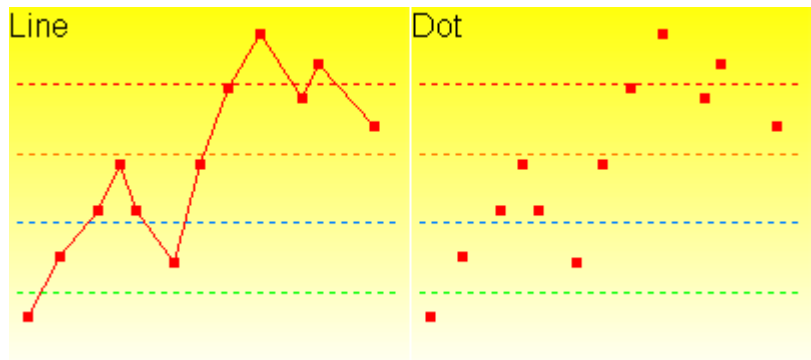

X-axis projection is shown as the following:

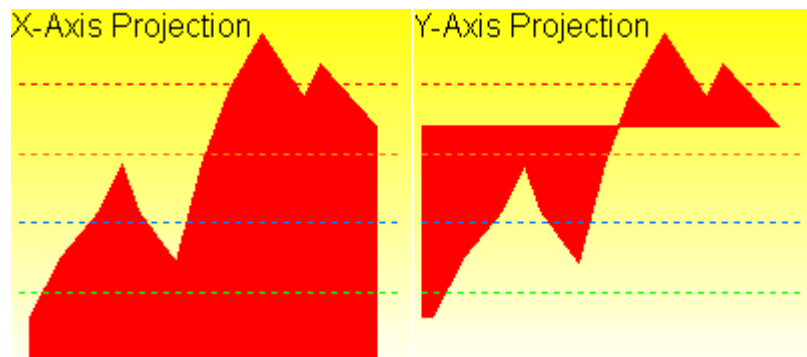

Remarks:

Please refer to the figure below, there is a curve containing 7 points from P0

to P6. The system carries out X-axis projection with following steps:

- Automatically calculate two projected points in X-axis – $(X_0, 0)$ and $(X_6, 0)$.
- Link all these points in the order of $(X_0, 0)$, P0, P1... P6, $(X_6, 0)$ and returns to $(X_0, 0)$ at last.
- Fill out all enclosed areas formed.

X-axis projection :

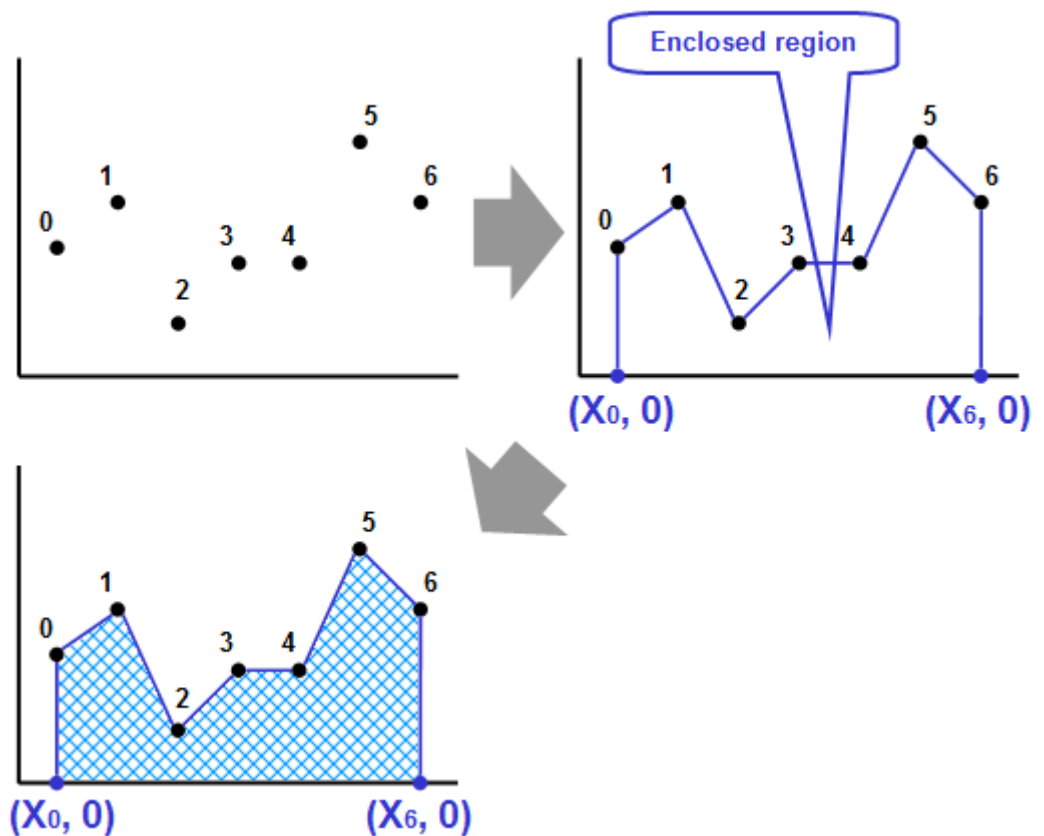

Similarly for Y-axis projection:

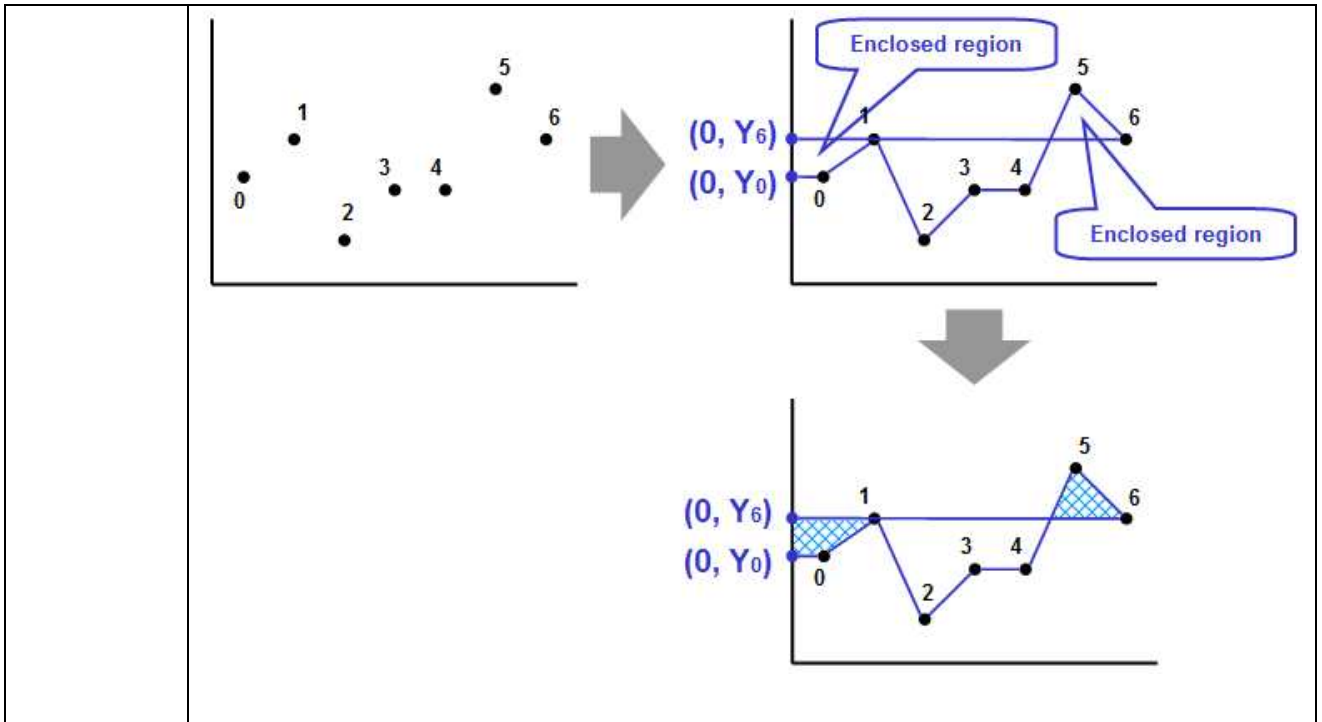

Reference line

In order to make the XY plot more readable, you can configure up to 4 horizontal reference lines on the graph. Fill in high, low limit and Y axis coordinate for each reference line.

Reference line

Limit from PLC

Limit

Low limit : High limit :

<input checked="" type="checkbox"/> Reference line 1	<input type="text" value="20"/>	<input type="color" value="green"/>	<input type="button" value="v"/>
<input checked="" type="checkbox"/> Reference line 2	<input type="text" value="40"/>	<input type="color" value="blue"/>	<input type="button" value="v"/>
<input checked="" type="checkbox"/> Reference line 3	<input type="text" value="60"/>	<input type="color" value="orange"/>	<input type="button" value="v"/>
<input checked="" type="checkbox"/> Reference line 4	<input type="text" value="80"/>	<input type="color" value="red"/>	<input type="button" value="v"/>

You may also use PLC address to define high and low limit.

Reference line

Limit from PLC

PLC name : Local HMI Setting...

Address : LW 0 16-bit Unsigned

Reference line 1 20

Reference line 2 40

Reference line 3 60

Reference line 4 80

Note:

XY Plot can be drawn repeatedly up to 32 times:

1 channel → 32 times

2 channels → 16 times

The way to calculate: 32 divided by the number of channels

13.21 Alarm Bar and Alarm Display

Overview

Alarm bar and Alarm display objects are used to display alarm messages. Alarm messages are those events registered in the “Event log” and meet trigger conditions. Alarm bar and Alarm display objects display these alarms in order of priority and triggering time.

Alarm bar object scroll all alarm messages in one line, alarm display object displays alarm messages in multi-line and each line represents one alarm message. The following pictures show that the alarm message are displayed in alarm display and alarm bar objects. Refer to the “Event Log” chapter for related information.



Alarm bar object

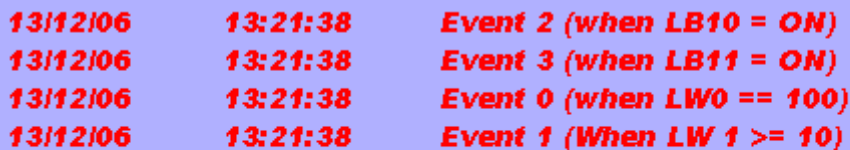

Alarm display object

Configuration

Click the “Alarm bar” icon on the toolbar, the “Alarm bar” dialogue box appears; similarly, click the “Alarm display” icon on the toolbar, the “Alarm display” dialogue box appears, fill in the setting in the “General tab” and press the OK button, a new object will be created. See the pictures below.

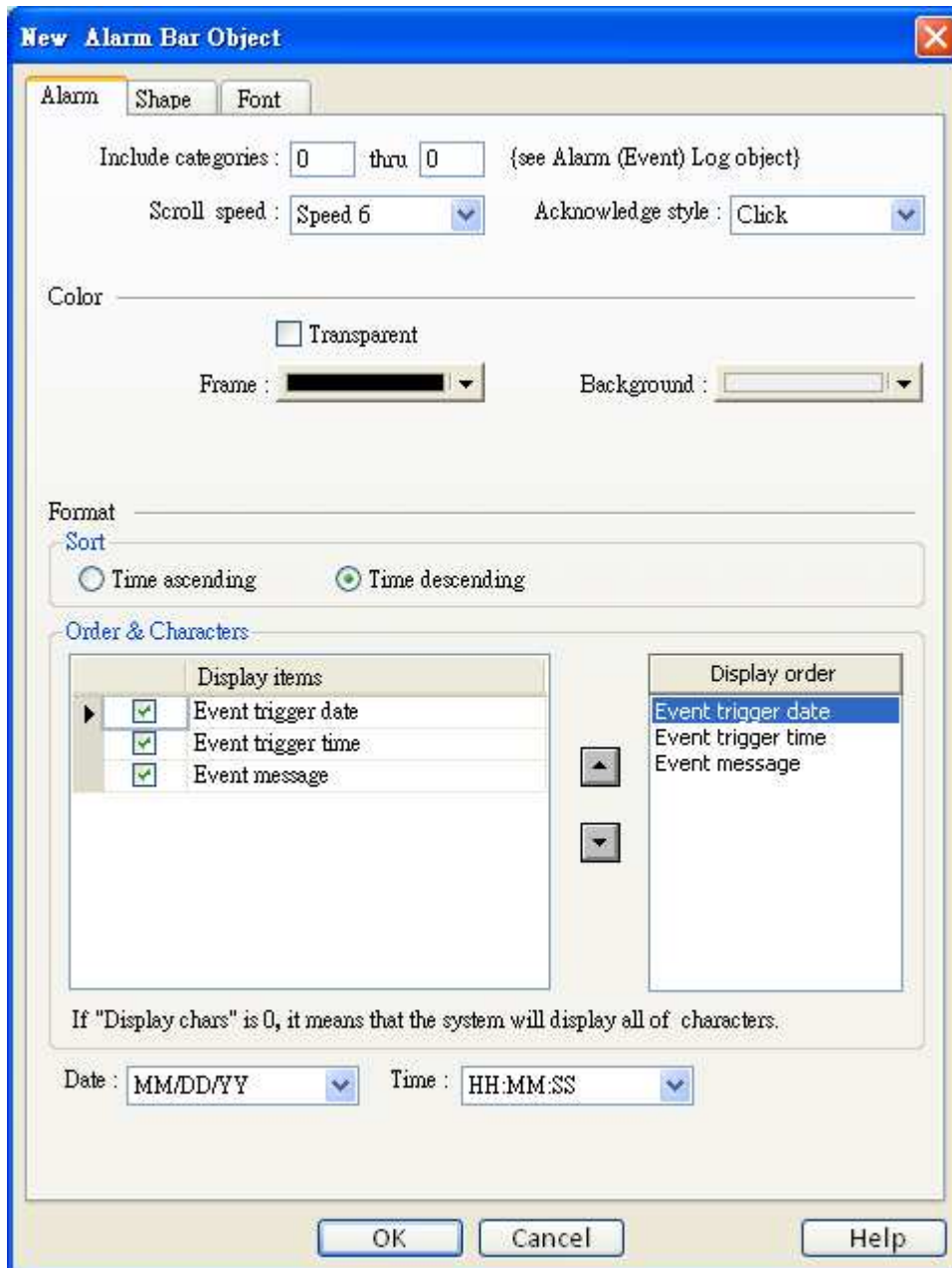
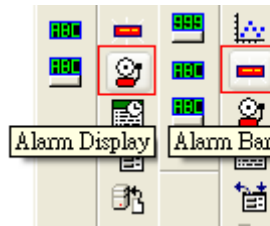

Setting	Description
Include categories	Select category of events that belongs to the alarm display or alarm bar object. (category of an event is set in event log)

	<p>For example, if the category of an alarm bar is set to 2~4, it will display all the alarm messages with “category” equal to 2, 3, or 4.</p> <p>Please refer to “Category” statement in “Event Log” chapter.</p>
Scroll Speed	Set the scroll speed of alarm bar.
Color	Set frame and background color of alarm bar.
Format	<p>a. Sort</p> <p>Set the order to display alarm message.</p> <p>[Time ascending] Put the latest trigger alarm message in the bottom.</p> <p>[Time descending] Put the latest trigger alarm message in the top.</p>
	<p>b. Order & Characters</p> <p>Users can decide the display item, and how the item display order.</p>
	<p>c. Date (Event trigger date)</p> <p>Display the date tag with alarm message. There are four formats of date tag.</p> <p>1. MM/DD/YY / 2. DD/MM/YY / 3. DD.MM.YY / 4. YY/MM/DD</p>
	<p>d. Time (Event trigger time)</p> <p>Display the time tag with alarm message. There are three formats of time tag.</p> <p>1. HH:MM:SS / 2. HH:MM / 3. DD:HH:MM / 4. HH</p>

Set font and color of alarm message in the “Font” tab. See the picture below.

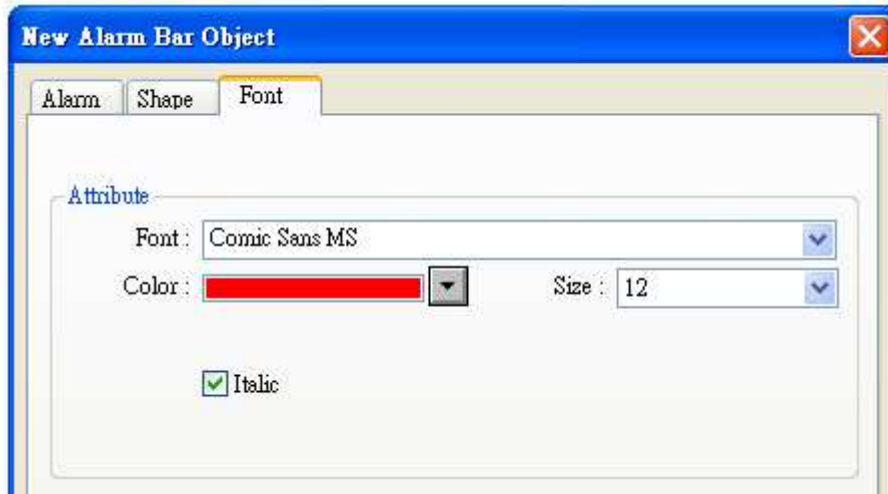

13.22 Event Display

Overview

Event display object displays active and finished events. The events are registered in “Event log” object. The active events are the events which are in trigger condition, or have been triggered and unacknowledged.

The event display object displays those active events in the order of trigger time. See the picture below. Event display object can also display the time of the events been triggered, acknowledged and recovered.



18	01/20/09	15:35:22		Event 1 (LB10 = ON)
17	01/20/09	15:35:22		Event 0 (LB0=ON)
16	01/20/09	15:35:20	15:35:23	Event 3 (LW20 <= 5)
15	01/20/09	15:35:19		Event 0 (LB0=ON)
14	01/20/09	15:35:18		Event 1 (LB10 = ON)
13	01/20/09	15:35:15	15:35:16	Event 2

Configuration

Click the “Event Display” icon on the toolbar, the “Event Display” dialogue box appears, set each items in the “General” tab, press OK button and a new “Event Display Object” will be created. See the pictures below.

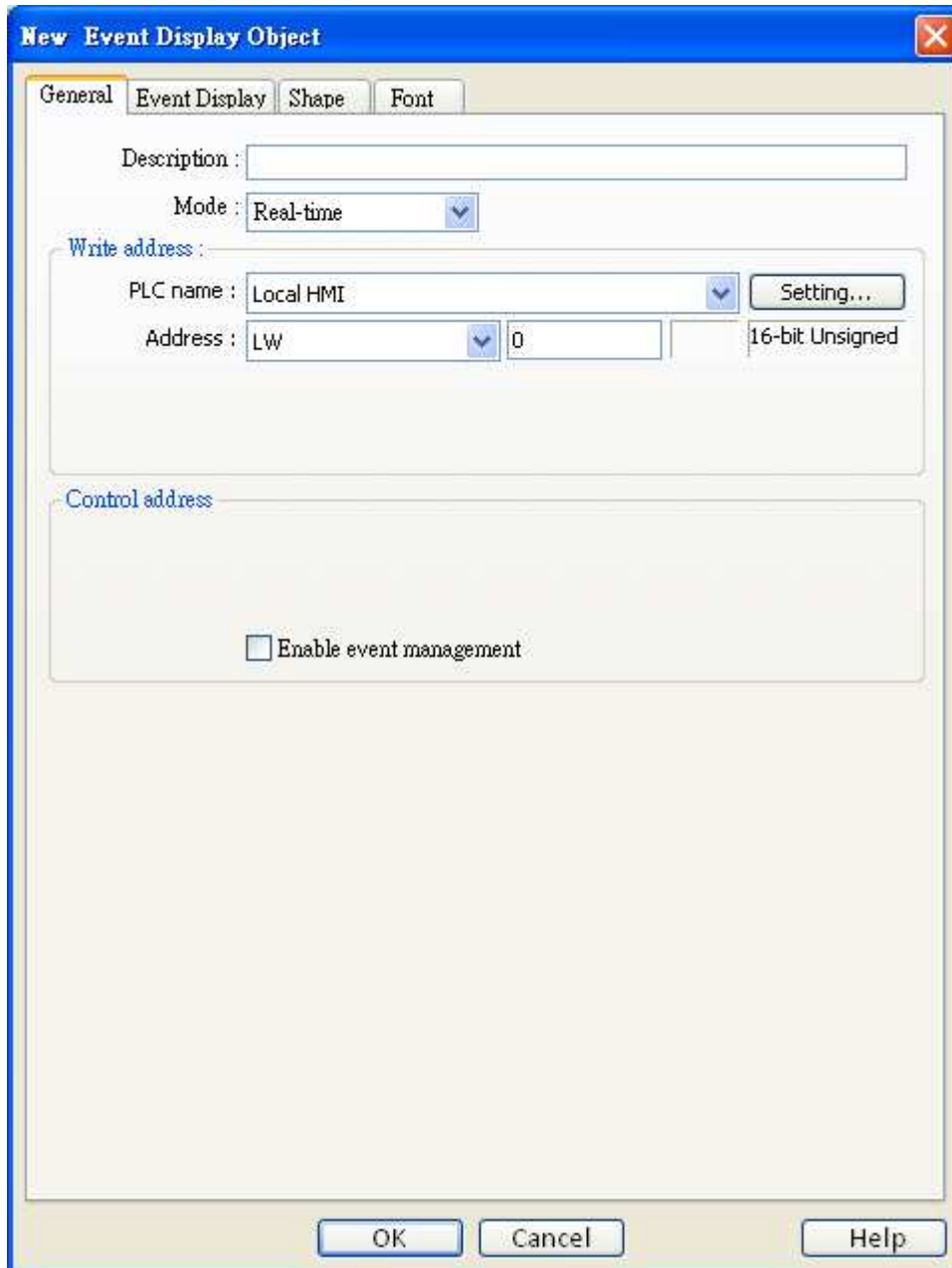

Setting	Description
[Mode]	Select the event source format, there are “Real-time” and “History” for selection.
	<p>a. Real-time</p> <p>Write address This displays the events in the log triggered from HMI starts up till present. When the events are acknowledged, the value in [Alarm (Event) Log]/ [Message]/ [Write value for Event Display object] will</p>

be exported to the [write address] of [event display] object.

b. History Control

- [Enable reading multiple histories] **not** selected.

In this mode it displays event log from history record. The system save the event history in daily basis. The event history of each date is saved in separated files with date tags attached. The “History control” is used to select one history record file.

The picture below shows the “History control” setting, which designates a word device for “History control”.

The system selects history record by an index. Index 0 refers to the latest history record (normally it is history record today). Index 1 refers to the history record one day before the latest, and so on.

The current value in “History control” register is used as the index to select corresponding history record.

Here is an example to explain how to use “History control”. The “history control” register is [LW100], supposed that the history records saved in system are

- EL_20061120.evt,
- EL_20061123.evt,
- EL_20061127.evt
- EL_20061203.evt,

Where 2006xxxx is the date of system saved history record. The following table shows the corresponding historical record displayed be event display object according to the value of [LW100].

Value of [LW100]	Corresponding Historical Record
0	EL_20061203.evt

1	EL_20061127.evt
2	EL_20061123.evt
3	EL_20061120.evt

- [Enable reading multiple histories] selected.

Definition: Displays a list of events triggered in multiple days.

Illustration: Take LW0 to be the **[History Control] [Address]** as an example, the range of data to be displayed will be formed by LW0 and LW1 while value in LW0 represents the first history data to start with.

Example: As illustrated below, for showing it clearer, the history data is numbered according to the date they are established,

(No.0、No.1、No.2...). If the value in LW0 is “3”, the first data to be displayed will be data No. 3.

EL_20100604	No.4	1 KB	EVT 檔案
EL_20100605	No.3	6 KB	EVT 檔案
EL_20100608	No.2	17 KB	EVT 檔案
EL_20100609	No.1	4 KB	EVT 檔案
EL_20100610	No.0	12 KB	EVT 檔案

As for LW1, 2 modes can be selected.





a. Number of days



The range of History Data to be displayed will start from number in LW0. The value in LW1 represents how many days to be included from the start to days before.

Example: As illustrated below, if value of LW0 is “1”, LW1 is “3”, then the range of data will start form 20100609, and include data of 2 days before (while 20100609 itself is counted). We can see

that in this example, since data of 20100607 does not exist, the data displayed will only include 20100609 and 20100608.





 EL_20100604	No.4	1 KB	EVT 檔案
 EL_20100605	No.3	6 KB	EVT 檔案
 EL_20100608	No.2	17 KB	EVT 檔案
 EL_20100609	No.1	4 KB	EVT 檔案
 EL_20100610	No.0	12 KB	EVT 檔案

b. Index of the last history



Range of data to be displayed will take value in LW0 as a start point and value in LW1 as an end.

Example: if value in LW0 is “1”, and LW1 “3”, the displayed data will start from No. 1, and include 3 history data (No.1, No.2, No.3).

 EL_20100604	No.4	1 KB	EVT 檔案
 EL_20100605	No.3	6 KB	EVT 檔案
 EL_20100608	No.2	17 KB	EVT 檔案
 EL_20100609	No.1	4 KB	EVT 檔案
 EL_20100610	No.0	12 KB	EVT 檔案

The maximum size of data that can be displayed by system is 4MB; the exceeding part will be ignored.

The following shows how data will be stored while the data size is too big.

Example:

- a. 5 history data, each with a size of 0.5MB → The size of data to be displayed will be 5 x 0.5MB
- b. 5 history data, each with a size of 1MB → The size of data to be displayed will be 4 x 1MB
- c. 5 history data, each with a size of 1.5MB → The size of data to be displayed will be 2 x 1.5MB+1 x 1MB (partial)

Definition:

- 1. To select confirmed or recovered events to be displayed

or hidden.

2. In **[Real-time]** mode, select events to be deleted.

Illustration:

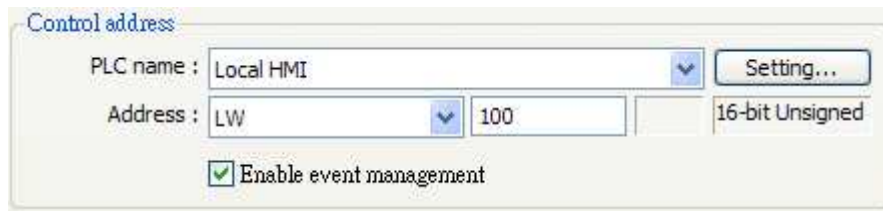

Control address

PLC name : Local HMI ▼ Setting...

Address : LW ▼ 100 16-bit Unsigned

Enable event management

If the address of History control is set LW100:

1. When the value in [LW100+0] is "0" → All events will be displayed.
2. When the value in [LW100+0] is "1" → The confirmed events will be hidden.
3. When the value in [LW100+0] is "2" → The recovered events will be hidden.
4. When the value in [LW100+0] is "3" → The confirmed and recovered events will be hidden.
5. When the value in [LW100+1] is "1" → Users can delete the selected events under [real-time] mode.

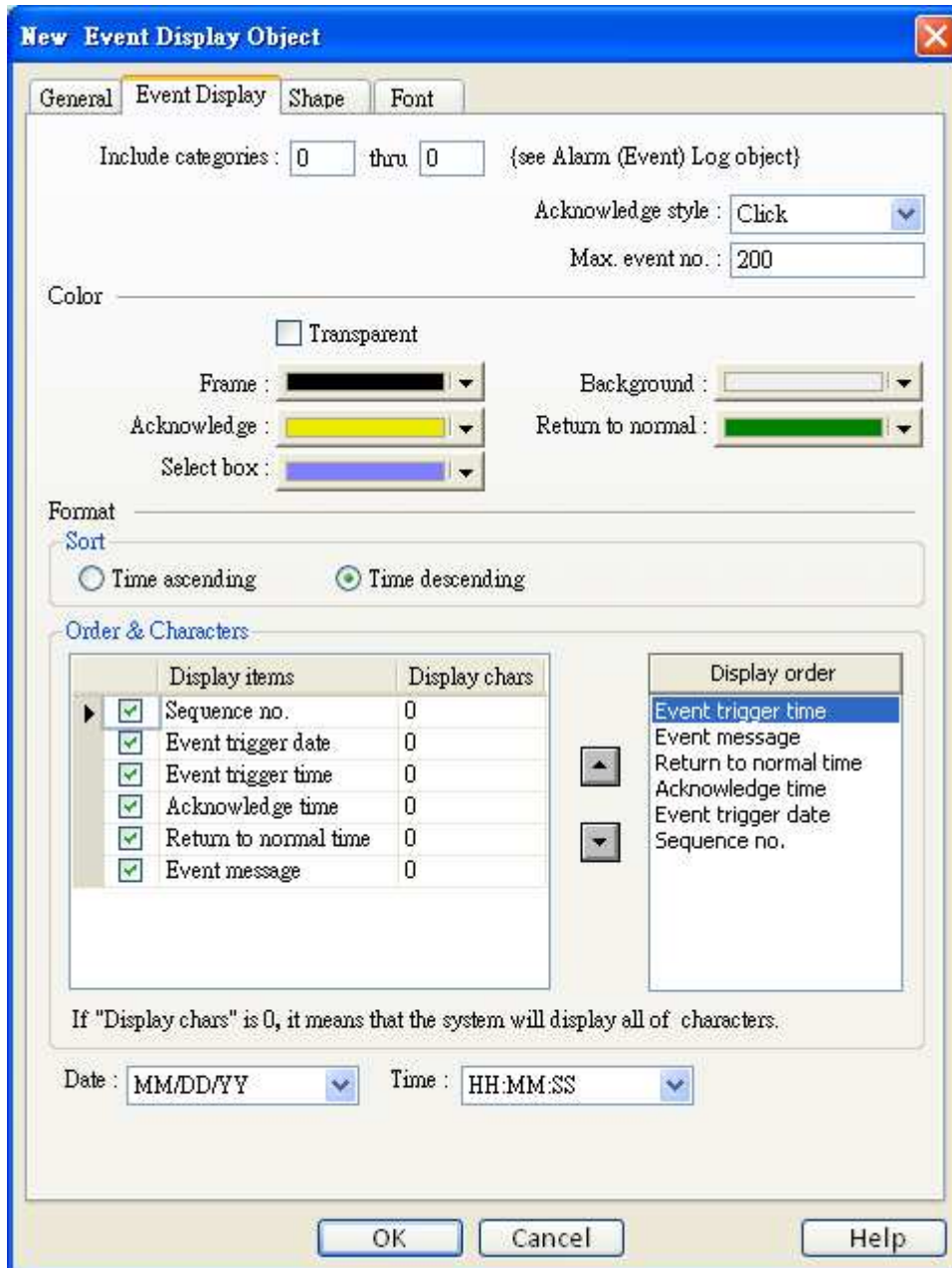

New Event Display Object

General | **Event Display** | Shape | Font

Include categories : 0 thru 0 (see Alarm (Event) Log object)

Acknowledge style : Click

Max. event no. : 200

Color

Transparent

Frame : [Black]

Acknowledge : [Yellow]

Select box : [Blue]

Background : [White]

Return to normal : [Green]

Format

Sort

Time ascending Time descending

Order & Characters

Display items	Display chars
<input checked="" type="checkbox"/> Sequence no.	0
<input checked="" type="checkbox"/> Event trigger date	0
<input checked="" type="checkbox"/> Event trigger time	0
<input checked="" type="checkbox"/> Acknowledge time	0
<input checked="" type="checkbox"/> Return to normal time	0
<input checked="" type="checkbox"/> Event message	0

Display order



- Event trigger time
- Event message
- Return to normal time
- Acknowledge time
- Event trigger date
- Sequence no.

If "Display chars" is 0, it means that the system will display all of characters.

Date : MM/DD/YY Time : HH:MM:SS

OK Cancel Help

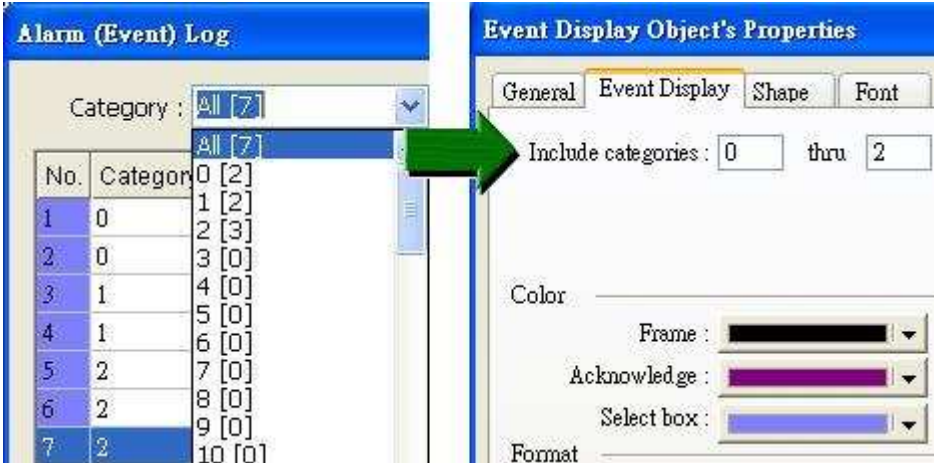
Setting	Description
Include categories	<p>Select category of events that belongs to the event display object. (category of an event is set in event log)</p> <p>For example, if the category of an event log display is set to 2~4, it will display all the active event messages with "category" equal to 2, 3, or 4.</p> <p>Please refer to "Category" statement in "Event Log" chapter.</p>

	
<p>Acknowledge style</p>	<p>You may select “Click” or “Double click” to acknowledge a new event. When a new event comes up, the operator can “Click” or “Double click” to acknowledge the new event, the system will change the text color of that event and export the “write value” registered with the event to the designated register.</p> <p>Take use of this feature, the user can register a popup window and put the warning message in the window, then configure an indirect window object, when the event is acknowledged, the “write value” is written into the read address of the indirect window and call up the popup window.</p>
<p>Max. event no.</p>	<p>The maximum number of events to be displayed in the event display object. When the number of events is larger than the maximum, the oldest event will be removed from the event display object.</p>
<p>Color</p>	<p>Set the color of events in different states.</p> <ul style="list-style-type: none"> a. Acknowledge b. Return to normal c. Select box – The system draw a highlight box around the latest acknowledged event. 

Format	<i>trigger date</i> <i>trigger time</i> <i>notification time</i> <i>return to normal time</i>																		
	<table border="1" style="width: 100%; border-collapse: collapse;"> <tr> <td style="text-align: center;">0</td> <td style="text-align: center;">12/14/06</td> <td style="text-align: center;">15:26:21</td> <td style="text-align: center;">15:26:31</td> <td style="text-align: center;">15:26:36</td> <td style="text-align: left;">Event 0 (when LV</td> </tr> <tr> <td style="text-align: center;">1</td> <td style="text-align: center;">12/14/06</td> <td style="text-align: center;">15:26:47</td> <td style="text-align: center;">15:26:50</td> <td></td> <td style="text-align: left;">Event 1 (When LV</td> </tr> <tr> <td style="text-align: center;">2</td> <td style="text-align: center;">12/14/06</td> <td style="text-align: center;">15:26:48</td> <td></td> <td></td> <td style="text-align: left;">Event 2 (when LE</td> </tr> </table>	0	12/14/06	15:26:21	15:26:31	15:26:36	Event 0 (when LV	1	12/14/06	15:26:47	15:26:50		Event 1 (When LV	2	12/14/06	15:26:48			Event 2 (when LE
0	12/14/06	15:26:21	15:26:31	15:26:36	Event 0 (when LV														
1	12/14/06	15:26:47	15:26:50		Event 1 (When LV														
2	12/14/06	15:26:48			Event 2 (when LE														
	<p>a. Sort</p> <p>Set the order to display alarm message.</p> <p>[Time ascending]</p> <p>Put the latest trigger alarm message in the bottom.</p> <p>[Time descending]</p> <p>Put the latest trigger alarm message in the top.</p>																		
	<p>b. Order & Characters</p> <p>Users can decide the display item, and how the item display order.</p>																		
	<p>c. Date [Event trigger date]</p> <p>Display the date tag with alarm message. There are four formats of date tag.</p> <p>1. MM/DD/YY / 2. DD/MM/YY / 3. DD.MM.YY / 4. YY/MM/DD</p>																		
	<p>d. Time [Event trigger time]</p> <p>Display the time tag with alarm message. There are three formats of time tag.</p> <p>1. HH:MM:SS / 2. HH:MM / 3. DD:HH:MM / 4. HH</p>																		

The font tab sets the font size and italic attribute. The font of event message is set with the event log object.

13.23 Data Transfer (Trigger-based)

Overview

Data Transfer (Trigger-based) object can transfer values from the source registers to the destination registers. The data transfer operation can be activated by pressing the object or setting a trigger bit.

Configuration

Click “Data Transfer (Trigger-based) object” icon on the toolbar, “Data Transfer (Trigger-based) object” dialogue box will show up, set each item in the “General” tab, press OK button, a new Trigger Data Transfer object will be created. See the picture below.

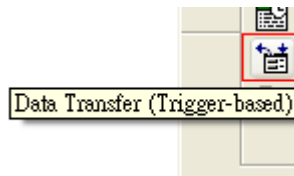

New Data Transfer (Trigger-based) Object

General Security Shape Label

Description :

Source address

PLC name : Local HMI

Address : LW

Destination address

PLC name : Local HMI

Address : LW

Attribute

No. of word :

Mode : External trigger Trigger mode : ON->OFF

Touch trigger

External trigger

Trigger address

PLC name : Local HMI

Address : LB

OK Cancel Help

Setting	Description
Source address	Set source address of data transfer. Click [Setting...] to Select the [PLC name] , [Device type] , [Address] , [System tag] , [Index register] of Source address. Users can also set address in General tab while adding a new object
Destination address	Set the destination address of data transfer. Click [Setting...] to Select the [PLC name] , [Device type] , [Address] , [System tag] , [Index register] of Destination

	<p>address.</p> <p>Users can also set address in General tab while adding a new object</p>
Attribute	<p>[No. of words]</p> <p>The number of words to be transferred from source to destination.</p> <p>Set the trigger mode of data transfer.</p>
	<p>[Mode]</p> <p>a. Touch trigger Press the object to activate data transfer operation.</p> <p>b. External trigger Register a bit device to trigger the data transfer operation.</p> <p>[ON → OFF] Bit device change from ON to OFF to activate data transfer operation.</p> <p>[OFF → ON] Bit device change from OFF to ON to activate data transfer operation.</p> <p>[ON ↔ OFF] Bit device change state to activate data transfer operation.</p> <div data-bbox="443 1518 1337 1814" style="border: 1px solid #ccc; padding: 10px; margin-top: 20px;"> <p>Attribute</p> <p>No. of word : <input type="text" value="1"/></p> <p>Mode : <input type="text" value="External trigger"/> <input type="button" value="v"/></p> <p>Trigger mode : <input type="text" value="ON->OFF"/> <input type="button" value="v"/></p> <hr/> <p>Trigger address</p> <p>PLC name : <input type="text" value="Local HMI"/> <input type="button" value="v"/> <input type="button" value="Setting..."/></p> <p>Address : <input type="text" value="LB"/> <input type="button" value="v"/> <input type="text" value="0"/> <input type="text"/></p> </div>

13.24 Backup

Overview

The backup function can store the recipe data (RW, RW_A), event log and sampling data to USB device or Remote backup server. The [LB-9039] represents the backup status, when backup operation is in progress, the status of [LB-9039] is ON.

Configuration

Click “Backup Object” icon on the toolbar, the “Backup Object” dialogue box will show up. See the pictures below.

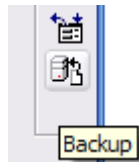

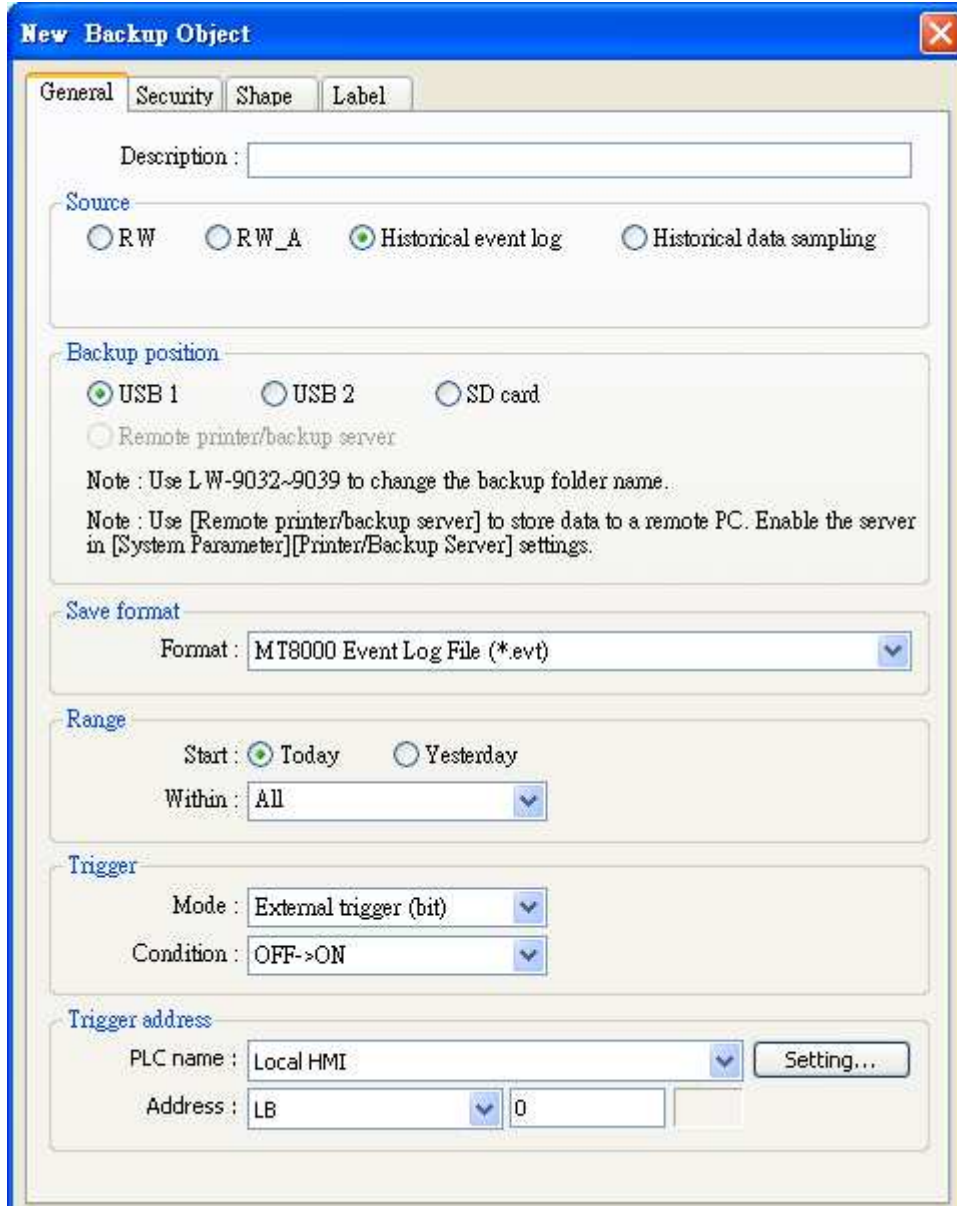

New Backup Object

General Security Shape Label

Description :

Source

RW RW_A Historical event log Historical data sampling

Backup position

USB 1 USB 2 SD card

Remote printer/backup server

Note : Use L W-9032~9039 to change the backup folder name.

Note : Use [Remote printer/backup server] to store data to a remote PC. Enable the server in [System Parameter][Printer/Backup Server] settings.

Save format

Format :

Range

Start : Today Yesterday

Within :

Trigger

Mode :

Condition :

Trigger address

PLC name :

Address :

Setting	Description
Source	<p>[RW], [RW_A], [Historical event log], [Historical data sampling]</p> <p>Select one from the above for the source. There may be several data sampling objects registered in the project. If you select [Historical data log], use “Data Sampling object index:” to select the right one as shown below.</p>

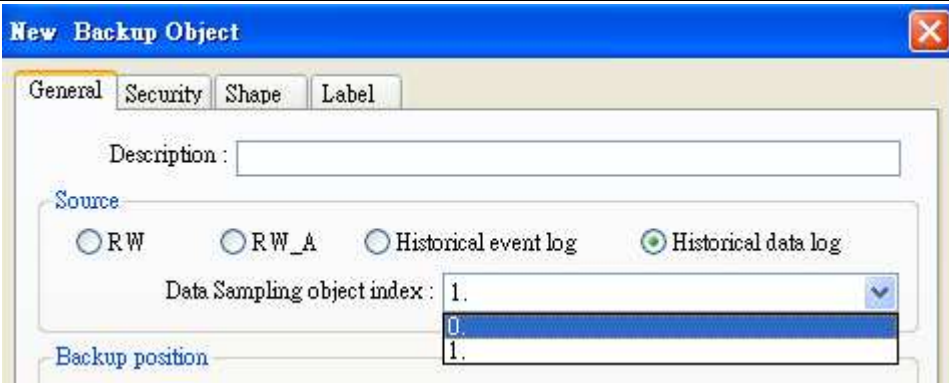
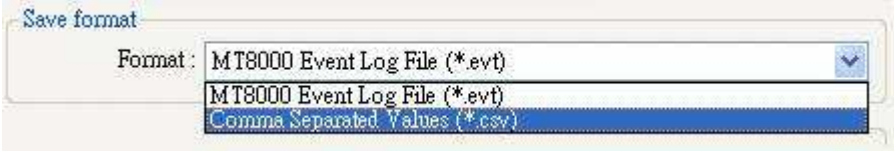
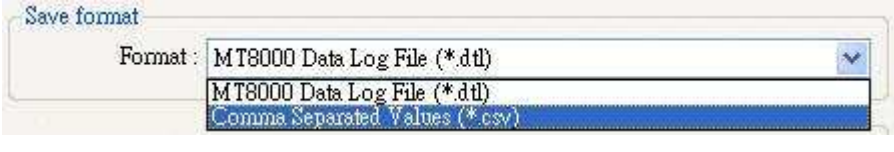
	
Backup Position	<p>Select the destination where the source files will be copied to.</p> <ol style="list-style-type: none"> a. USB1 or USB2 or SD card The external device connected to HMI. b. Remote printer/backup server To select this, users have to enable <i>MT remote printer/backup server</i> from: Menu ⇒ Edit ⇒ System Parameters ⇒ Printer/Backup Server
Save format	<p>User can select the desired format to back up the file.</p> <ol style="list-style-type: none"> a. MT8000 Event Log File (*.evt) / MT8000 Data Log File (*.dtl) b. Comma Separated Values (*.csv) <ul style="list-style-type: none"> ➤ Event Log saved as csv file  <ol style="list-style-type: none"> ➤ Data Log saved as csv file  <p>When back up event log in csv format, users can find data fields in EXCEL as below.</p>

	A	B	C	D	E
1	[Creation time]				
2	Fri Oct 29 10:59:28 2010				
3	[Data fields]				
4	event	category	time	message	
5	[Data]				
6	0	0	11:19:42	"Emergency"	
7	0	5	11:19:43	"5"	
8	2	0	11:19:46	"LOW"	
9	2	5	11:19:49	"5"	
10	1	0	11:19:52	"Word"	
11	2	0	11:19:52	"Word"	
12					
13					
14					

- 0 -> event is triggered
- 1 -> event is acknowledged
- 2 -> event returns to normal

Range

[Start] from **[Today]** or **[Yesterday]**

[Within]

Select the range of time period, for example, Select [Yesterday] in [Start], and select "2 day(s)". It means to save the files yesterday and the day before yesterday. Select "All" to save all the files available in the system.

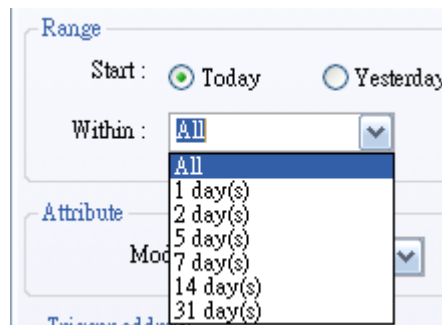

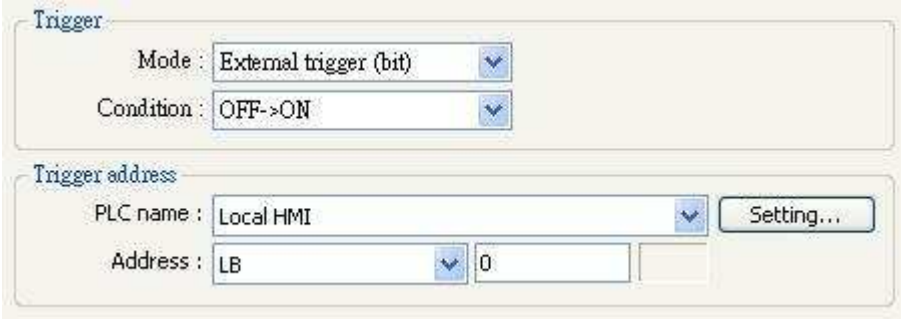
Attribute	<p>There are two ways to activate Backup function.</p> <p>a. Touch trigger Touch the object to activate backup operation.</p> <p>b. External trigger (bit) Register a bit device to trigger the backup operation.</p> <p>[ON → OFF] Bit device change from ON to OFF to activate backup operation.</p> <p>[OFF → ON] Bit device change from OFF to ON to activate backup operation.</p> <p>[ON ↔ OFF] Bit device change state to activate backup operation.</p> <p>Trigger address When use “External trigger”, assign an appropriate bit device as shown below.</p> <div data-bbox="416 1173 1321 1491"></div> <p>c. External trigger (word) When selecting [External trigger (word)], users can specify the number of days to backup data using [Trigger address].</p>
------------------	---

The screenshot shows a configuration window with two main sections. The top section, titled 'Trigger', contains a 'Mode' dropdown menu set to 'External trigger (word)' and a 'Syntax...' button. The bottom section, titled 'Trigger address', contains a 'PLC name' dropdown menu set to 'Local HMI' with a 'Setting...' button, and an 'Address' field with a dropdown menu set to 'LW' and a text input field containing '0'.

[Trigger address] usage (suppose the current Trigger Address is set to LW-0) :

LW-0: When the value of this address changes from 0 to 1, trigger backup.

LW-1: The data in this address is for specifying the start date of backup.

LW-2: The data in this address is for specifying the number of days for backup.

The Syntax is shown below:

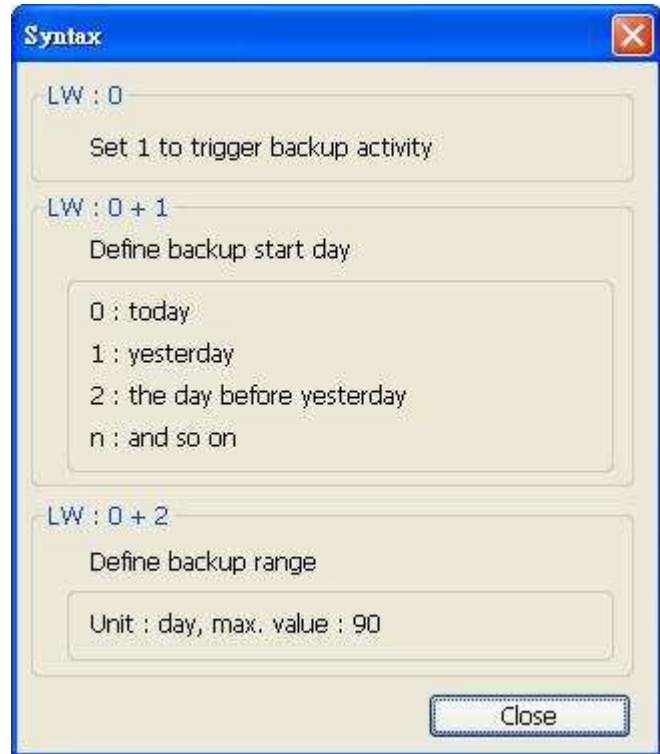

The screenshot shows a dialog box titled "Syntax" with a close button in the top right corner. The dialog contains three sections of text:

- LW : 0**
Set 1 to trigger backup activity
- LW : 0 + 1**
Define backup start day
0 : today
1 : yesterday
2 : the day before yesterday
n : and so on
- LW : 0 + 2**
Define backup range
Unit : day, max. value : 90

A "Close" button is located at the bottom right of the dialog box.

13.25 Media Player

For the first time using Media Player object, it's necessary to download the project to the HMI **via Ethernet**. EasyBuilder8000 will install Media Player drivers during the download.

Overview

The Media Player function is not only used to play video files but also to provide uses of additional controls such as seeking, zooming, volume adjusting and so on. With the Media Player, users can provide operation and maintenance instructions or standard procedures on video, which can help to create an environment that enables any on-site operators to perform tasks efficiently from clear, comprehensible instructions. (Note: The Media Player function is only available on the MT8000X Series models.)

Configuration

Click "Media Player object" icon on the toolbar, "Media Player object" dialogue box show up, set each item in the "General" tab, press OK button, a new Media Player object will be created. See the pictures below. (Note: The instruction of this section is an example to play a video file located in the "/example" directory.)

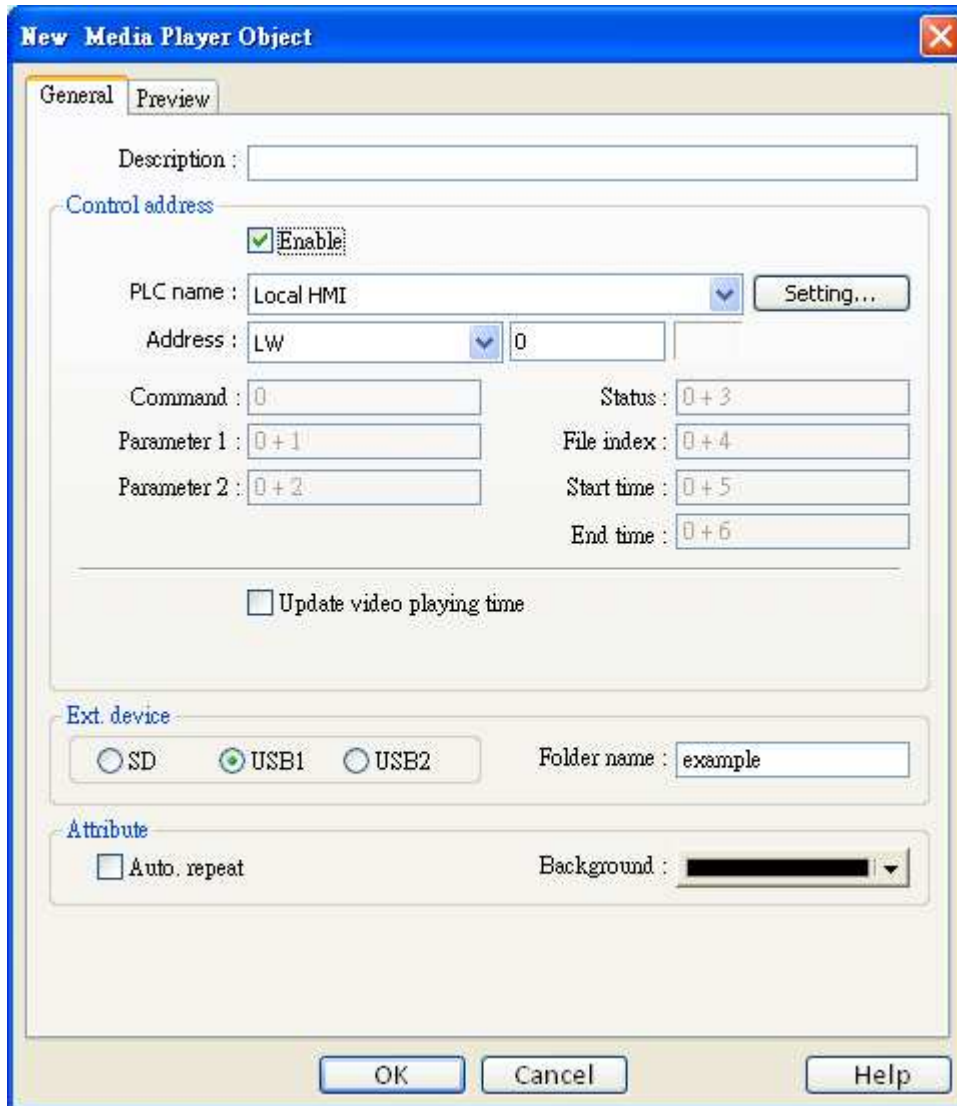

**General tab :**

Click [Setting...] to Select the **[PLC name]**, **[Device type]**, **[Address]**, **[System tag]**, **[Index register]** of Control address.

Users can also set address in General tab while adding a new object.

- a. In [Control address], select [Enable] and register a word device to control the operation of media player object (example : LW0)

Control address

Enable

PLC name : Local HMI Setting...

Address : LW 0

Command : 0 Status : 0 + 3

Parameter 1 : 0 + 1 File index : 0 + 4

Parameter 2 : 0 + 2 Start time : 0 + 5

End time : 0 + 6

- b. In [Control address], unselect the [Update video playing time]

Update video playing time

- c. In [Ext. device], select [USB1] and input “**example**” as [Folder name].

Ext. device

SD USB1 USB2

Folder name : example

- d. In [Attribute], unselect [Auto. repeat] and choose black as the background color.

Attribute

Auto. repeat

Background :

Preview tab :

Users can examine whether the MT8000 supports the video format via preview function.



- a. Click [Load...] and select the file to be examined. (Users should put the file in the */example* directory of an USB disk)
- b. If the media player starts playing the video, it means the MT8000 supports this video format. Use [<<] and [>>] to navigate video by 1 minute each time.
- c. To play another video, click [Stop] to close the video file and repeat from step a.

Prepare the video file:

- a. Remove all external devices (SD/USB disk) connected to the MT8000.
- b. Plug the USB disk, which has the video file in it, into the MT8000.

Note

The first step is there for ensuring the USB disk (in step b) will be recognized as USB1.

Start/Stop playing video

1. Start playing video

- a. Set [Parameter 1] to 0.
 - b. Set [Command] to 1, the system will open the video file and start playing.
 - c. After the system start operation, it will reset the [Command] to "0".
-

Note

During the period between step b and c, don't change the content of [Command], [Parameter 1], and [Parameter 2], it may cause unpredictable result.

2. Stop playing video

- a. Set [Command] to 5, the system will stop playing and close the video file.
 - b. After the system complete step a, it will reset the [Command] to "0".
-

Note

During the period between step a and b, don't change the content of [Command], [Parameter 1], and [Parameter 2], it may cause unpredictable result.

Media player setting guide

General tab :

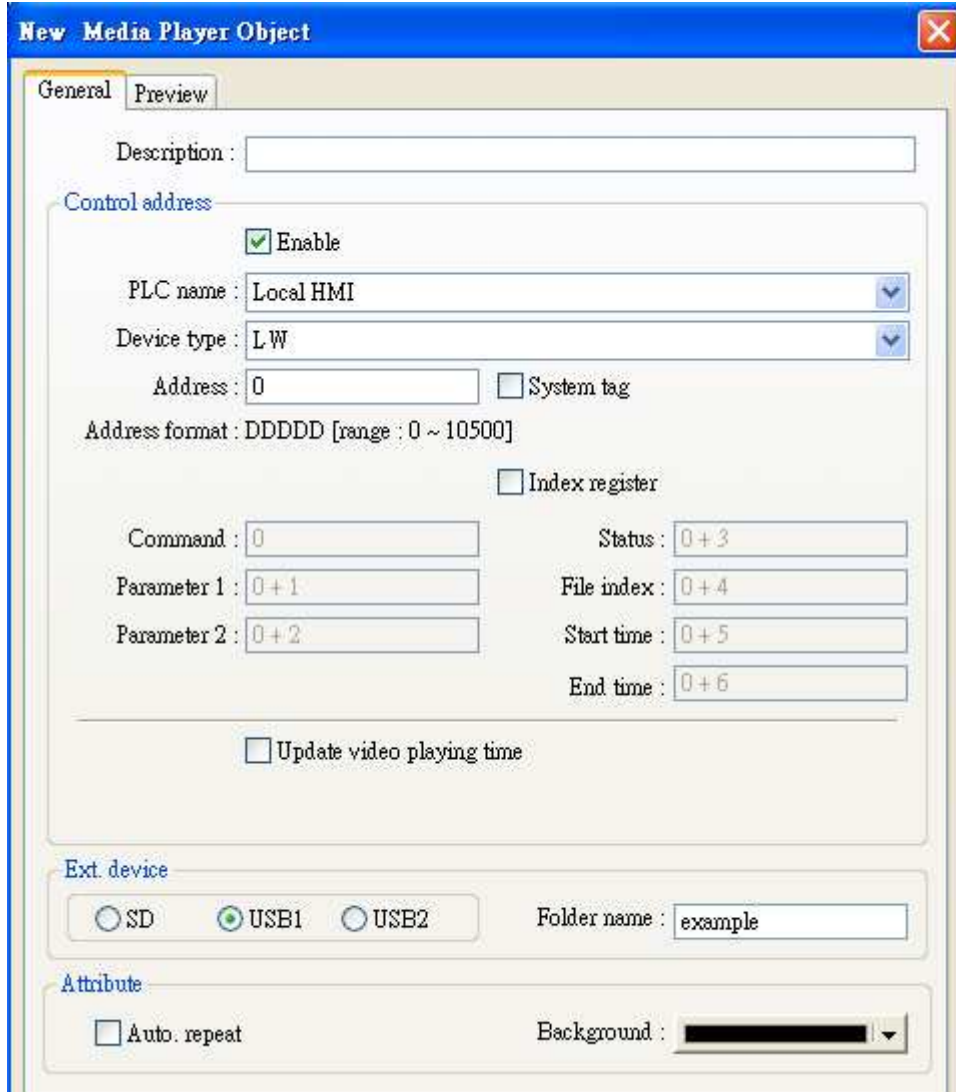

Setting		Description
Control address	Enable control address	<ul style="list-style-type: none"> ● Enable <ol style="list-style-type: none"> a. You can use “Control address” to control the operation of media player b. Register a device address for “Control address”.
		<ul style="list-style-type: none"> ● Disable <p>There is no manual control of video play operation. The system will start to play the first</p>

		video at designated folder when the window is popup.
	Command	Users set this address to control the operation of media player. ➤ Command (control address + 0)
	Parameter 1	Parameter 1 for control operation. ➤ Parameter 1 (control address + 1)
	Parameter 2	Parameter 2 for control operation ➤ Parameter 2 (control address + 2)
	Status	The system will turn bits ON when state changes or malfunctions. ➤ Status (control address + 3)
	File index	The system will write file index when starting to play a video. ➤ File index (control address + 4)
	Start time	The system will write video start time when starting to play a video. (unit = sec) (Always 0) ➤ Start time (control address + 5)
	End time	The system will write video end time when starting to play a video. (unit = sec) ➤ End time (control address + 6)
	Video playing time	Update video playing time ● Enable The system will write video elapsed time into [playing time] register in every [update period] seconds.
		Update period Update period of [playing time], range between 1 to 60 sec.
		Playing time Update the video elapsed time periodically. (unit = sec) ➤ Playing time (control address + 7)
Video file store location	SD	Play video files in SD card.
	USB1	Play video files in USB1.
	USB2	Play video files in USB2.
	Folder name	The name of the folder storing video files. Users must put video files in a folder (e.g. <i>"/example"</i>) instead of root directory.

		Note 1. [Folder name] couldn't be empty. 2. [Folder name] couldn't include \/:*?"<> .
Attribute	Auto. repeat	When finish playing a video file, the system will automatically play next video. e.g. [video 1] ⇒ [video 2] ⇒ ... ⇒ [video n] ⇒ [video 1]
	Background	Select the background color of the object.

★ Normally the format of the above registers is 16-unsigned integer. If a 32-bit word device is chosen as the control address, only 0-15 bits are effective. Users should zero the 16-31 bits.

Control command :

a. Play index file

[Command] = 1

[Parameter 1] = file index

[Parameter 2] = ignore (set 0)

-
- Note**
1. The files are sorted with file name in ascending order, the "file index=0" is for to the first file, and son on.
 2. If it is unable to scan file, it will set [status] bit 8 to ON.
 3. If check [Auto. repeat], it will automatically play the next file after

finish.

b. Play previous file

[Command] = 2

[Parameter 1] = ignore (set 0)

[Parameter 2] = ignore (set 0)

Note

1. If the [file index] is previously 0, it will re-play the same video from the start.

2. If it is unable to search the right file, it will set [status] bit 8 to ON.

3. If check [Auto. repeat], it will automatically play the next file after

finish.

c. Play next file

[Command] = 3

[Parameter 1] = ignore (set 0)

[parameter 2] = ignore (set 0)

-
- Note**
1. If there is no next video file, it will play the first (index 0) file.
 2. If it is unable to search the right file, it will set [status] bit 8 to ON.
 3. If check [Auto. repeat], it will automatically play the next file after

finish.

d. Pause / Play Switch

[Command] = 4

[Parameter 1] = ignore (set 0)

[Parameter 2] = ignore (set 0)

e. Stop playing and close file

[Command] = 5

[Parameter 1] = ignore (set 0)

[Parameter 2] = ignore (set 0)

f. Start playing at designated target location

[Command] = 6

[Parameter 1] = target location (sec)

[Parameter 2] = ignore (set 0)

-
- Note** Parameter 1 (target location) should less than end time. If it is over end time, the system play video from last second.
-

g. Forward

[Command] = 7

[Parameter 1] = target location (sec)

[Parameter 2] = ignore (set 0)

-
- Note**
1. Increase playing time by [Parameter 1] seconds. If the system is previously playing video, it continues to play after the operation.
-

If previously paused, it keeps paused.

2. If the playing time is over end time, the system play video from last second.

h. Backward

[Command] = 8

[Parameter 1] = target location (sec)

[Parameter 2] = ignore (set 0)

- Note**
1. Decrease playing time by [Parameter 1] seconds. If the system is previously playing video, it continues to play after the operation. If previously paused, it keeps paused.
 2. If the playing time is less than start time, the system play video from the beginning.
-

i. Adjust volume

[Command] = 9

[Parameter 1] = volume (0 ~ 128)

[Parameter 2] = ignore (set 0)

- Note** Default volume is 128.
-

j. Set video display size

[Command] = 10

[Parameter 1] = display size (0 ~ 16)

[Parameter 2] = ignore (set 0)

- Note**
1. [0] : Fit video image to object size.
 2. [1 ~ 16] : Magnification from 25% ~ 400%. Set 1 for 25%, 2 for 50%, 3 for 75% and so on.
-

k. Status (control address + 3)

15	09 08	02 01 00	bit
Reserved (all 0)	0 0		0 0

Bit 00: open file bit (0: file closed ; 1: file opened)

Bit 01: play file bit (0: not playing video ; 1: playing video)

Bit 08: command error bit (0: command accepted ;

When playing a video, the system will turn ON [open file bit] and [play file bit]. If the file is unable to be scanned or the command is incorrect, the [command error bit] will be set ON (0→1).

Note

1. If file format is unsupported or disk I/O error happens during playing (e.g. user unplugs the USB disk), the [file error bit] will be set ON (0→1).
2. Refer to the following figure, the value of [status] at each state would be:

“Stop” [status] = 0

“Pause” [status] = 1 ([open file bit])

“Playing” [status] = 3 ([open file bit] + [play file bit])

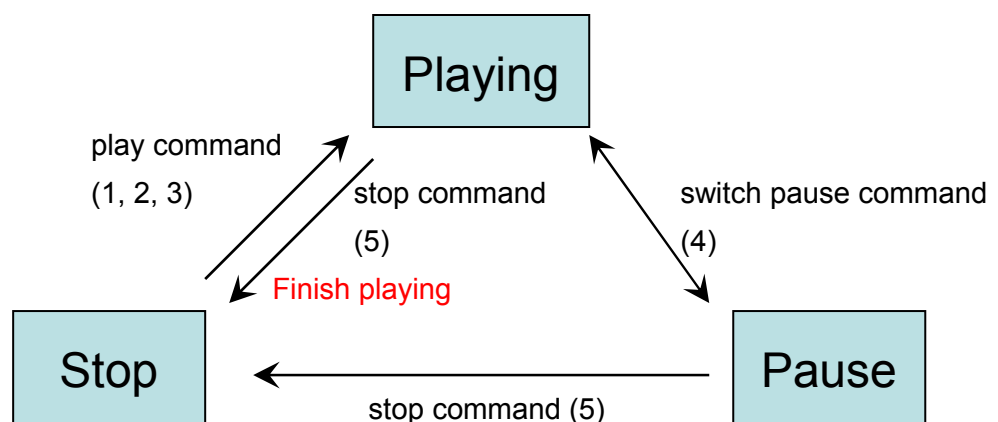

★ Users should only set values to [Command], [Parameter 1] and [Parameter 2],

and regard the other registers as read-only.

Restrictions

- The system can only play one video file each time.
- If [Auto. repeat] is unselected, the system will stop playing video and close the file after complete a video play operation.
- If [control address] is unselected, the system will find the first file in the designated directory and start playing it.

13.26 Data Transfer (Time-based)

Overview

Data transfer (Time-based) object is the same as Data transfer (Trigger-based) object, it also transfers the data from source to destination register. The difference is the way to activate data transfer operation. The Data transfer (time-based) object conducts data transfer operation based on time schedule, it can also transfer data in the unit of bits.

Configuration

Click “Data Transfer (Time-based) Object” icon on the toolbar, the summary of data transfer objects is shown as follows:

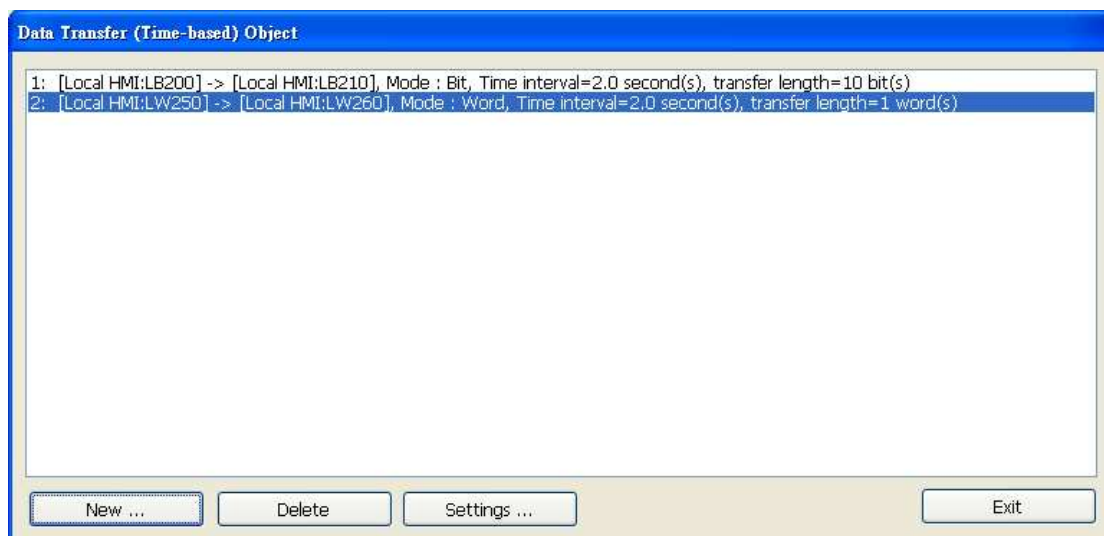

Press the “New...” button in the above dialogue box, the Data Transfer (Time-based) Object dialogue box appear as shown in the picture below, set item and press OK button, the object will be created.

Data Transfer (Time-based) Object

Description :

Attribute

Address type : Bit Interval : 3.0 second(s)

No. of bit :

Active only when designated window opened

Source address

PLC name : Local HMI

Address : LB

Destination address

PLC name : Local HMI

Address : LB

Setting	Description
Attribute	[Address type] Select the bit or word device.
	[No. of words] or [No. of bits] When select "Word type", the unit of data transfer is word, set the number of data to transfer. See the picture below.
	When select "Bit type", the unit of data transfer is bit, set the number of data to transfer. See the picture below.

	<p>[Interval] Select the wait interval for each data transfer, for example, select 3 seconds, the system will conduct data transfer operation every 3 seconds.</p> <p>Note</p> <ol style="list-style-type: none"> 1. Specifying a small interval or a big number of data to transfer may cause an overall performance decrease due to the time consuming in transferring data. Therefore, users should always try to choose a longer interval and a smaller amount of data to transfer. 2. When a short interval is inevitable, be aware of the interval must be longer than the data transfer operation. For example, if the data transfer operation take 2 seconds, you must set the interval longer than 2 seconds.
<p>Source address</p>	<p>Set source address. Click [Setting...] to Select the [PLC name], [Device type], [Address], [System tag], [Index register] of source address. Users can also set address in General tab while adding a new object.</p>
<p>Destination address</p>	<p>Set destination address. Click [Setting...] to Select the [PLC name], [Device type], [Address], [System tag], [Index register] of destination address. Users can also set address in General tab while adding a new object.</p>

After completing all settings and pressing the “OK” button, a new Data Transfer (Time-based) Object is created. The summary displays all the registered data transfer objects with brief information as shown below.

Data Transfer (Time-based) Object

- 1: [Local HMI:LB200] -> [Local HMI:LB210], Mode : Bit, Time interval=2.0 second(s), transfer length=10 bit(s)
- 2: [Local HMI:LW250] -> [Local HMI:LW260], Mode : Word, Time interval=2.0 second(s), transfer length=1
- 3: [Local HMI:LB30] -> [Local HMI:LB60], Mode : Bit, Time interval=3.0 second(s), transfer length=15 bit(s)

13.27 PLC Control

Overview

The PLC control object activates a specific operation when the corresponding control device is triggered.

Configuration

Click the “PLC Control” icon and the “PLC Control Object” summary appears as shown below.

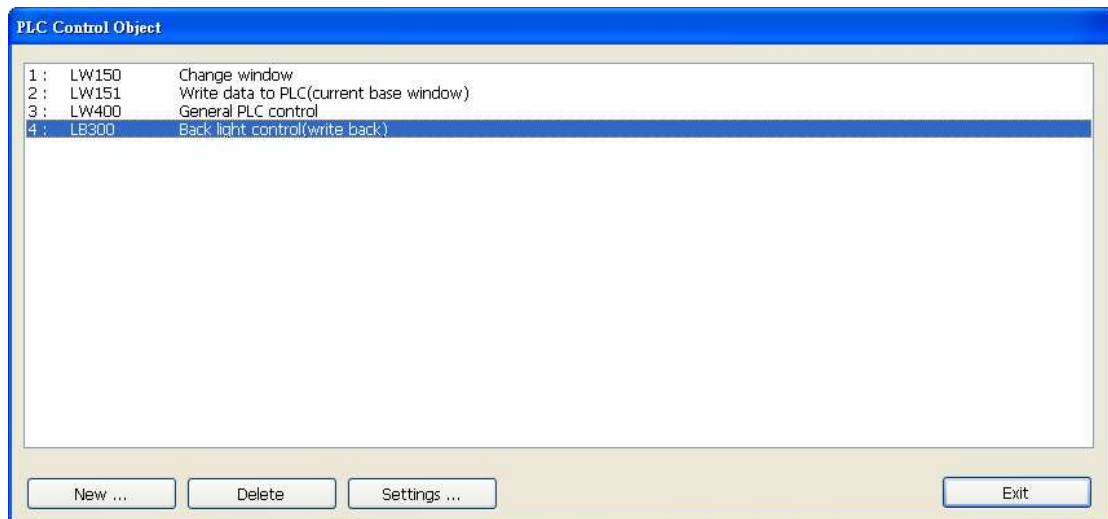

Press the “New...” button and the “PLC Control” dialogue box appears. Set all the attributes of PLC control and press OK button, a new PLC control object will be created.

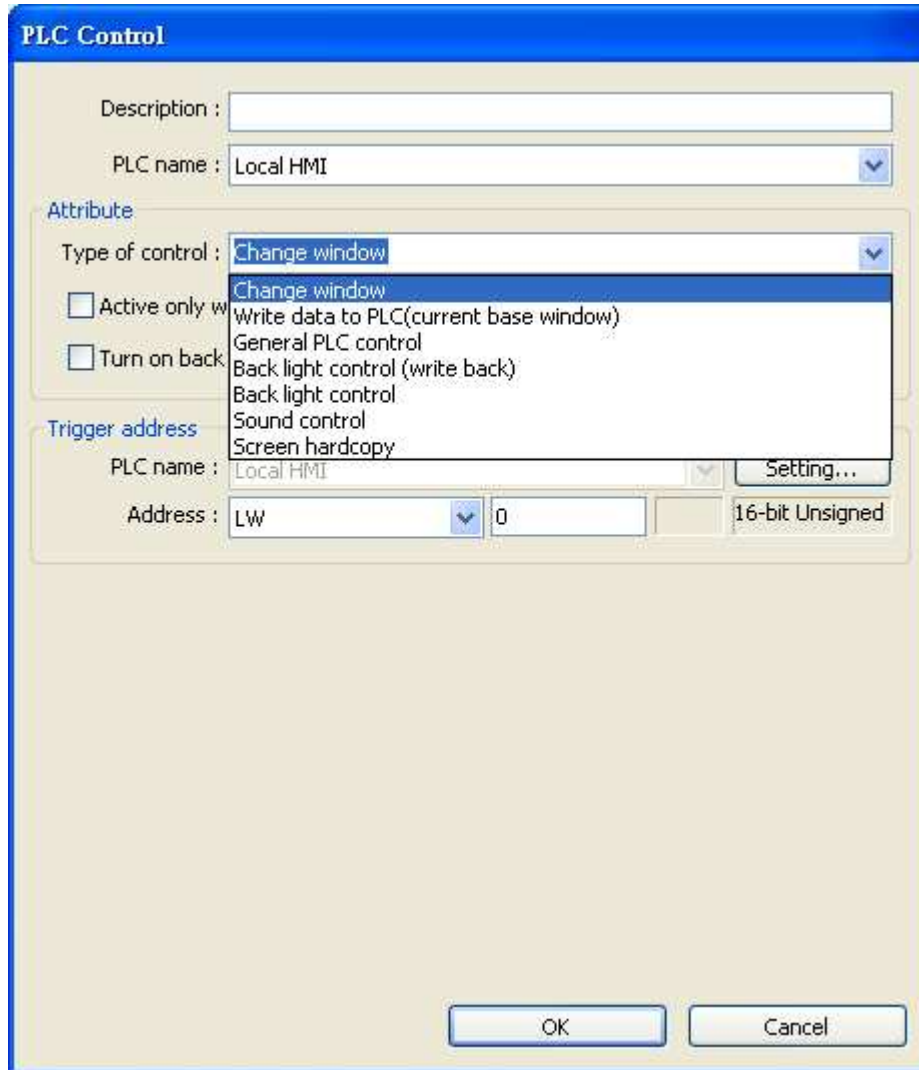

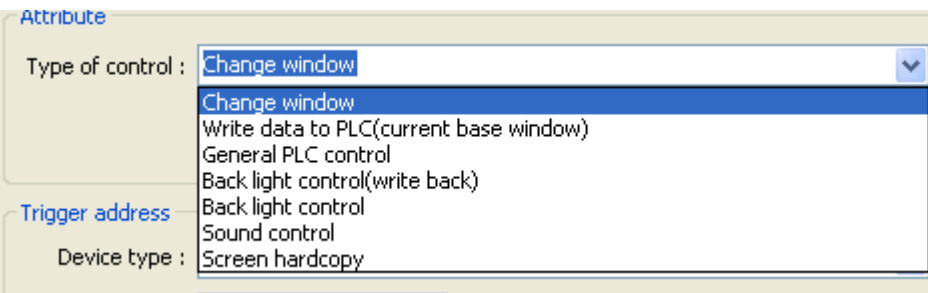
Setting	Description
Attribute & Trigger address	<p>[Type of control]</p> <p>To set the type of control. Click the select button and you can drag down a list of all available PLC control functions</p> 
	<p>a. "Change window"</p> <p>This is used to change base window. When the value of [Trigger address] is written in a valid window number, the system will close the current window and open the window designated by the</p>

[Trigger address]. The new window number will be written to the [Trigger address + 1].

As an example of the above configuration. When writing a valid window number – 11 into LW0, the system will close the current window and open window 11, then write 11 into LW1 (LW0+1)

If you use 32-bit device as trigger address, and the device type of the trigger address is in word basis, then the system will write the window number into [Trigger address +2].

Below is the list of write address for each different type of data format.

Data Format	Trigger address	Write address
16-bit BCD	Address	Address + 1
32-bit BCD	Address	Address + 2
16-bit Unsigned	Address	Address + 1
16-bit Signed	Address	Address + 1
32-bit Unsigned	Address	Address + 2
32-bit Signed	Address	Address + 2

Note: If [LB-9017] = ON, the write back operation will not be executed.

If “Clear data after window changed” is selected, the [Trigger

address] will be reset to 0 after new window is open.

b. “Write data to PLC (current base window)”

When the system changes the base window, the new window number will be written into the [Trigger address].

c. “General PLC Control”

This function performs data transfer between PLC and HMI when users set appropriate value in [Trigger address].

Control code [Trigger address]	Operation for data transfer
1	PLC register → HMI RW
2	PLC register → HMI LW
3	HMI RW → PLC register
4	HMI LW → PLC register

With this function the system uses four continuous word devices, please refer to the following explanation.

Address	Purpose	Description
[Trigger address]	Control code	The valid control code is listed in the above table. When a control code is written into register, the system will conduct the data transfer function.
[Trigger address+1]	Number of words to transfer	
[Trigger address+2]	Offset to the start address of PLC register	If the value is “n”, the start address of PLC register is “Trigger address + 4 + n”.
[Trigger address+3]	The start address of LW or RW	

As an example, to transfer PLC registers [DM100, 101 ... 105] to HMI [RW10, 11 ... 15], follow the steps below:

1. Set Trigger address to DM10.
2. Set [DM11] = 6 (no. of words to transfer)
3. Set [DM12] = 86 (DM10+4+86= DM100)

4. Set [DM13] = 10 (RW10)

5. Set [DM10] = 1, The system will execute the data transfer operation.

d. “Back light control (write back)”

Set [Trigger address] to “ON”, the system will turn on/off the backlight and reset the [Trigger address]. Any touch on the screen will turn the backlight on.

e. “Back light control”

This operation is the same as “Back light control (write back)” except the system would not reset the [Trigger address].

e. “Sound control”

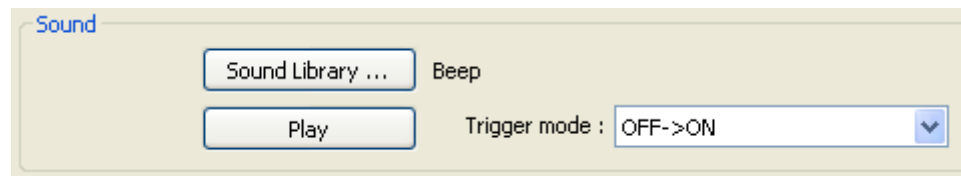

Activate the [Trigger address], the system will play the sound.

Select a sound from sound library for the PLC Control.

You may configure three different ways to activate the [Trigger address]:

(1) State change from OFF to ON (OFF->ON)

(2) State change from ON to OFF (ON->OFF)

(3) State change (either from ON->OFF or OFF->ON)

f. “Execute macro program”

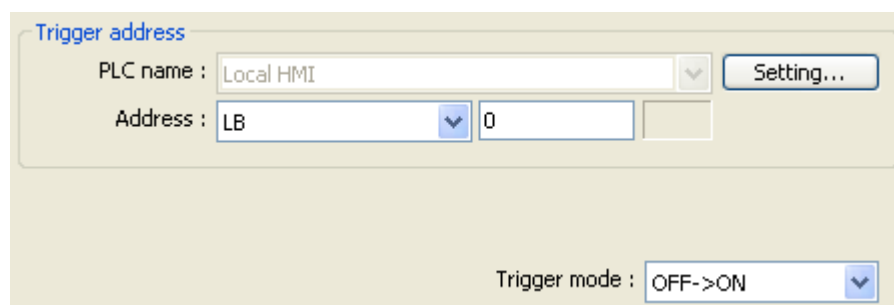

Activate the [Trigger address], the system will execute the Macro.

You may configure three different ways to activate the [Trigger address]:

- (1) State change from OFF to ON (OFF->ON)
- (2) State change from ON to OFF (ON->OFF)
- (3) State change (either from ON->OFF or OFF->ON)
- (4) Always active when ON

h. “Screen hardcopy”

Activate the [Trigger address], the system will have designated window printed out.

You may configure three different ways to activate the [Trigger address]:

- (1) State change from OFF to ON (OFF->ON)
- (2) State change from ON to OFF (ON->OFF)
- (3) State change (either from ON->OFF or OFF->ON)

The designated window can be one of following three different types:

Source window for print

Current base window
 Window no. from register
 Designate window no.

PLC name : Local HMI Setting...

Address : LW 0 16-bit Unsigned

Printer : USB disk 1

[Current base window]

Print the current base window when the operation is activated.

[Window no. from register]

Print the window designated by a PLC device when the operation is activated, if [LW0] = 14, the window no.14 will be printed out.

[Designate window no.]

Select a base window to be printed out when the operation is activated.

Note

1. The system performs a ***background printing process*** when the printed window is not the current base window.
2. For a window designed to be printed at background, users should put neither direct window nor indirect window in it.

13.28 Schedule

Overview

Schedule object is used to turn on/off a bit or write a value to a word device at designated time. The time schedule setting is very flexible, it can be on daily basis or weekly basis. For more advance application you can use a table (a block of word devices) to set start and terminate time, then update the table at any scheduled time.

Configuration

Click the “Schedule” icon on the toolbar and the “Scheduler list” dialogue box will appear, press the “New”, the schedule object dialogue box will appear as shown below:

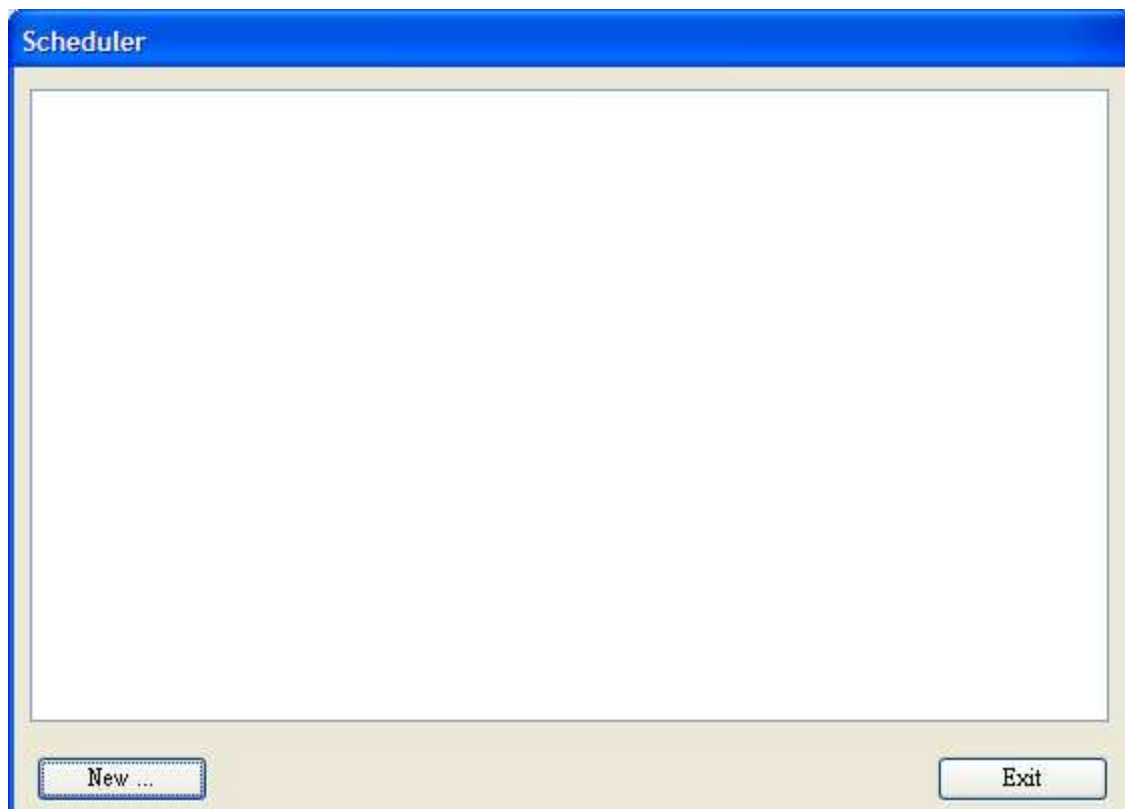
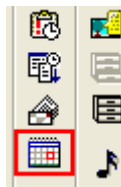

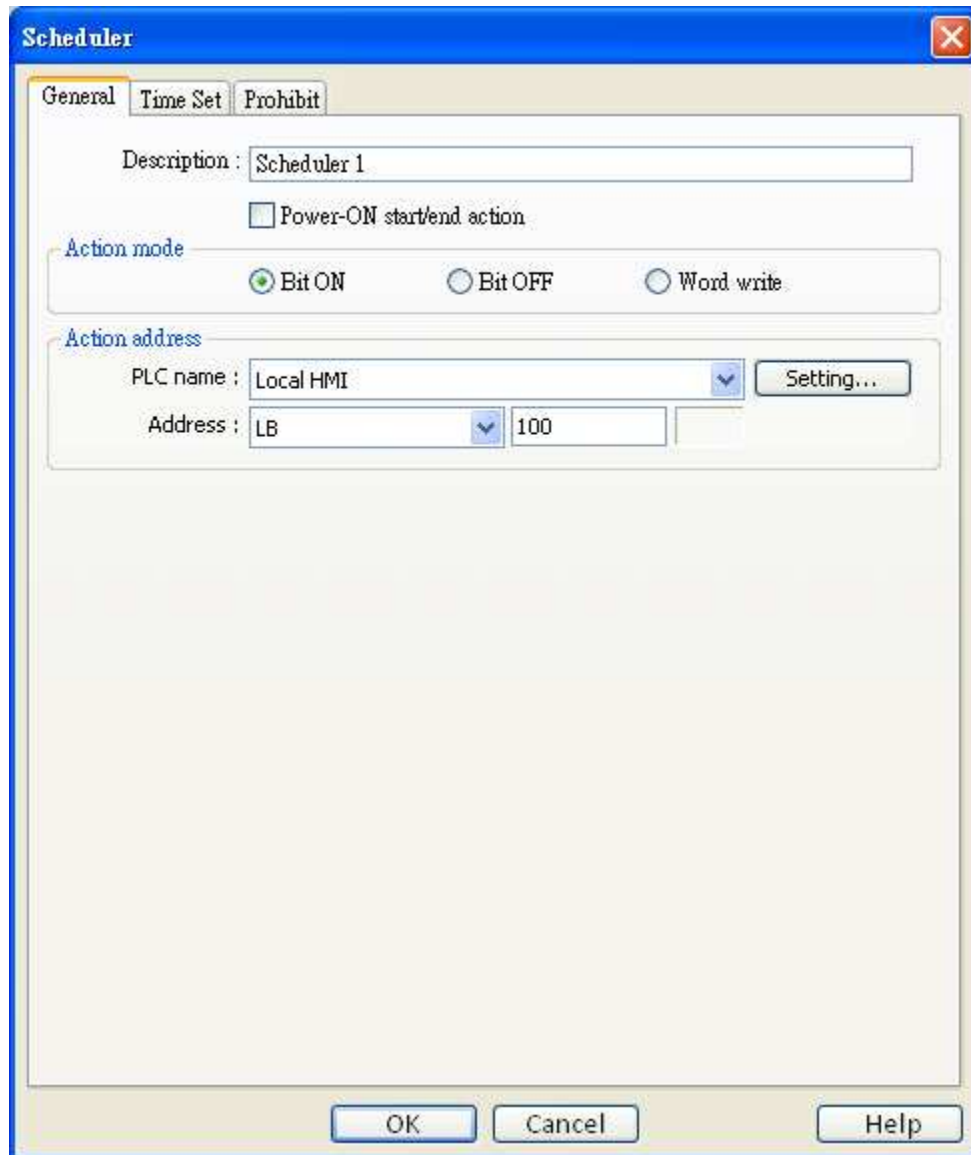
**Example 1:**

The motor is scheduled to be power ON at 8:00 and power off at 17:00, Monday to Friday.

Here we use LB100 to control the motor. Follow the steps to set up the schedule object.

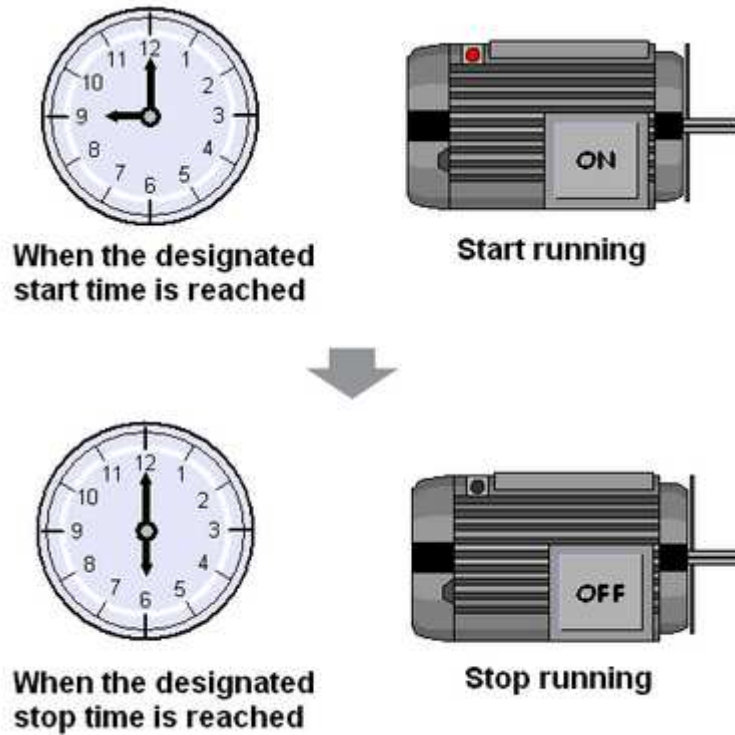

Click [New...], to add a new object,

[General tab]

[Power-ON start/end action]

Detail message please refer to below Scheduler settings guide.

Power-ON start/end action

1. Check [Bit ON] in [Action mode],

Action mode

Bit ON Bit OFF Word write

2. Set LB100 in [Action address]

Action address

PLC name : Local HMI

Address : LB

[Time Set tab]

3. Select [Time Set] tab, check [Constant]

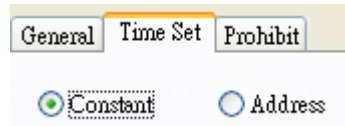

4. Unselect [Setting on individual day]. In [Start], adjust time as 8:00:00 and select Monday to Friday.

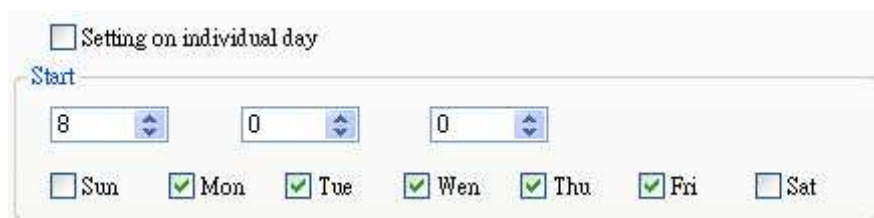

5. In [End], select [Enable termination action] and adjust time as 17:00:00.

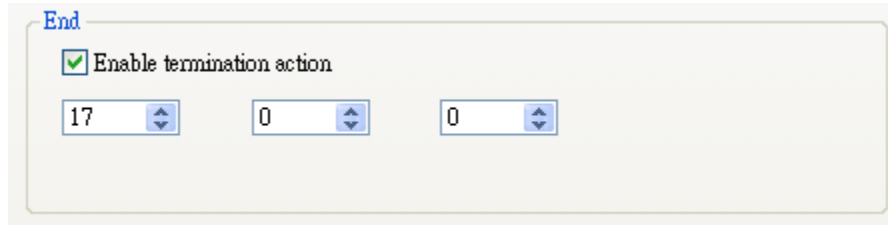

6. Click [OK], a new schedule object is created and display on the schedule list.

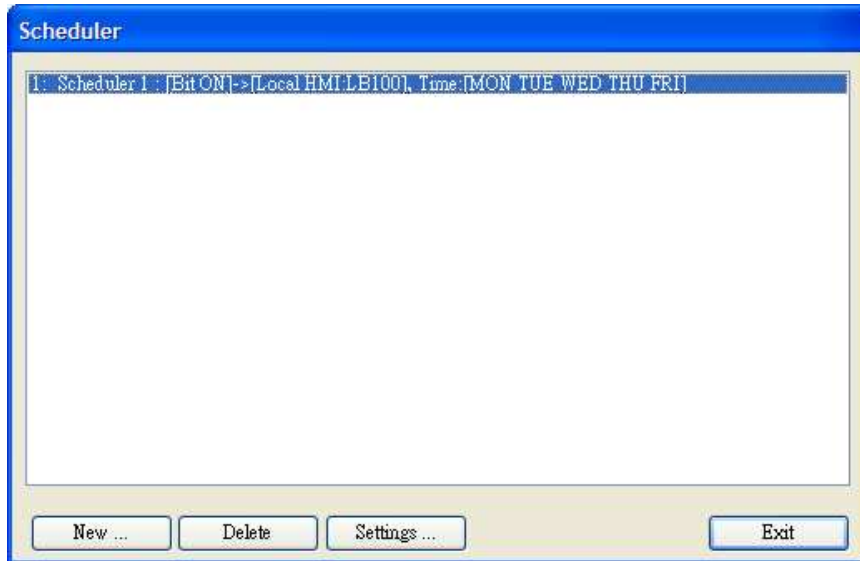

Example 2:

Set temperature at 90F at 8:00 and set it back to 30F (standby mode) at 17:00, Monday to Friday.

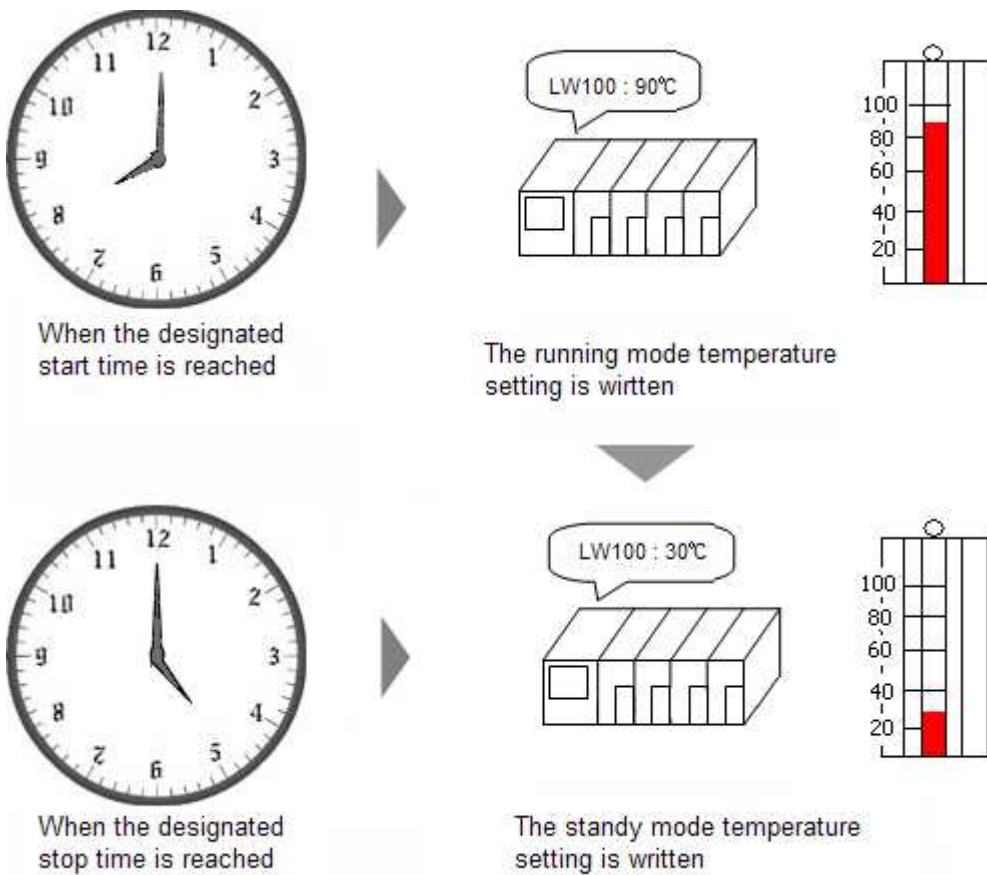

Click [New...], to add a new schedule object. Follow the steps to set up the schedule object. The [LW100] is used to store set value of temperature.

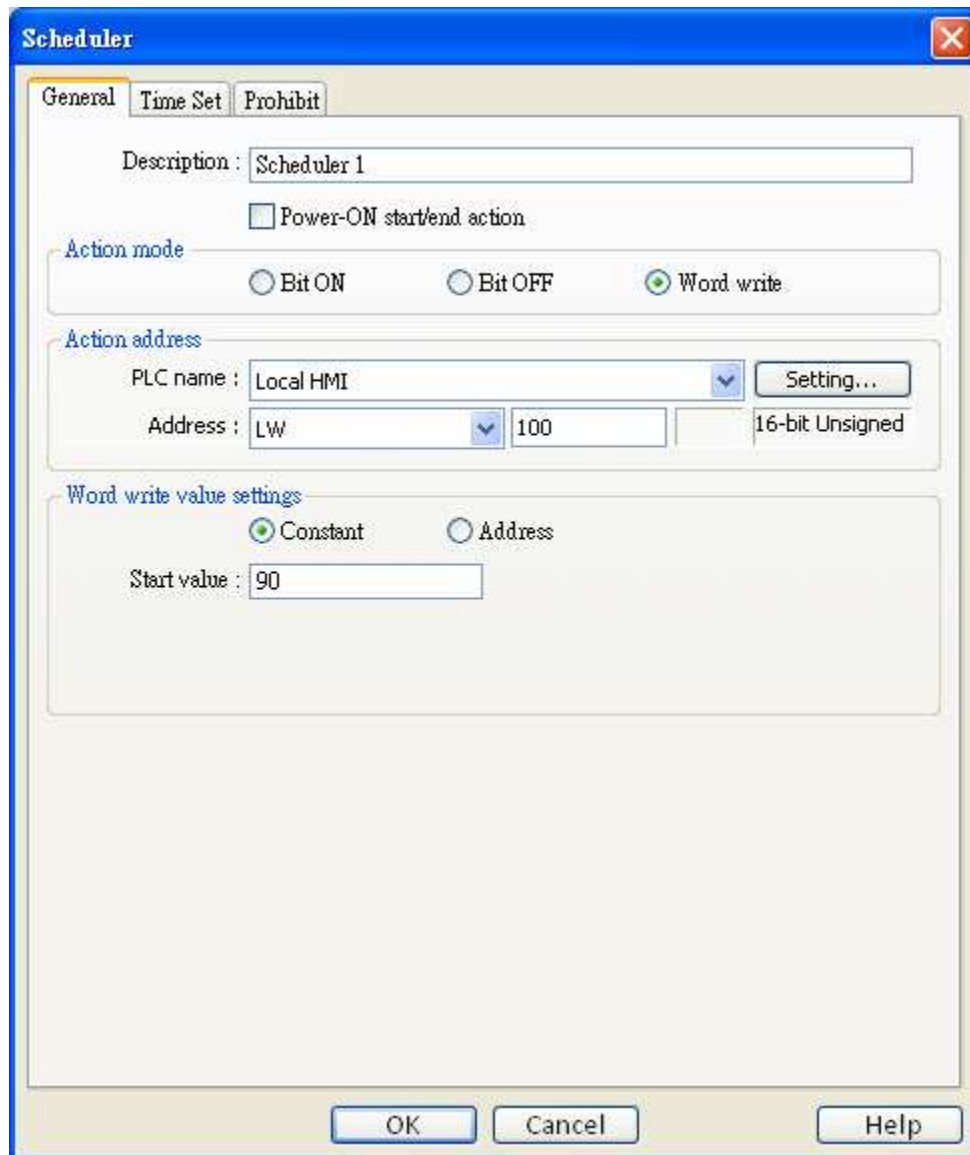

[General tab]

1. [Power-ON start/end action]

Power-ON start/end action

2. Check [Word write] in [Action mode],

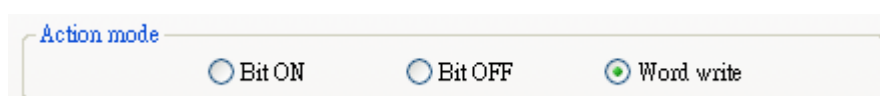

3. Set LW100 in [Action address]

Action address

PLC name : Local HMI Setting...

Address : LW 100 16-bit Unsigned

4. Check [Constant] and set [Write start value] to 90 in [Word write value settings],

Word write value settings

Constant Address

Write start value : 90

[Time Set tab]

5. Select [Time Set] tab, check [Constant]

General Time Set Prohibit

Constant Address

6. Unselect [Setting on individual day]. In [Start], adjust time as 8:00:00 and select Monday to Friday.

Setting on individual day

Start

8 0 0

Sun Mon Tue Wen Thu Fri Sat

7. In [End], select [Enable termination action] and adjust time as 17:00:00.

End

Enable termination action

17 0 0

8. Select [General] tab, set [Write start value] to 90 and [Write end value] to 30.

Write start value : 90

Write end value : 30

9. Click [OK], the settings appear in the Scheduler list.

Schedule settings guide

■ General tab

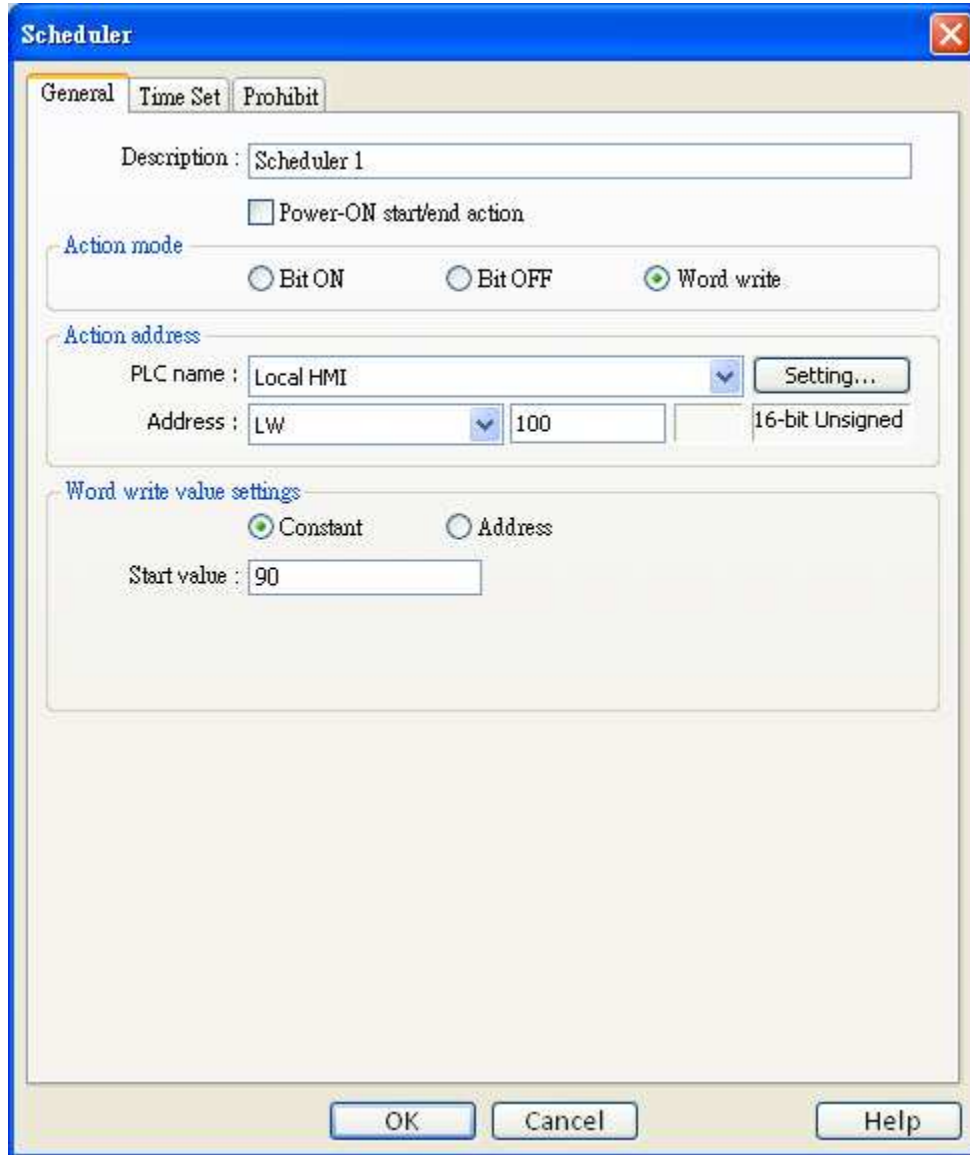

Setting	Description
Action Mode	Select the type of operation performed at designated time.

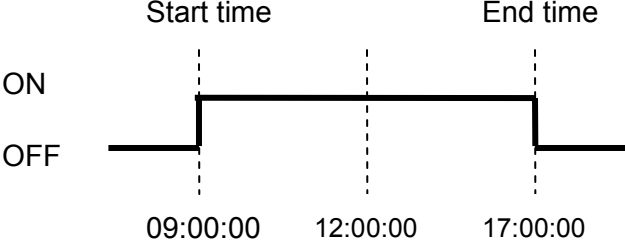
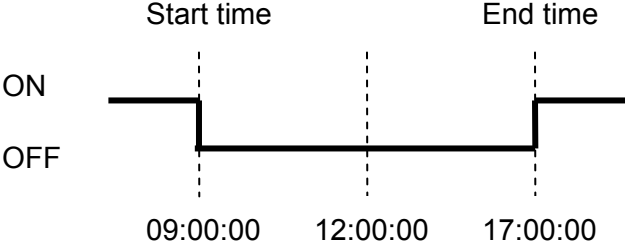
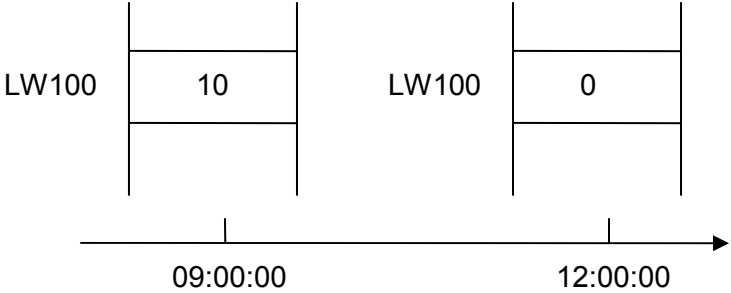
<p>[Bit ON]</p>	<p>At start time, turn ON the specific bit. At end time, turn OFF the bit. Example: Start time = 09:00:00 End time = 17:00:00</p> 
<p>[Bit OFF]</p>	<p>At start time, turn OFF the specific bit. At end time, turn ON the bit. Example: Start time = 09:00:00 End time = 17:00:00</p> 
<p>[Word write]</p>	<p>At start time, the specific [Write start value] is written to the action address. At end time, [Write end value] is written to the action address. Example: Device address = LW100 Start time = 09:00:00 End time = 12:00:00 Write start value = 10 Write end value = 0</p> 
<p>Action address</p>	<p>Specify the address where the scheduler performs actions on.</p>

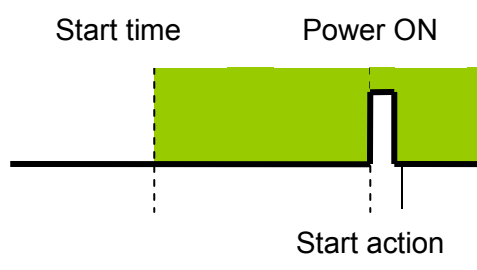
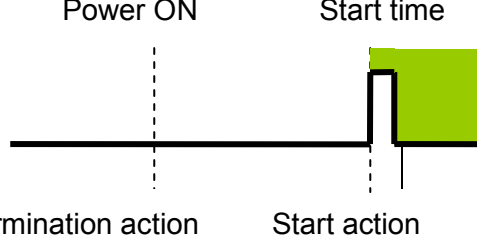
Setting	Description
Power-ON start/end action	<p>Select the action to perform when power is turned on.</p> <ul style="list-style-type: none"> Enable If the MT8000 power is turned ON within the scheduler range, the start action is performed. If the MT8000 power is turned ON outside of the scheduled range, the termination action is performed. <div style="text-align: right;"> <p>Inside the scheduled range:</p>  <p>Outside the scheduled range:</p>  </div> Disable If power is turned ON but the time is later than the Start Time, the action is not automatically performed. However, the termination action is automatically performed. <p style="text-align: right;">Also, if the termination action is not set, the schedule range is unable to recognize and the action is not performed.</p>
Word write value Settings	These settings are active only when Action Mode is set to [Word Write].

	<p>When performing start action, the system will write this value into action address.</p> <p>[Write start value]</p> <ul style="list-style-type: none">• For [Constant] Designates the value to be written at start time.• For [Address] Designates the address used to store the start time value. <p>[Write end value]</p> <p>When performing end action, the system will write this value into action address.</p> <ul style="list-style-type: none">• For [Constant] Designates the value to be written at end time.• For [Address] Designates the address used to store the end time value. <p>Note</p> <ul style="list-style-type: none">• You can use this option if the [Enable termination action] in [Time Set] tab is selected.
--	--

■ Time Set tab (when [Constant] is selected)

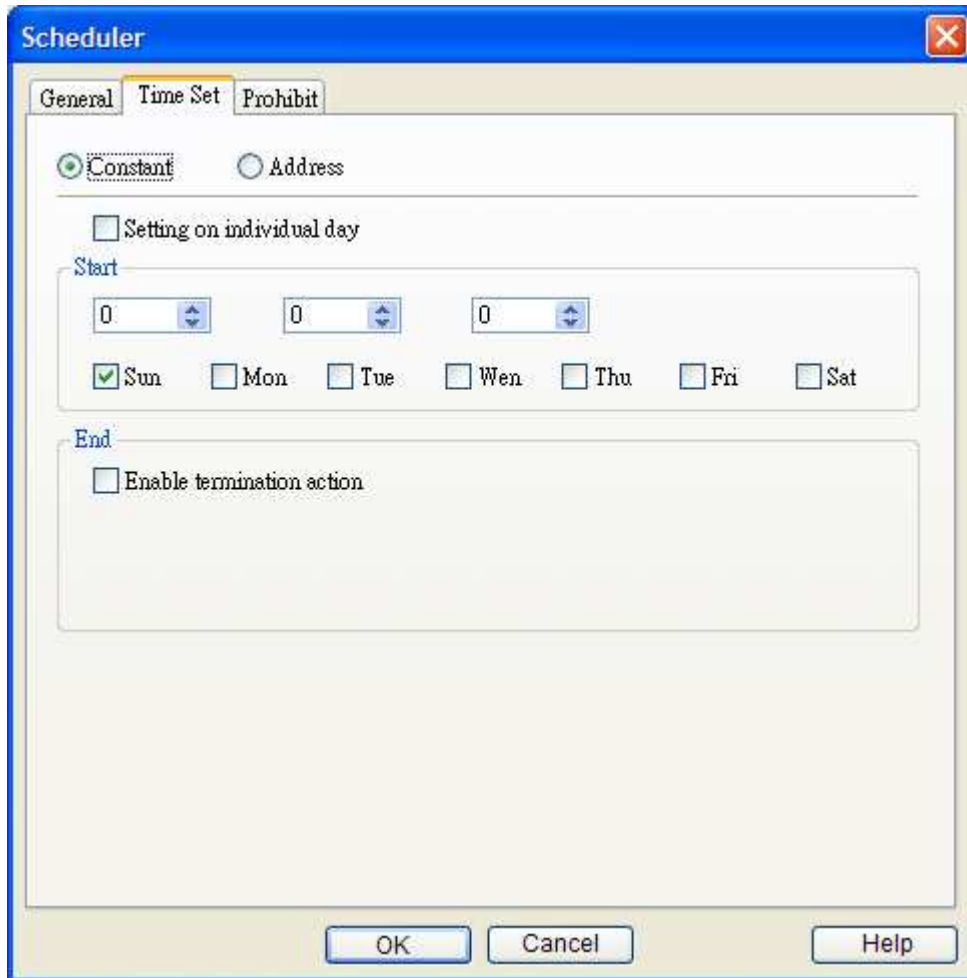

Setting	Description
Constant/Address	<p>Select the method to set the start time and end time.</p> <ul style="list-style-type: none"> • Constant Specifies a fixed time and day. • Address The start/end time is retrieved from the device address at on line operation.
Setting on individual day	<ul style="list-style-type: none"> • Enable Start time and end time can be set in different day of week. There is only one start time and one end time during the week. You have to set both start time and end time with this mode.

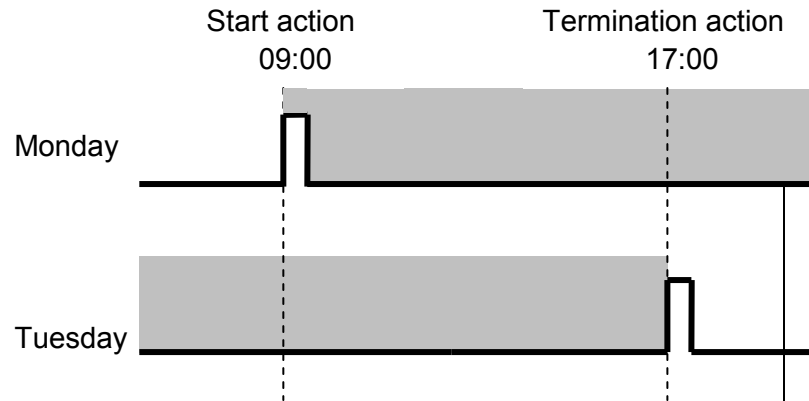
**NOTE**

1. You must enter settings for the Start Time and End Time.

2. You cannot set the Start Time and End Time to the exact same day and time.

- Disable

A schedule that is 1 day (Start and End times are within 24 hours) can be entered. Multiple Start and End days can be selected. You can perform actions at the same time on multiple days.

To specify an End Time, you must select [Enable termination action]

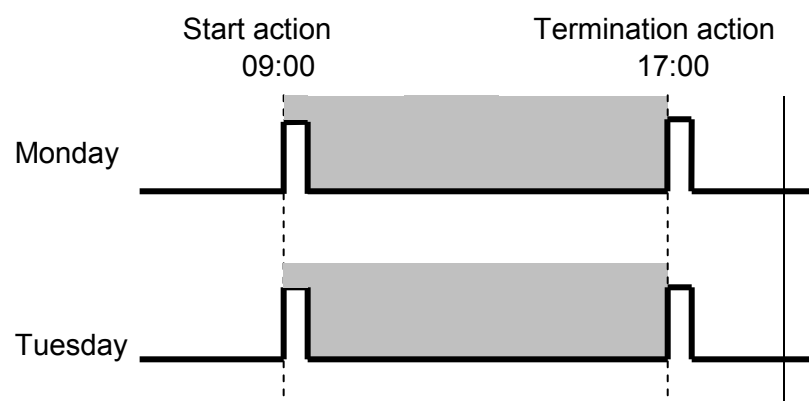
**NOTE**

- You cannot set the Start Time and End Time to the exact same day and time.
- The time scheduler is for one day only, so if the End

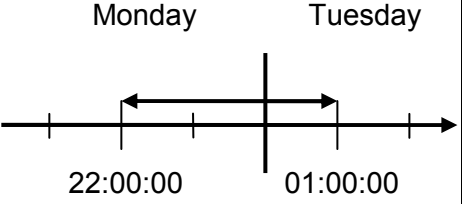
	<p>Time is earlier than the Start Time, the operation of End Time will be performed on the next day.</p> <p>(For example)</p> <p>Start day: Monday</p> <p>Start: 22:00:00</p> <p>End: 01:00:00</p> 
<p>Start</p>	<p>Set the start time and day.</p> <p>When [Setting on individual day] is disabled, user can designate more than one day.</p>
<p>End</p>	<p>Set the end time and day.</p> <p>When [Enable termination action] is selected, the end time can be specified.</p> <p>The day settings can only be set when [Setting on individual day] is enabled.</p>

■ Time Set tab (when [Address] is selected)

If “address” mode is selected, the system retrieves the start/end time and day from word devices. Therefore, users can set and change scheduled time in operation.

The screenshot shows the 'Scheduler' dialog box with the 'Time Set' tab selected. The 'Address' radio button is chosen. The 'Time setting address' section includes a 'PLC name' dropdown set to 'Local HMI' and an 'Address' dropdown set to 'LW' with a value of '0'. Below this are 11 input fields for time settings, each with a label and a value:

Control :	0
Status :	0 + 1
Action mode :	0 + 2
Start time (day) :	0 + 3
Start time (hour) :	0 + 4
Start time (minute) :	0 + 5
Start time (second) :	0 + 6
End time (day) :	0 + 7
End time (hour) :	0 + 8
End time (minute) :	0 + 9
End time (second) :	0 + 10

Buttons for 'OK', 'Cancel', and 'Help' are located at the bottom of the dialog.

User designates the [Time setting address] as the top address used to store time settings data. The 11 word devices are automatically allotted.

Normally the format of the above word devices is 16-unsigned integer. If a 32-bit word device is chosen, only 0-15 bits are effective and users should zero the 16-31 bits.

a. Control (Time setting address + 0)

The layout of the Control word is shown below. Users set the [time acquisition request bit] ON (0→1) to make the system reads the [Action mode], [Start time], and [End time] and uses them as the new scheduled time.

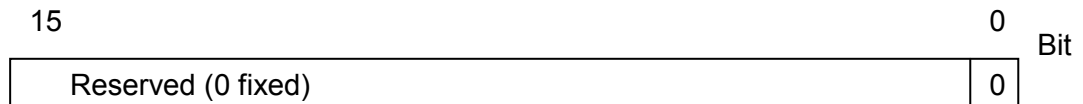

Bit 00: time acquisition request bit (0: no action, 1: perform time read)

NOTE The system would not read start and end time data unless the [time acquisition request bit] is set ON.

b. Status (Time setting address + 1)

The layout of the Status word is shown below.

When the system completes the read operation, it will turn the [time acquisition complete bit] ON (0→1). Also, if the read time data is incorrect, the [error notification bit] will be turned ON (0→1).

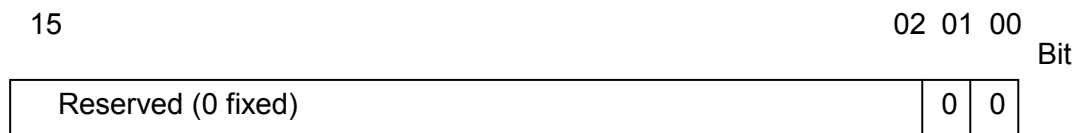

Bit 00: time acquisition complete bit (0: null, 1: read operation complete)

Bit 01: error notification bit (0: no error, 1: start or end time format is incorrect)

NOTE After system reads the time data and turns the [time acquisition complete bit] ON, be sure to turn [Control] [time acquisition request bit] OFF. Once this bit is turned OFF, the system will set both the

[Status] [time acquisition complete bit] and [error notification bit] to OFF.

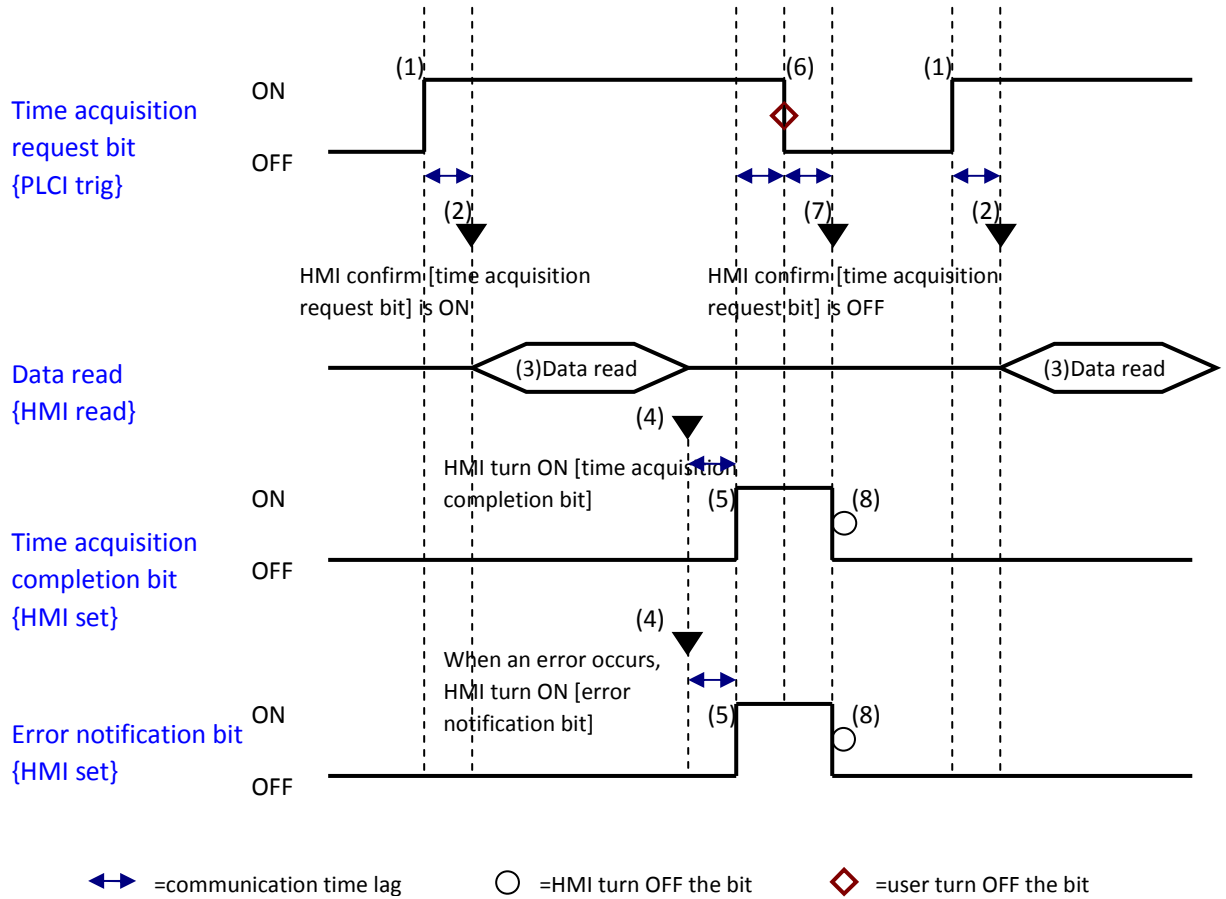

c. Action mode (Time setting address + 2)

Enable and disable the [Termination time action] and [Setting on individual day].

15	02 01 00	Bit
Reserved (0 fixed)	0 0	

Bit 00: Termination time setting (0: disable, 1: enable)

Bit 01: Setting on individual day (0: disable, 1: enable)

NOTE

1. If [setting on individual day] is OFF, the system still reads all 11 word devices but ignores the end time data.
2. If [setting on individual day] is ON, be sure to enter all start and end time information. If 2 or more of the start/end day bits are turned ON simultaneously, an error occurs.

d. Start/End Day (Start Day: Time setting address + 3, End Day: Time setting address + 7)

Designates the day used as a trigger for the start/termination action.

15		07	06	05	04	03	02	01	00	Bit
Reserved (0 fixed)			Sat	Fri	Thu	Wed	Tue	Mon	Sun	

- Bit 00: Sunday (0: none, 1: select)
- Bit 01: Monday (0: none, 1: select)
- Bit 02: Tuesday (0: none, 1: select)
- Bit 03: Wednesday (0: none, 1: select)
- Bit 04: Thursday (0: none, 1: select)
- Bit 05: Friday (0: none, 1: select)
- Bit 06: Saturday (0: none, 1: select)

e. Start/End Time (Start Time: Time setting address + 4 to + 6, End Time: Time setting address + 8 to + 10)

Set the time values used for the start/termination actions in the following ranges.

Hour: 0 - 23

Minute: 0 - 59

Second: 0 - 59

If you specify a value outside the range, an error will occur.

NOTE The time data format shall be **16-bit unsigned**, system doesn't accept BCD format.

■ Prohibit tab

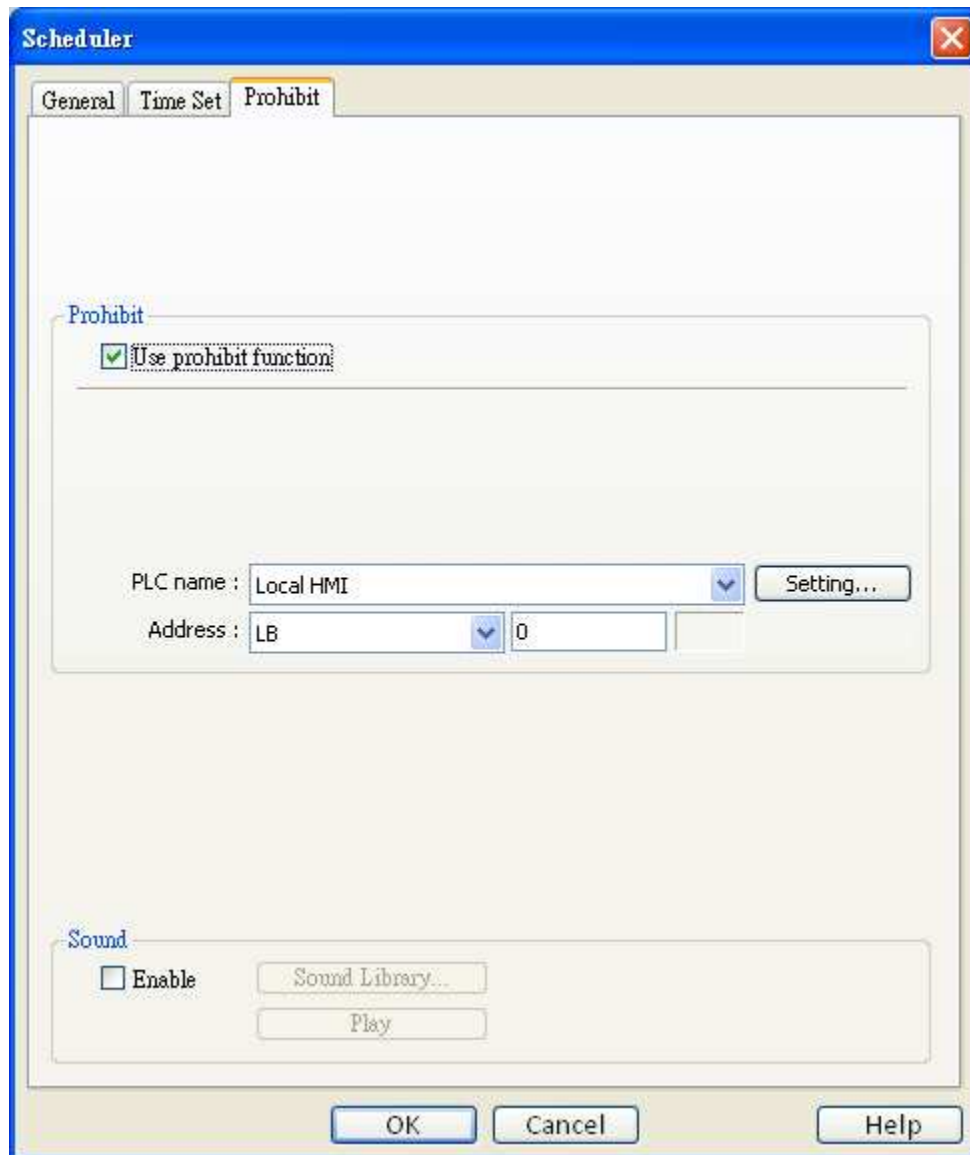

Setting	Description
Prohibit	<ul style="list-style-type: none"> • Enable MT8000 reads the bit status before performing start action. If the bit is ON, the schedule action is not performed.
Sound	<ul style="list-style-type: none"> • Enable When performing start and termination action, the system will simultaneously play the specified sound.

Restrictions:

- User can register the maximum of 32 entries in Scheduler list.
- The time scheduler features are one time actions. When the start time or end time is reached, the system writes the value to device just one time. (not repeated)

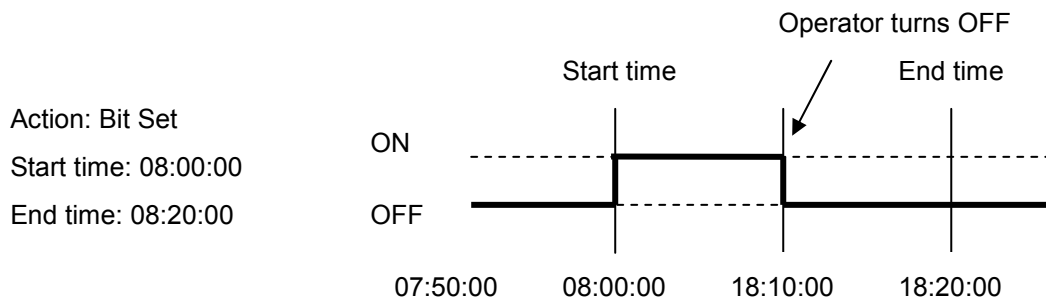

- Once the system execute start action, it will read [Write start address] and [Write end address] altogether, after then, even you change the value of [Write end address], the system would not use the new value.
- When the operator changes RTC data, for those schedule object with both start time and end time setting, the system will check if the time update changes the status from out of schedule range to within schedule range, if it is, the start action will be performed.
- If there are several schedule objects registered the same start time or end time, when time up the system will perform the operation from the first to the last in ascending order.
- When [Time Set] are specified as [Address] mode, the system will read [control] word periodically.
- When [Time Set] are specified as [Address] and start time and end time is over valid range, the system may not execute operation properly.
- When [Time Set] are specified as [Address], the action will not start up until time data update is success.

13.29 Option List

Overview

An Option List displays a list of items that the user can view and select. Once the user selects an item, the value corresponding to the item will be written to a word register. There are two forms for this object – Listbox and Drop-down list. The listbox lists all items and highlights the selected one. However, the drop-down list normally displays only the selected item. Once the user touches it, the system will display a listbox (which is similar to the one with Listbox style) beneath the object.



Configuration

Click the “Option List” icon , “Option List object properties” dialogue box appears as follows:

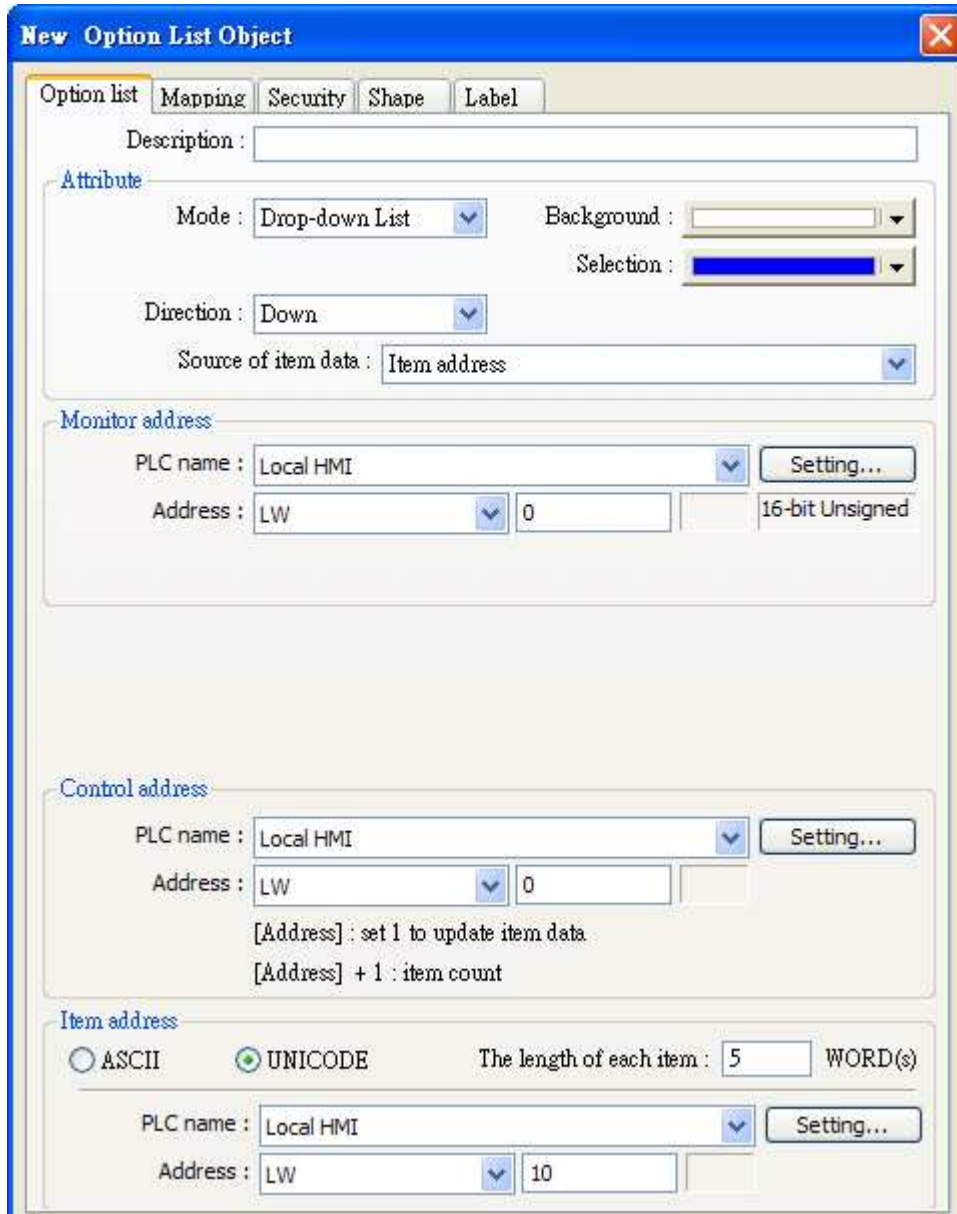

■ Option list tab

Setting	Description
Attribute	<p>[Mode] Select the object style; one of Listbox and Drop-down list.</p> <p>[Item no.] Set the number of items for the object. Each item represents a state displayed in the list and a value to be written to the [Monitor address].</p> <p>[Background]</p>

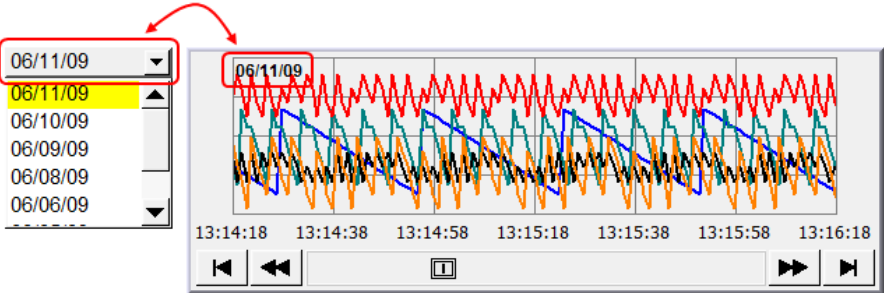
	<p>Select background color for the object.</p> <p>[Selection] Select background color for the selected/highlighted item.</p> <p>[Source of item data]</p> <p>There are Predefine, Dates of historical data, and Item address for selection.</p>
<p>Predefine mode</p>	<p>Monitor address</p> <p>Select the [PLC name], [Device type], [Address] of the word register device that controls the display of the object and the system writes the value of the item to the word register.</p> <p>[Write when button is released] If this function is selected, the operation is activated at touch up. If the function is not selected, the operation is activated at touch down.</p> <p>NOTE: This option is only available in listbox style.</p>
<p>Dates of historical data mode</p>	<p>Item data from dates of historical data (History index mode)</p> <p>Option List object can be used with Historical Event-Display, Trend-Display and Data-Display for displaying the History File on the Historical Display objects as below illustration.</p> <div data-bbox="555 1375 1442 1666" data-label="Figure">  </div> <p>[Type]</p> <p>Alarm (Event) log is used to display Historical Event-Display.</p> <p>Data sampling is used to display Historical Trend-Display or Data-Display.</p>

	<p>[Date]</p> <p>Set the date format.</p> <p>[Data Sampling object]</p> <p>Users have to select which Data sampling object is triggered when selecting “Data sampling” as [Type].</p> <p>Users should select the same data sampling object with the one selected in Historical Trend-Display or Data-Display.</p> <p> Note:</p> <ol style="list-style-type: none"> 1. The system will automatically disable Mapping table when History Index mode is selected. 2. When users select ”Drop-Down List” in [Attribute] and enable History Index mode, the Option List displays “?” in Error State.
<p>Item address mode</p>	<p>When selecting [Item address], users have to correctly set the content of [Control address] and [Item address].</p> <p>Control address</p> <p>[Address]</p> <p>Set “1” to the data of the designated register of this address for updating items displayed in Option List using the content of designated register of [Item address]. After updating, the data in this register will restore to “0”.</p> <p>[Address] + 1</p> <p>The next address of the designated [Control address], data in this address is for setting the number of items.</p>

Item address

This address is for storing the contents of the items.

[ASCII]

Use ASCII as item contents.

[UNICODE]

Use UNICODE as item contents, such as Chinese characters.

The UNICODE to be used must also be used in other objects. EasyBuilder8000 will then compile these font files in advance, and save to HMI when downloading, only in this way the UNICODE can be displayed correctly.

[The length of each item]

As for item length, it's now restricted to less than 1024 when [number of items] times [The length of each item].

Note: The system will automatically disable Mapping table when Item address mode is selected.

■ Mapping tab

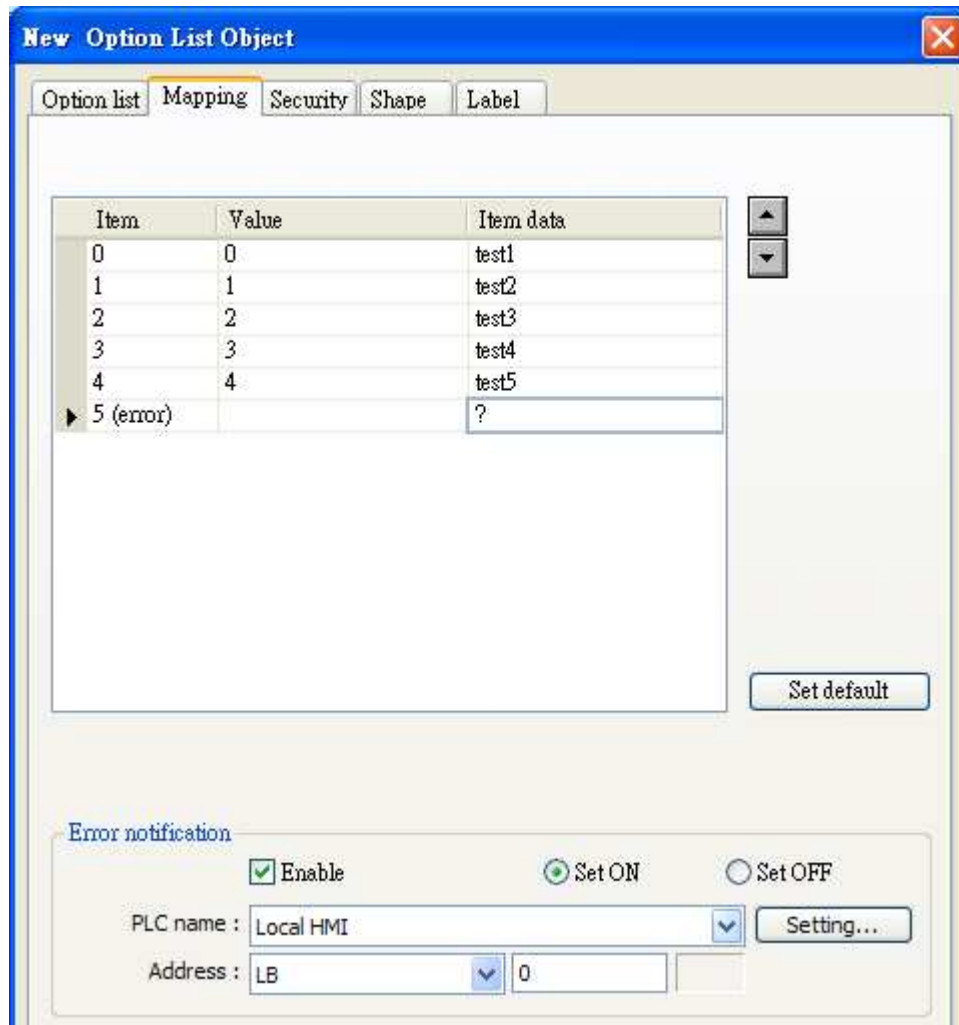

Setting	Description
Mapping table	<p>This table displays all available states/items, their item data and values. To change the number of available items, please refer to [Option list tab] → [Attribute] → [Item no.].</p> <p>[Item]</p> <p>The system lists all available items. Each item represents a state that will be displayed in the list. This field is read-only.</p> <p>[Value]</p> <p>Here user can assign value for each item, basing on the following two criteria:</p> <ol style="list-style-type: none"> [For reading]: If any change of the content from [Monitor

	<p>address] is detected, the object compares the content with these values and selects the first matched item. If no item is matched, the status goes to error state and signals the notification bit register (if requested).</p> <p>b. [For writing]: The system writes this value to [Monitor address] when user selects an item.</p> <p>[Item data]</p> <p>Users can assign data for each item. The option list object displays the data of all items in the list for users to review and select.</p> <p>[Error state]</p> <p>a. For example, item 8 is the error state when specifying 8 in [Item no.]. Similarly, if you set [Item no.] to 11 then state 11 would be the error state, and so on.</p> <p>b. On error state, the listbox-style option list removes the highlight to represent no item is selected and the drop-down list displays the data of error state.</p> <p>c. The item of error state is only applied to the drop-down list style. The listbox-style list has nothing to do with this item.</p>
[Set default]	Set default values for all states, i.e. set 0 for item 0, 1 for item 1, and so on.
Error Notification	The system will set ON/OFF to the specified bit register when error is detected. The signal of the bit register could be used to trigger a procedure for correcting the error.

13.30 Timer

Overview

Use timer variables to enable timer instructions. Timer variables consist of the following six special variables.

Timer Variable	Variables Type	Description
Input bit (IN)	Bit type	The master switch of timer.
Measurement bit (TI)	Bit type	Turn ON when the timer begin counting.
Output bit (Q)	Bit type	Activate when the timer finish counting.
Preset time (PT)	Word type	Set the timer value.
Elapsed time (ET)	Word type	Display current elapsed value of timer.
Reset bit (R)	Bit type	Reset the elapsed time (ET) to 0.

Configuration

Click the “Timer” icon , “Timer object properties” dialogue box appears as follows:

New Timer Object

Timer

Description :

Mode : Accumulated OFF delay Time base : 0.1 second(s)

Input bit (IN)
 PLC name : Local HMI
 Address : LB 0

Measurement bit (TI)
 PLC name : Local HMI
 Address : LB 1

Output bit (Q)
 PLC name : Local HMI
 Address : LB 2

Preset time (PT)
 PLC name : Local HMI
 Address : LW 0 16-bit Unsigned

Elapsed time (ET)
 Enable
 PLC name : Local HMI
 Address : LW 1 16-bit Unsigned

Reset bit (R)
 PLC name : Local HMI
 Address : LB 3

OK Cancel Help

Mode	Description
On delay	<p>Point 1: When the IN turns ON, the TI be turned ON and the elapsed time ET increases. The Q remains OFF.</p> <p>Point 2: When the ET equals the PT, the Q</p>

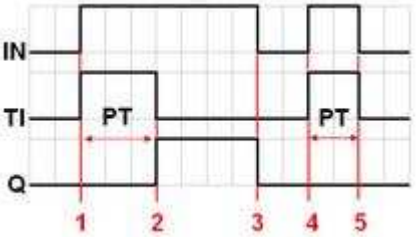
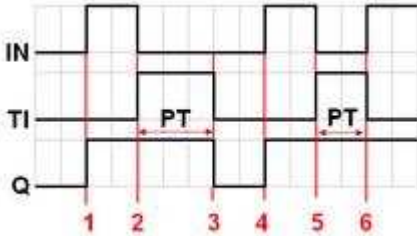
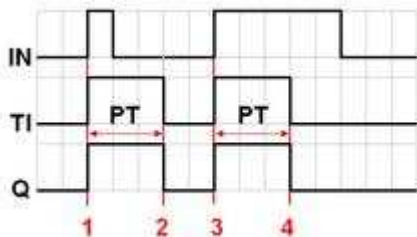
	<p>be turned ON and the TI be turned OFF.</p> <p>Point 3: When the IN turns OFF, the Q be turned OFF and the ET reset to 0.</p> <p>Point 4: When the IN turns ON, the TI be turned ON and the elapsed time ET increases.</p> <p>Point 5: Turn the IN to OFF before the ET reaches the PT, the TI be turned OFF, and the ET reset to 0. (the Q remains OFF)</p>
<p>Off delay</p> 	<p>Point 1: When the IN turns ON, the TI remains OFF and the Q be turned ON.</p> <p>Point 2: When the IN turns OFF, the TI be turned ON and the elapsed time ET increases. (the Q remains ON)</p> <p>Point 3: When the ET equals the PT, the Q and TI are turned OFF.</p> <p>Point 4: When the IN turns ON, the Q be turned ON and the ET reset to 0.</p> <p>Point 5: When the IN turns OFF, the TI be turned ON and the elapsed time ET increases. (the Q remains ON)</p> <p>Point 6: Turn the IN to ON before the ET reaches the PT, the TI be turned OFF, and the ET reset to 0. (the Q remains ON)</p>
<p>Pulse</p> 	<p>Point 1: When the IN turns ON, the TI and Q are turned ON, and the elapsed time ET increases.</p> <p>Point 2: When the ET equals PT, the TI and Q are turned OFF.</p> <p>Point 3: When the IN turns ON, the TI and Q</p>

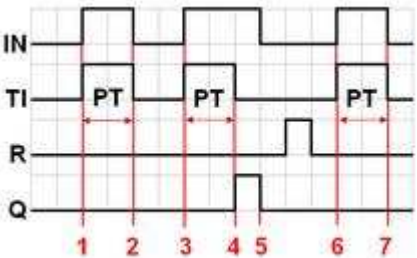
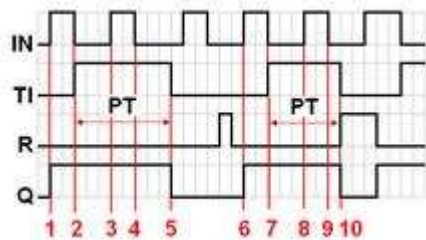
	<p>are turned ON, and the elapsed time ET increases.</p> <p>Point 4: When the ET equals the PT, the TI and Q are turned OFF.</p>
<p>Accumulated On delay</p> 	<p>Point 1: When the IN turns ON, the TI be turned ON and the elapsed time ET increases. (the Q remains OFF)</p> <p>Point 2: When the IN turns OFF, and if the ET is less than the PT, the TI be turned OFF. The ET is in the retentive state.</p> <p>Point 3: When the IN turns ON, the TI be turned ON. The timer measurement starts again and the ET is added to the kept value. The Q remains OFF.</p> <p>Point 4: When the ET reaches the PT, the TI be turned OFF and the Q be turned ON.</p> <p>Point 5: When the IN turns OFF, the Q be turned OFF. (Reset the ET to 0 by using Reset bit (R).)</p>
<p>Accumulated Off delay</p> 	<p>Point 1: When the IN turns ON, the Q be turned ON and TI remains OFF.</p> <p>Point 2: When the IN turns OFF, the TI be turned ON and the elapsed time ET increases. (the Q remains ON)</p> <p>Point 3: When the IN turns ON, the timer measurement pauses.</p> <p>Point 4: When the IN turns OFF, the paused timer measurement continues.</p> <p>Point 5: When the ET equals the PT, the TI and Q are turned OFF. (Reset the ET to 0 by using Reset bit (R).)</p>

13.31 Video In

MT8000X series provide Video Input function. Users can install surveillance camera, then monitor the factory any time they want. The video images can also be stored in devices and play them with Media Player, or analyze them on PC.

This function can be utilized in different aspects. Apart from monitoring factory, it can also be used in driving device or Building Automation monitoring.

For hardware, MT8000X series provide 2 channels for Video Input. Users can freely switch channels to monitor, and capture images without being influenced when pause playing. The captured images will still be real-time external image input. The supported formats are NTSC and PAL.

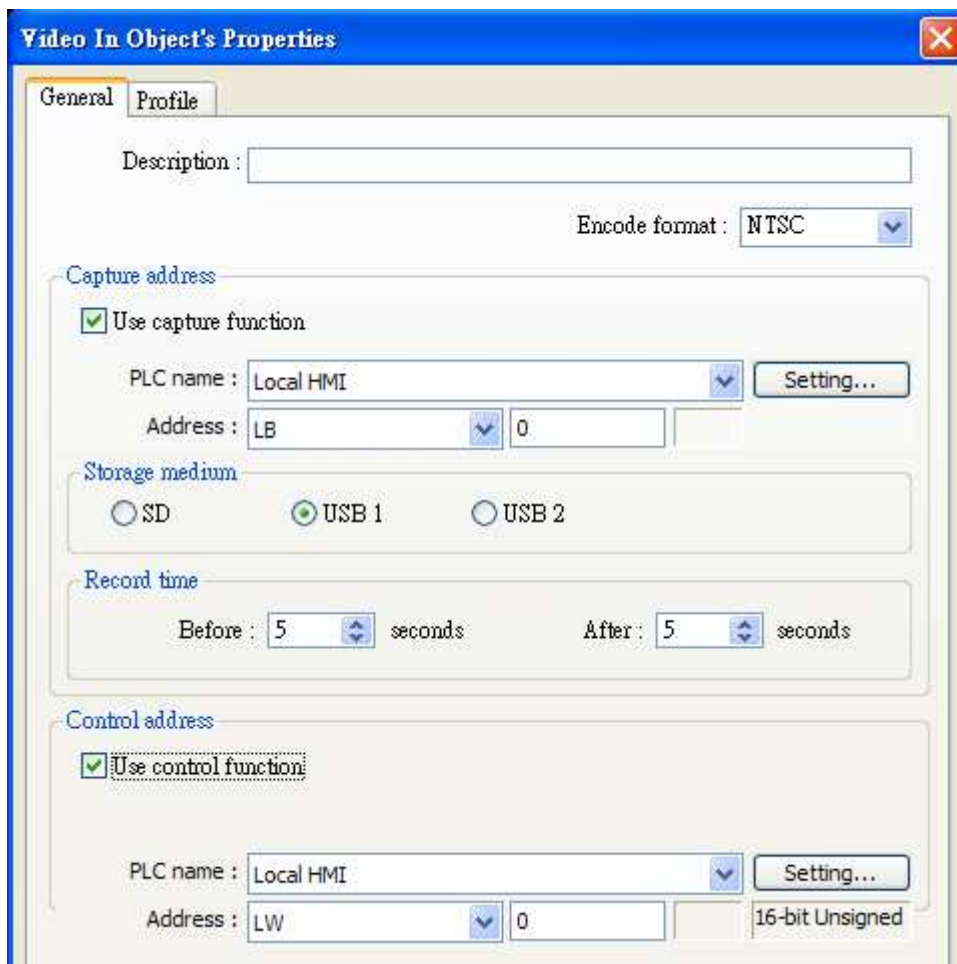

Setting	Description
Use	Definition: For inputting external video image into HMI and play

Control Function

it with HMI.

Illustration:

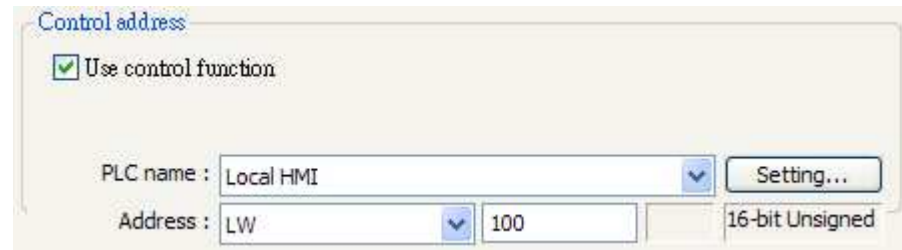

Suppose **[Control Address]** is designated as “LW100”:

- A. Users can set [Control Address+ 0] to enable/stop Video Input function.
 - [LW100] = 0 → Stop Playing.
 - [LW100] = 1 → Input video image in VIP 1 and display it in screen.
 - [LW100] = 2 → Input video image in VIP 2 and display it in screen.
 - [LW100] = 3 → Input video image in VIP 1 but don't display it in screen. In this way users can still execute Capture image.
 - [LW100] = 4 → Input video image in VIP 2 but don't display it in screen. In this way users can still execute Capture image.
- B. Users can set [Control Address +1] to control the displaying of video image:
 - [LW101] = 1 → Pause/Continue playing.
- C. If users change value in [Control Address + 0], the system will keep the new value.
- D. If users change value in [Control Address + 1], system will execute the corresponding command first then erase the new value and set it back to “0”.
- E. If not using **[Control Function]**, system will play the channel set in **[Input channel]** automatically.

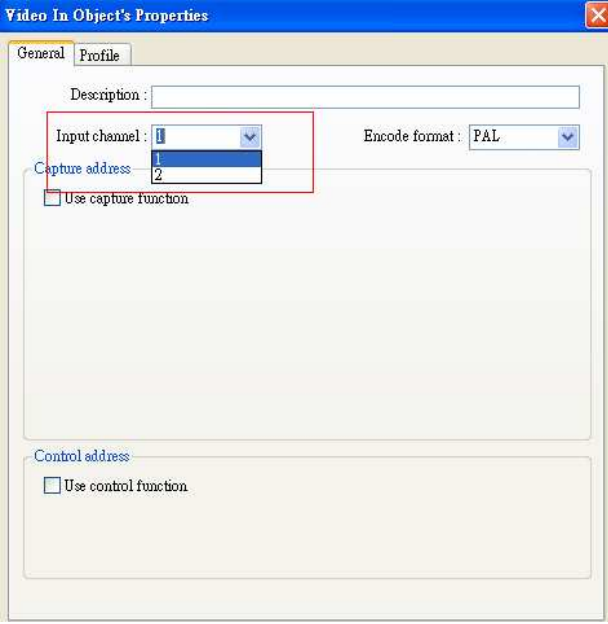
	
<p>Use Capture Function</p>	<p>Definition: Capture the image of the input video.</p> <p>Illustration:</p> <p>A. [Capture address] the Control Address that triggers system to capture the image of video.</p> <p>B. [Storage medium] To choose where to save the video image. Available storage: SD card, USB1 or USB2.</p> <ul style="list-style-type: none"> - VIP 1 video image will be saved in file VIP 1 in the chosen storage and VIP 2 video image in file VIP2. <p>C. [Record time] To set a period of time for image capturing.</p> <ul style="list-style-type: none"> - The longest period can be set starts from 10 seconds before triggering [Capture address] to 10 seconds after triggering. In this case there will be 21 images captured, including the one captured at the triggering moment. - The time interval for capturing is once in each second. - The captured .jpg file will be named in the following format: Before or after [Capture address] is triggered: YYYYMMDDhhmmss.jpg The moment that[Capture address] is triggered: YYYYMMDDhhmmss@.jpg

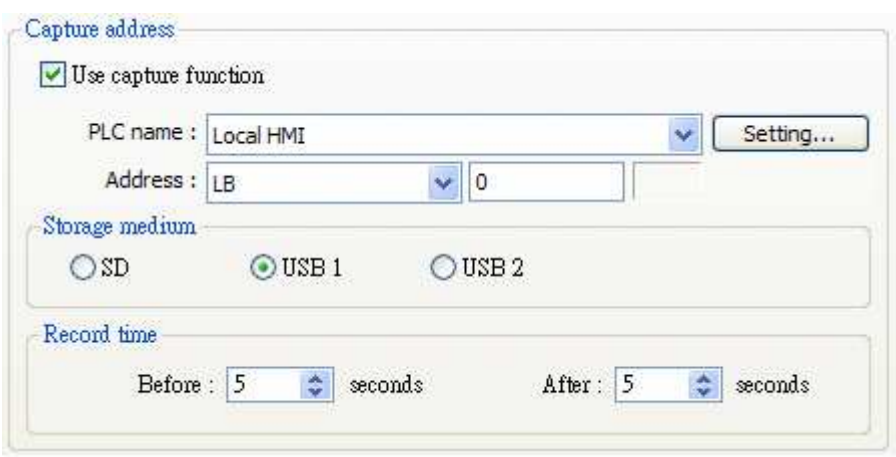

Take the illustration above as sample, set **[Record time]** “Before” and “After” to “5” seconds, when **[Capture address]** changes from OFF to ON, system will be triggered to capture , one image each second, from 5 seconds before the triggering time to 5 seconds after the triggering time.

Note:

1. Video In Object can only be used in MT8000X which supports VIP function.
2. Only video image in one channel can be input at any moment while running system.
3. Capture function won't be influenced by “pause” playing. The video image that should be played while not paused will still be captured.
4. Recommended Format and Resolution:

	1:1	50%
NTSC	720 x 480	360 x 240
PAL	720 x 576	360 x 288

This function only supports NTSC and PAL format.

13.32 System Message

Use this utility to edit messages that displays in popup message boxes.

System Message

Confirmation required

Message : Please confirm the operation Use label library

OK : OK Use label library

Cancel : Cancel Use label library

Font : Arial

Deny write-command

Message : The system is being prohibited from writing device registers!

Font : Arial Use label library

Allow write-command

Message : The system is now allowed to write device registers.

Font : Arial Use label library

OK Cancel

Setting	Description
Confirmation required	<p>Display whenever security requires the user to confirm operation.</p> <p>The [Message] shown on confirmation dialogue, and the text label of the 2 buttons [OK] and [Cancel], can all be set. Please use the same font for the labels of [Message], [OK] and [Cancel]. Additionally, only when selecting</p>

[Label Library] for [Message], the use of Label Library for [OK] and [Cancel] buttons can be enabled.

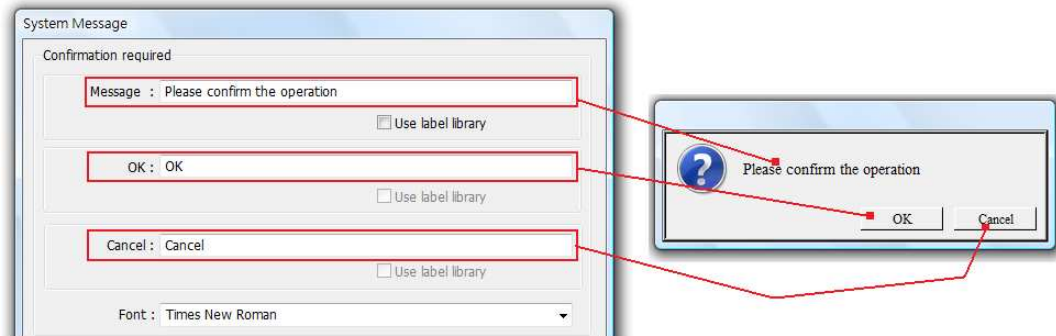

**Deny
write-command**

Display when system tag LB-9196 (local HMI supports monitor function only) is turned ON.

**Allow
write-command**

Display when system tag LB-9196 (local HMI supports monitor function only) is turned OFF.

Chapter 14 Shape Library and Picture Library

EB8000 provides Shape Library and Picture Library features to add visual effects on objects. Each Shape and Picture includes up to 256 states. This chapter expatiates on how to create Shape Library and Picture Library.

For usage of shape and picture library, please refer to “Chapter 9 Object General Properties”.

14.1 Creating Shape Library

A shape is a graph composed of lines, rectangles, and circles. A complete Shape can possess more than one state, and each state can include two parts: frame and inner. See the illustration below:

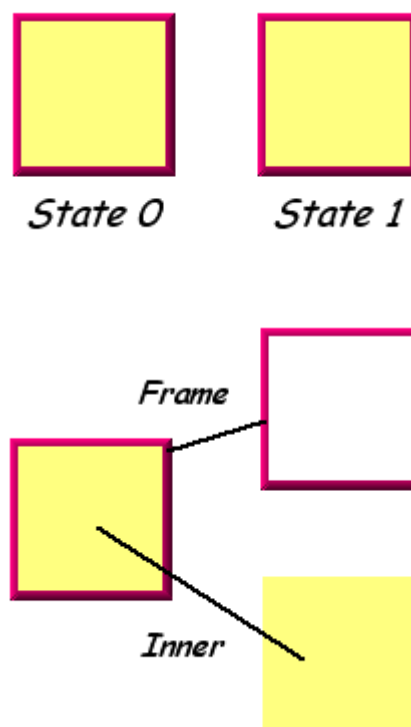

The frame and inner of a shape can be used separately or together by an object. Click **[Call up Shape Library]**, and the **[Shape Library]** dialogue appears as below:

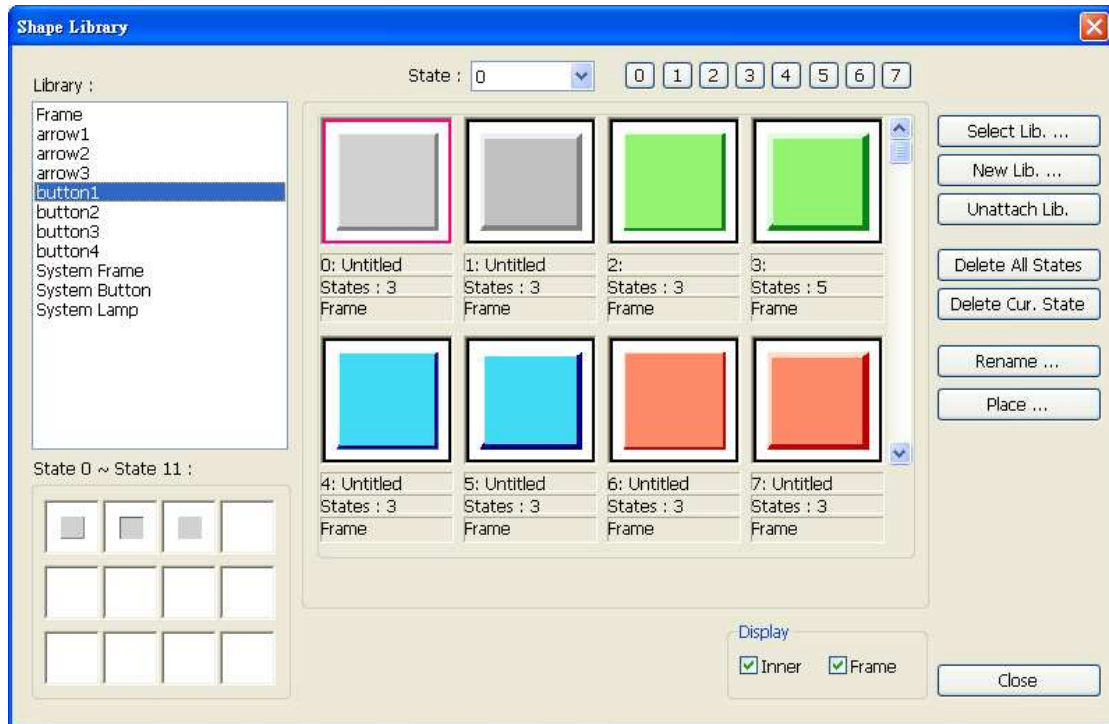
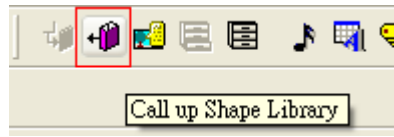

Setting	Description
Library	Shape Libraries which have been added into the current project. Select the library source of a Shape from the list.
State	Select the state to be displayed by current Shape. If the selected Shape isn't displayed, it means that the Shape does not exist or the state of the Shape isn't defined.
Select Lib.	Click [Select Lib.], and the following dialog appears for users to select the file path of the Shape Library to be added. By previewing the content of the library right side of the window, users can select suitable library.

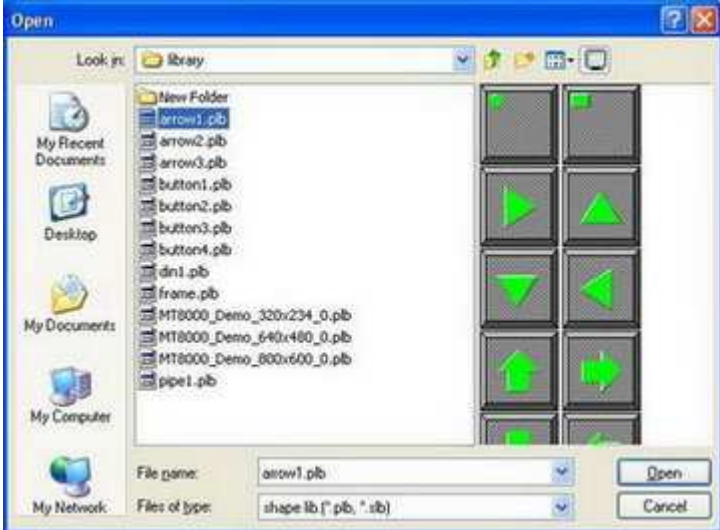
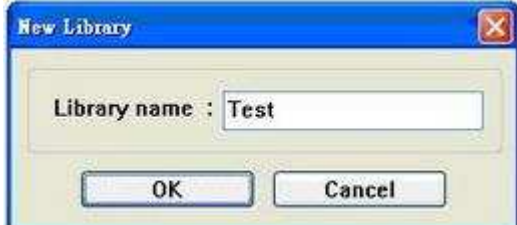
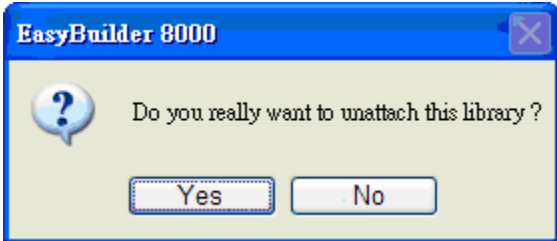
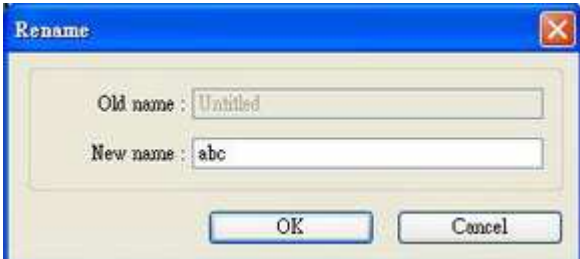
	
New Lib.	Click the button to add a new Shape Library. 
Unattach Lib.	Click the button to delete the Shape Library in [Library] from current project. 
Delete All States	Delete all states of the selected Shape.
Delete Cur. State	Delete current state of the selected Shape.
Rename	Rename the selected Shape. 
Place	Export the Shape to be placed to current window.

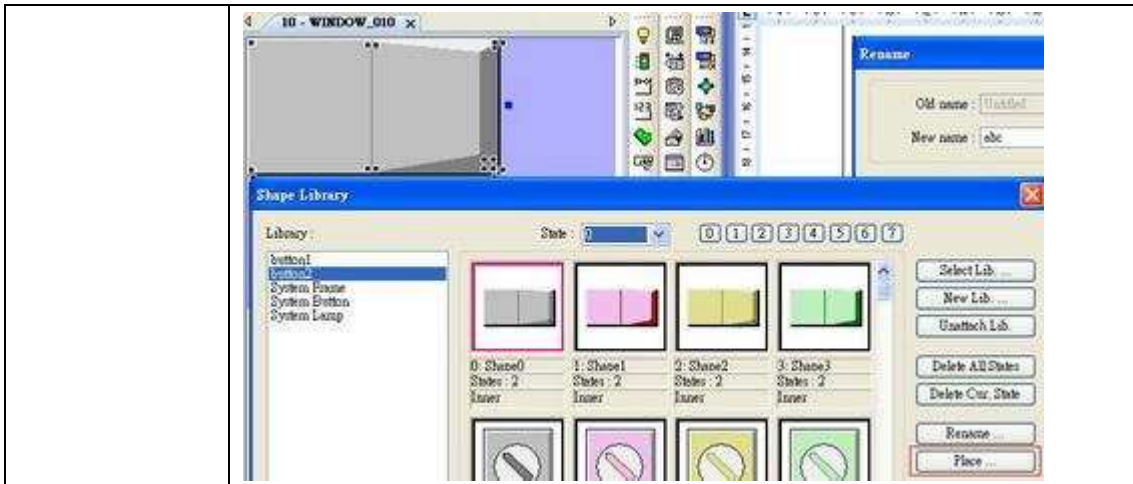

The following shows how to create a new Shape Library and add a Shape with two states to it.

Step 1

Click **[New Lib.]** and input the name of the new Shape Library.

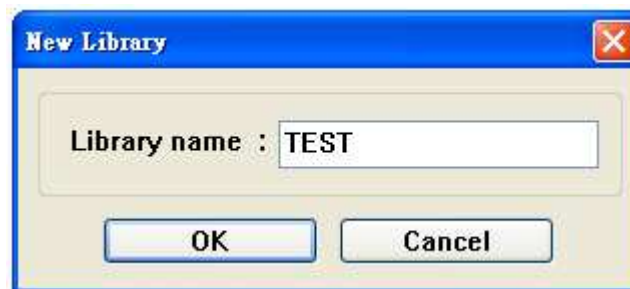

A new Shape Library “TEST” will be added to the **[Shape Library]** dialogue. At this moment, no Shape is in the library.

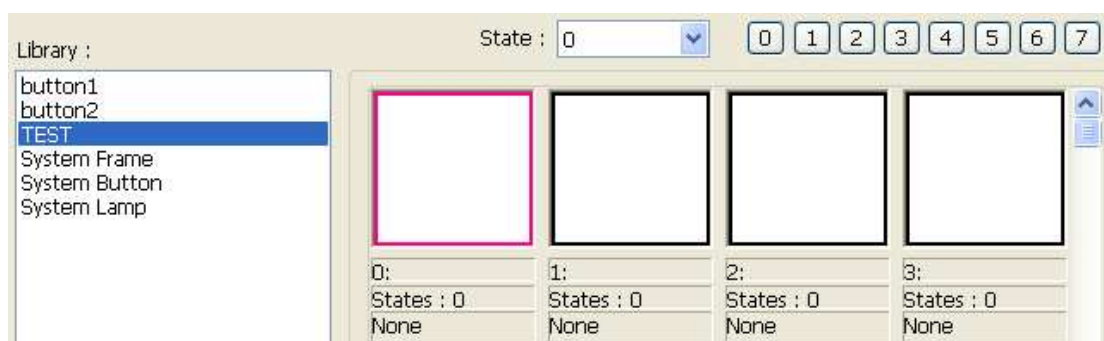

Step 2

Add a state to the selected Shape. First, use the drawing tools to draw a graph in the window and select the graph to be added to the Shape Library.

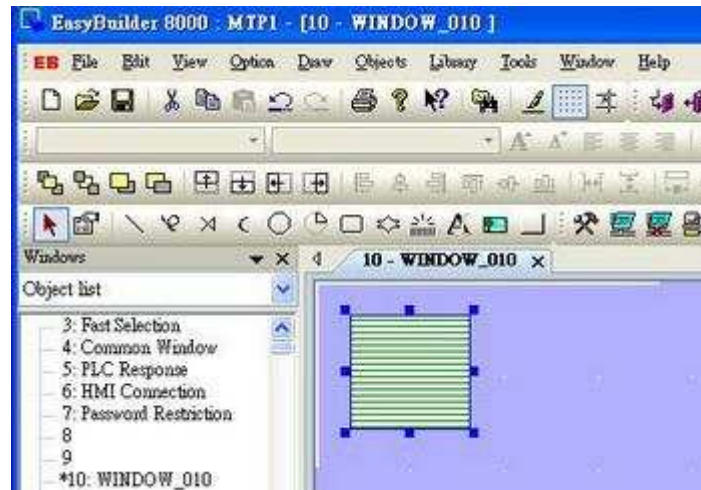

Click the **[Save to Shape Library]** button in toolbar and the following dialogue appears.

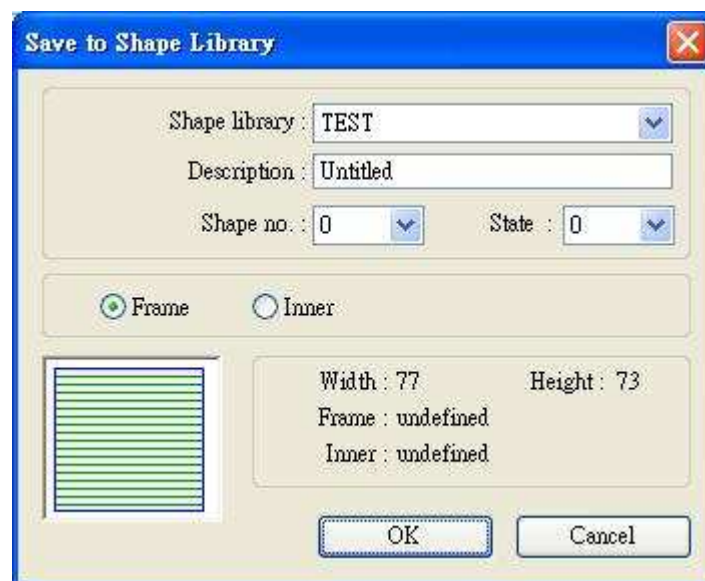

Setting	Description
Shape library	Select the Shape Library for the graph to be added to. In this example, "TEST" library is selected.
Description	The name of the Shape.
Shape no.	The number in Shape Library current graph will be added in.

State	Select the state of the Shape which this graph represents. In this case the state is set "0". EB8000 provides 256 states for each Shape.
Frame	If [Frame] is selected, the graph will become a frame of the Shape.
Inner	If [Inner] is selected, the graph will become an inner part of the Shape.

This part shows the current status of the shape, at this moment shape [no. 0] in **[state 0]** in library "Test" is with undefined frame and inner.

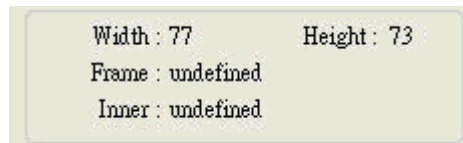

After clicking **[OK]**, the graph will be added to Shape Library. Illustration below shows that Shape **[No.0]** in library "Test" has only one state, **[state0]**, and is defined as a frame.



Step 3

Likewise, create another Shape state by the same process as in Step 2, but this new graph has to be defined as **[state 1]**:

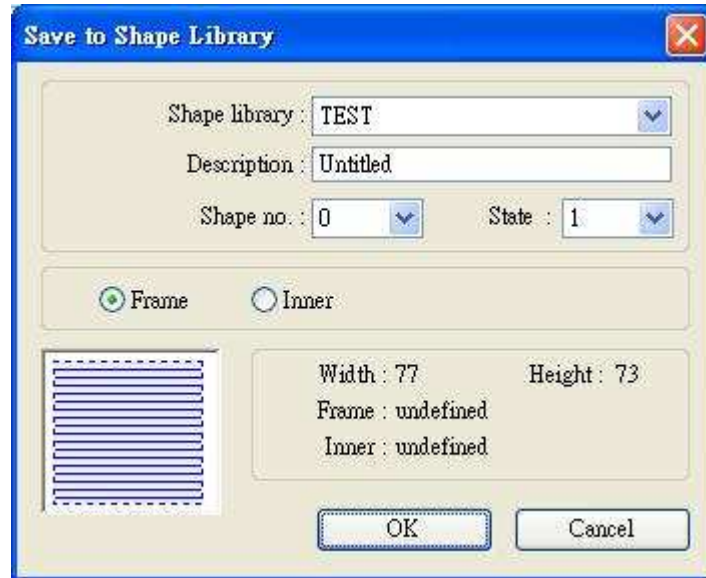

A complete Shape with two states is created. See the following picture.

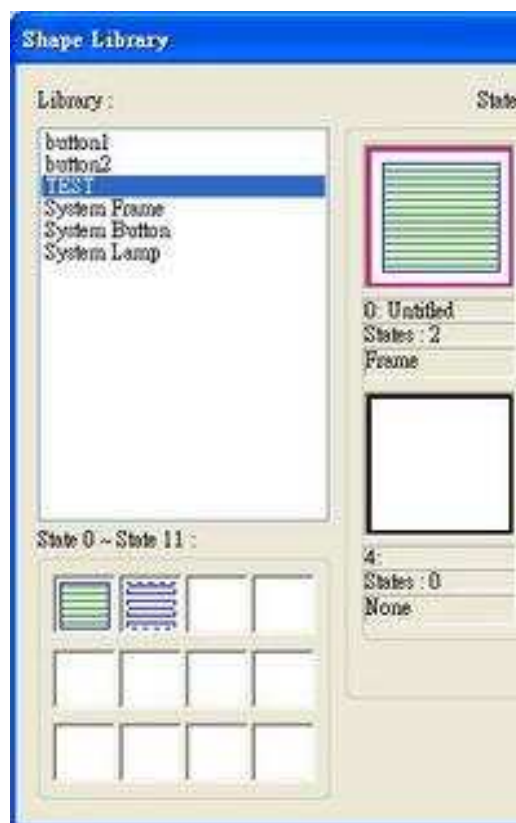

14.2 Creating Picture Library

Click the **[Call up Picture Library]** button in toolbar, and the **[Picture Library]** dialogue appears.

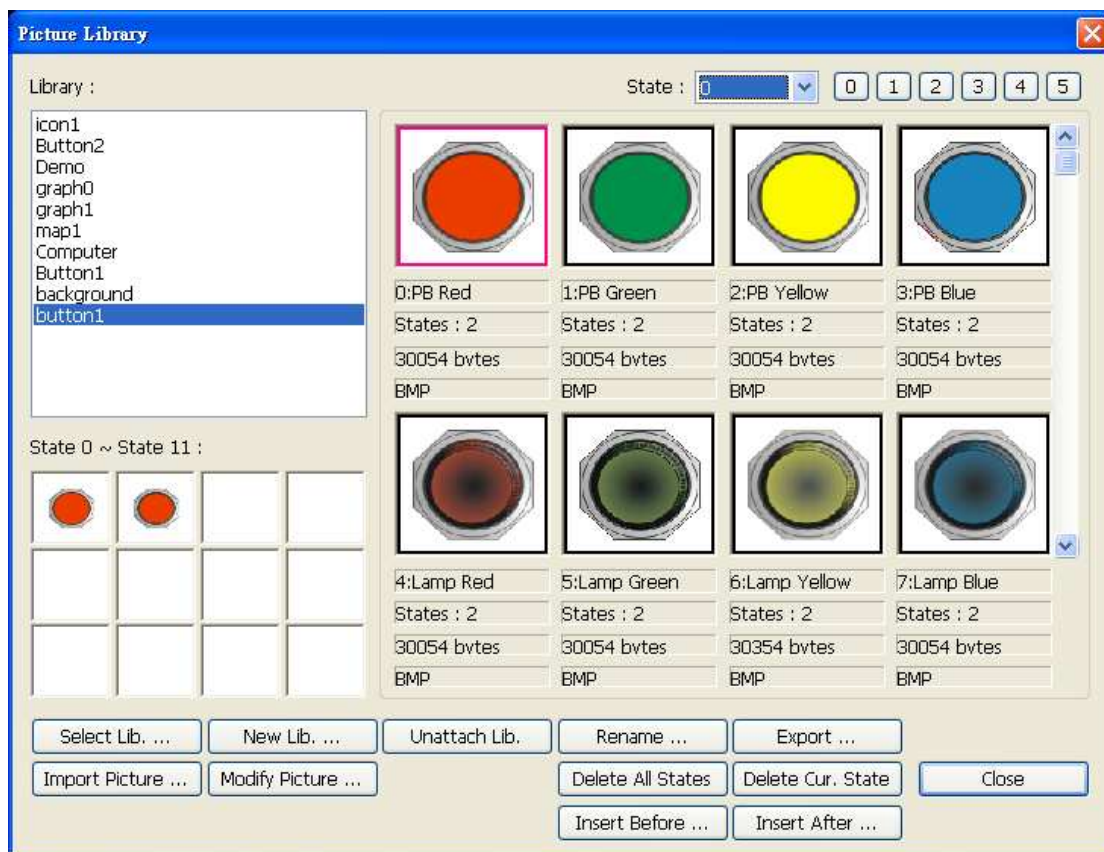
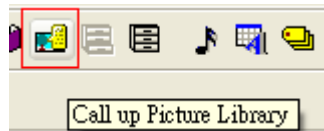

Setting	Description
Library	Picture Libraries which have been added into the current project. Select the library source of a Picture from the list.
State	Select the state that current graph represents. If the selected Picture isn't displayed, it means that the Picture does not exist or the state of the Picture isn't defined.
Select Lib.	Click [Select Lib. ...] and the following dialog appears for users to select the file path of the Picture Library to be added. By previewing the content of the library right side of the window, users can select suitable library.

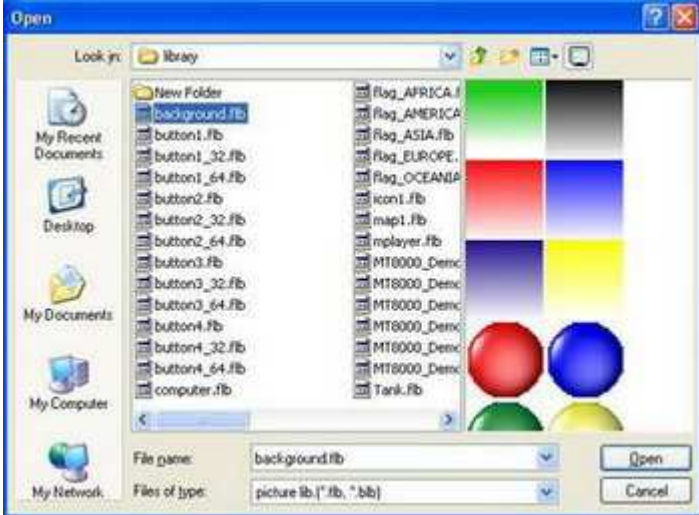
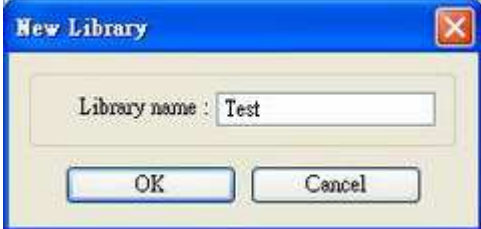
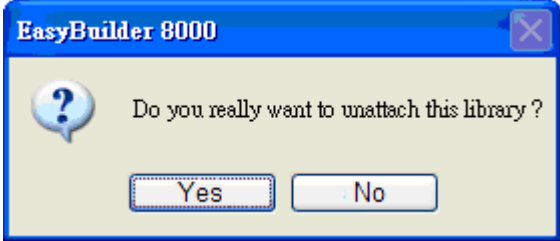
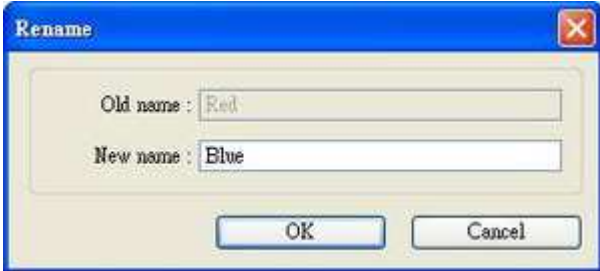
	
New Lib.	Click the button to add a new Picture Library. 
Unattach Lib.	Click the button to delete the Picture Library in [Library] from the current project. 
Delete All States	Delete all states of the selected Picture.
Delete Cur. State	Delete current state of the selected Picture.
Rename	Rename the selected Picture. 
Insert Before	Add a new state before the current state.

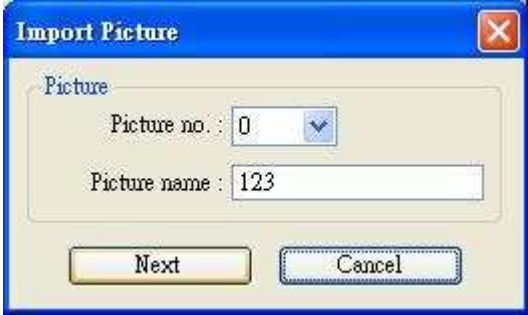
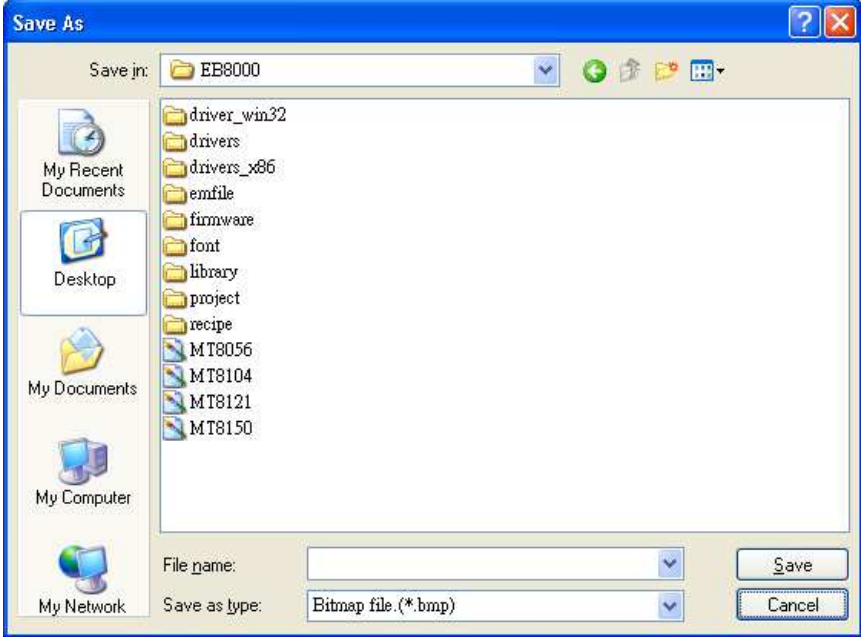
Insert After	Add a new state after the current state.
Import Picture	Add a new picture to the Picture Library. 
Modify Picture	Modify the selected picture.
Export	Export the selected picture to the appointed place. As shown below, users can get the original picture. 

Note: The compatible picture format are *.bmp, *.jpg, *.gif, *.dpd, and *.png. When adding a GIF picture in Picture Library, if this picture file is animated, the number of times to play this animation can be set by users as below.

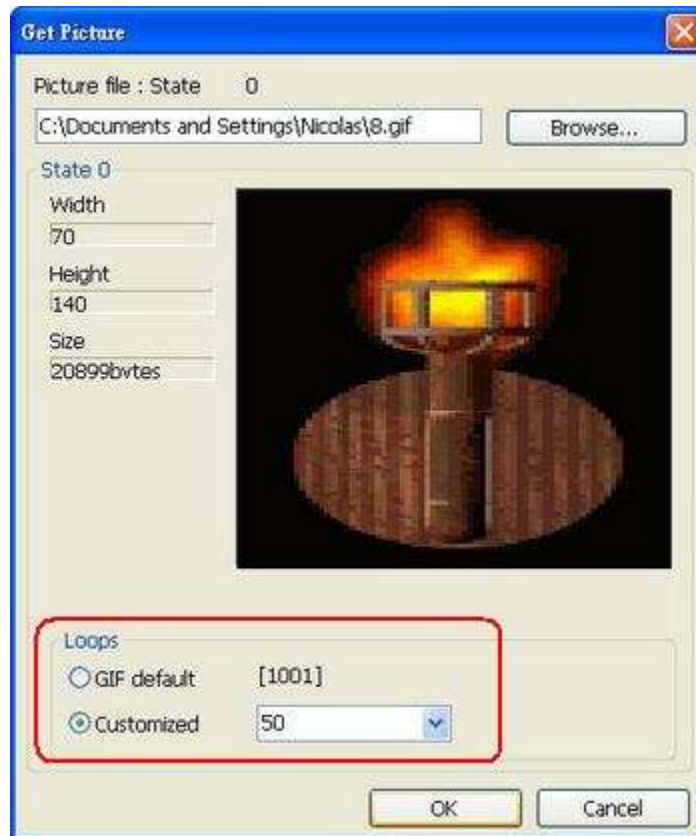

The example below shows how to create a new Picture Library and add a Picture with two states into it.

Step 1

Click **[New Lib.]** and input the name of the new Picture Library.

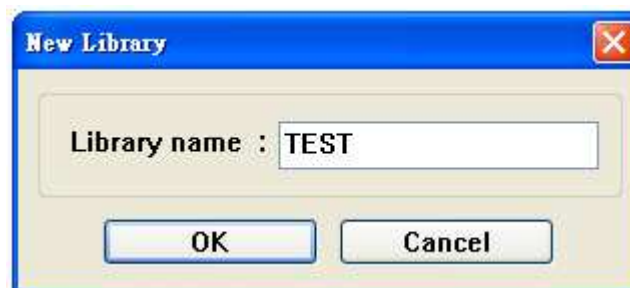

A new Picture Library "TEST" will be added to the **[Picture Library]** dialogue. At this moment, there is no Picture in the library.

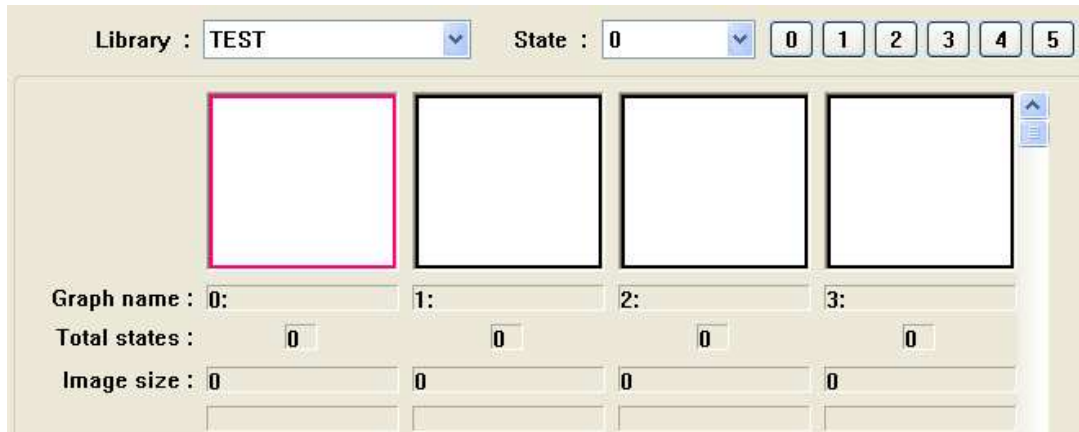

Library : TEST State : 0 0 1 2 3 4 5

Graph name : 0: 1: 2: 3:

Total states : 0 0 0 0

Image size : 0 0 0 0

Step 2

Prepare the pictures to be added; suppose the two graphs below are used to represent state 0 and state 1 respectively.

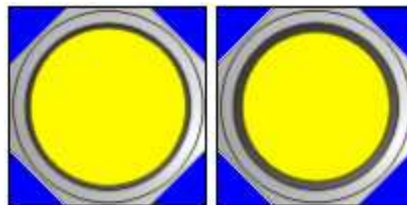

Click **[Import Picture]** and a dialogue appears as below. Set **[Picture no.]** and **[Picture name]** for it, and then click **[Next]**.

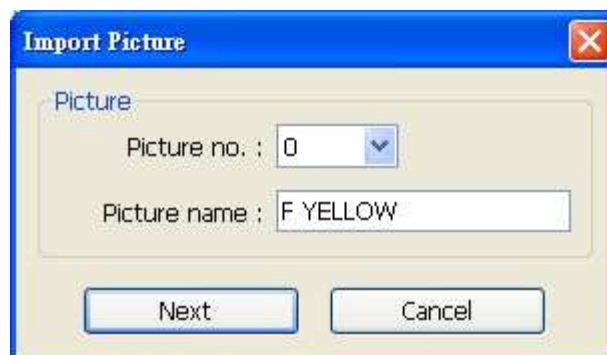

Import Picture

Picture

Picture no. : 0

Picture name : F YELLOW

Next Cancel

Step 3

When the dialogue below is shown, select the source of picture for state 0, and select the correct transparent color. In the example below, the blue color RGB (0, 0, 255) is a transparent color. After the settings of the state 0 are completed, click **[Next]** button to continue the settings of the other state.

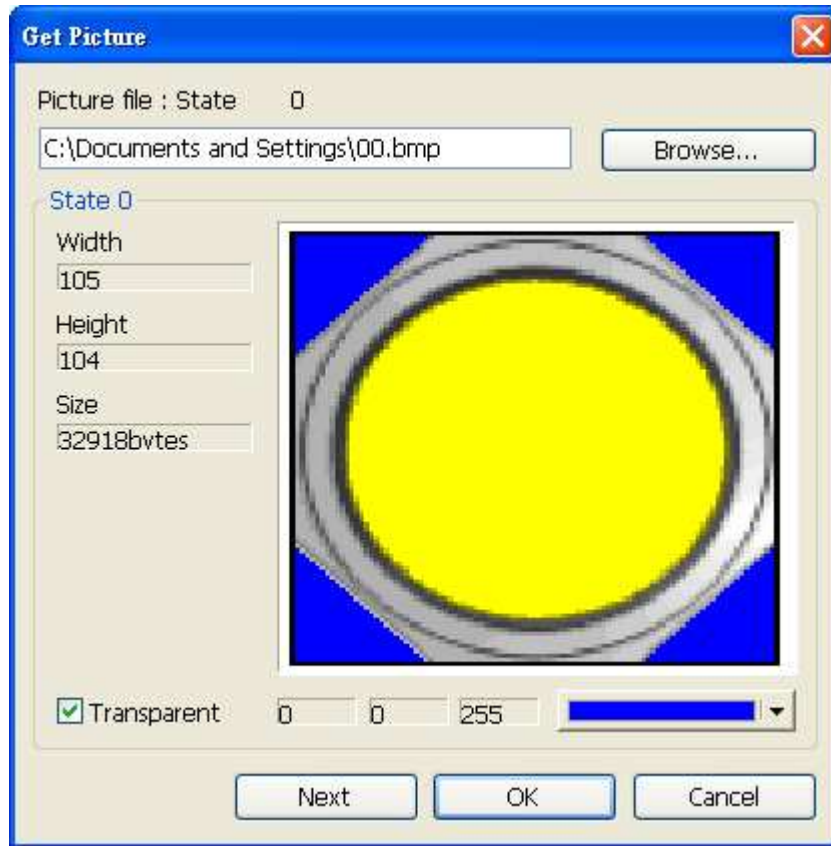

Before choosing transparent color, check **[Transparent]** box first and then left click on location-to-be of the graph. At this time, EB8000 will automatically display RGB value of the transparent color. Take above as an example, the actual shape shown as below:



Step 4

Likewise, select the source of a picture for state 1 and select the correct transparent color for it. After the settings are completed, click the **[Finish]** button.

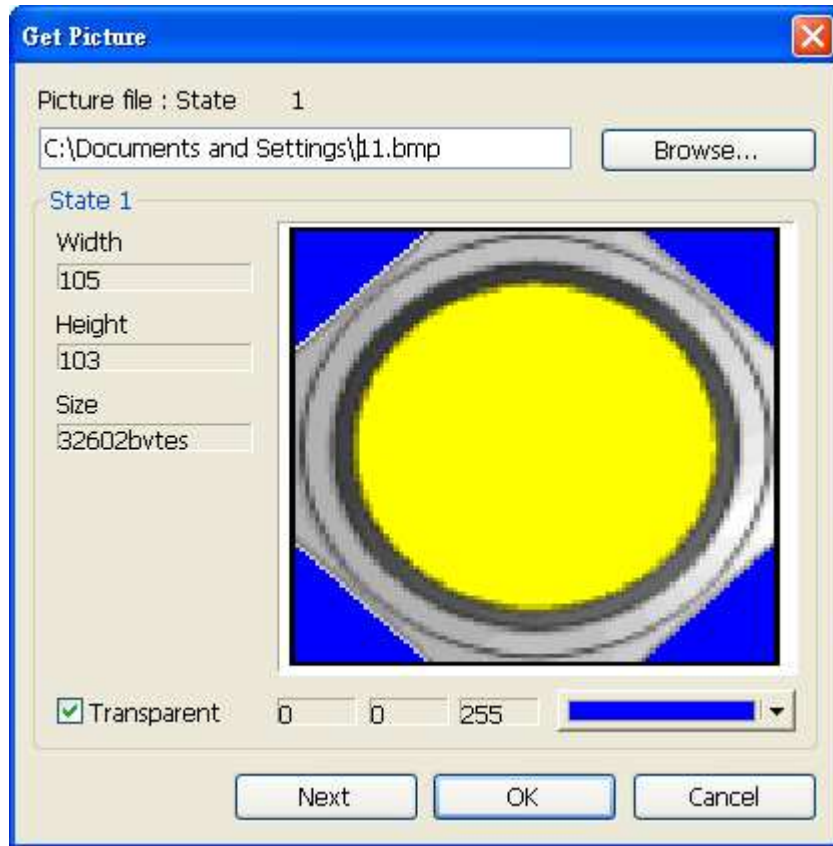

Below shows the complete picture created. A new picture “F Yellow” can be found in the [Picture Library] dialogue. From the information we know the picture is in the format of bitmap and with two states.

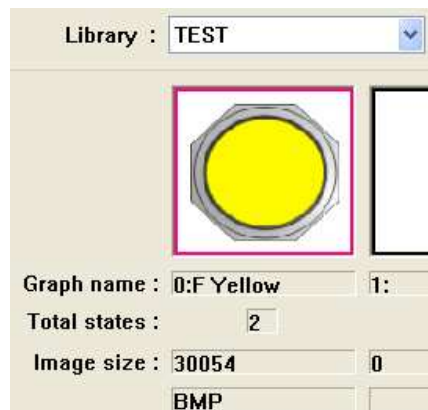

Chapter 15 Label Library and Multi-Language Usage

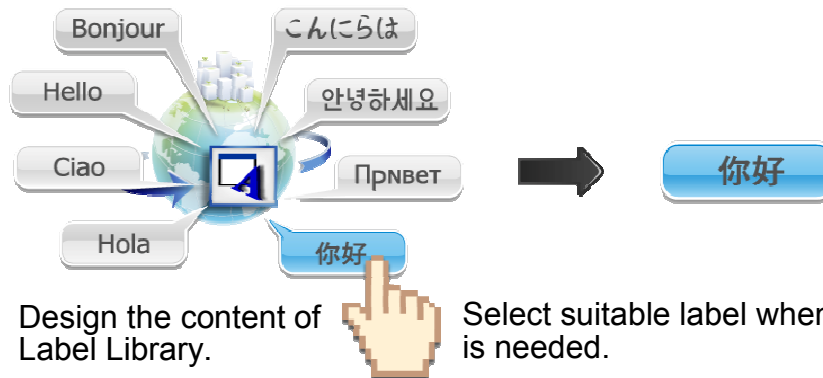

15.1 Introduction

The system in operation will display the corresponding text to the language in use according to the settings. EasyBuilder Pro supports 8 different languages simultaneously.



Click **[Label Library Manager]**

[State no.] indicates the current state. Each Label has maximum of 256 states (state no. 0~255). The State no. is determined by **[Language no.]** selected. If user use 8 languages, $256/8=32$ (states)

Add a new Label.

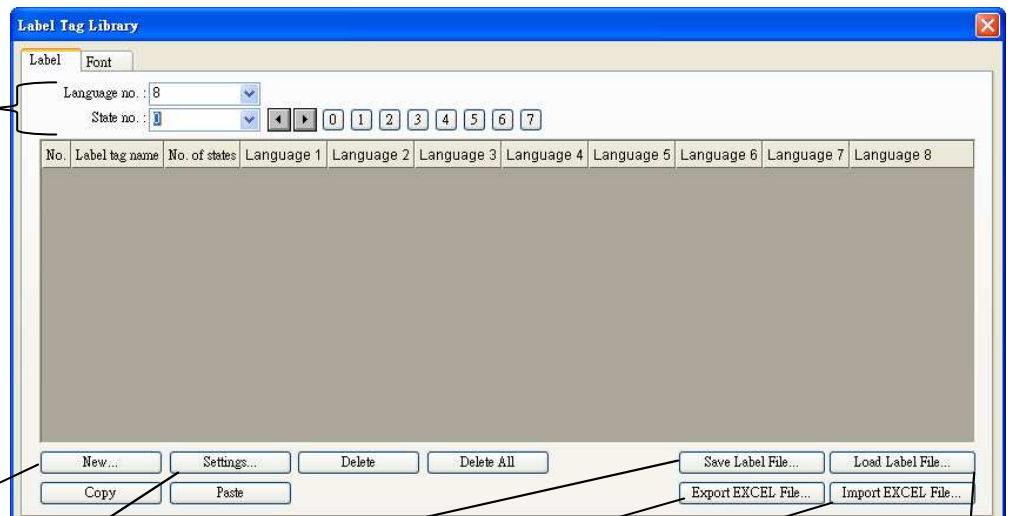

Modify the content of selected Label.

Save all current Labels in *.lbl format.

Export the current Label Library in *.csv or *.xls formats to specified location.

Import a Label Library in *.csv or *.xls formats to the current project *.mtp.

Load existing *.lbl file to Label Library.



UNICODE is not supported when importing and exporting EXCEL file.

15.2 Building Label Library

1. Open  [Label Tag Library] -> [New]

[Label name]

User can specify the name of the Label.

[No. of states]

The number of states can be shown by this Label.



The dialog box titled "Label" contains two input fields: "Label name" with the text "Pump Alarm" and "No. of states" with the value "2". At the bottom, there are "OK" and "Cancel" buttons.

2. Click [OK] a new Label "Pump Alarm" with 2 states will be added to the Label Library, select it and click [Settings].

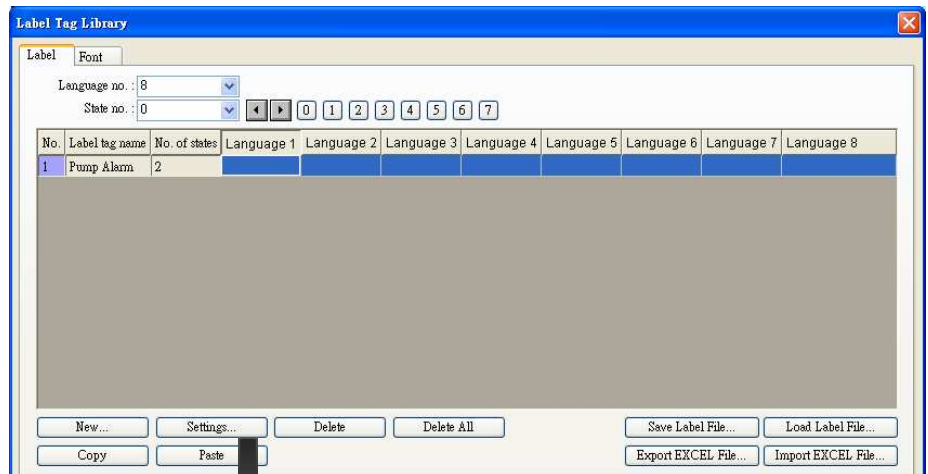

The "Label Tag Library" dialog box shows a table with the following data:

No.	Label tag name	No. of states	Language 1	Language 2	Language 3	Language 4	Language 5	Language 6	Language 7	Language 8
1	Pump Alarm	2								

At the bottom, the "Settings..." button is highlighted with a downward arrow.

3. Set up the corresponding language contents.

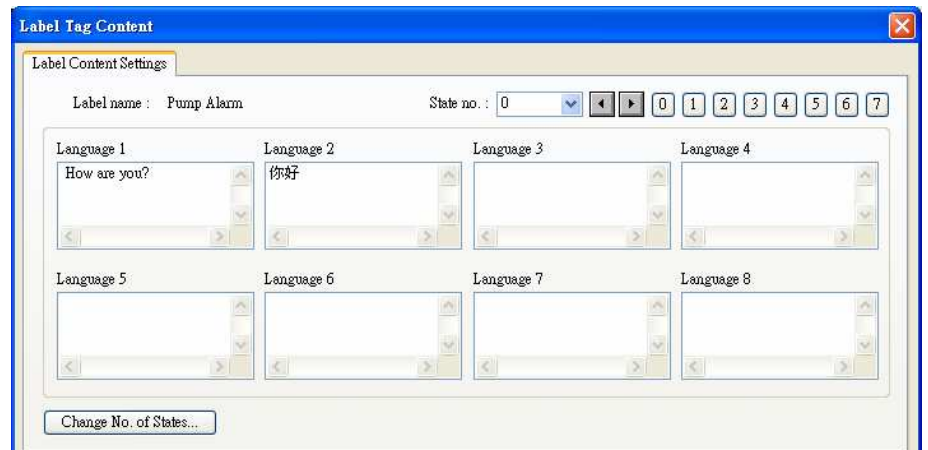

The "Label Tag Content" dialog box shows the "Label Content Settings" for "Pump Alarm". It features eight text input fields for different languages:

- Language 1: How are you?
- Language 2: 你好
- Language 3: (empty)
- Language 4: (empty)
- Language 5: (empty)
- Language 6: (empty)
- Language 7: (empty)
- Language 8: (empty)

A "Change No. of States..." button is located at the bottom.

15.3 Setting Label Font



[Label Tag Library] / **[Font]** see the languages the current Label contains and set the font. Different languages can use different font.



[Font] When using a Label to show different languages, different fonts can be selected for each language.

[Comment]
The memo for each font.

15.4 Using Label Library

When there are already some defined labels in Label Library, users can find those Labels in **[Label tag]** by selecting **[Use label library]** in the object's **[Label]** tab.

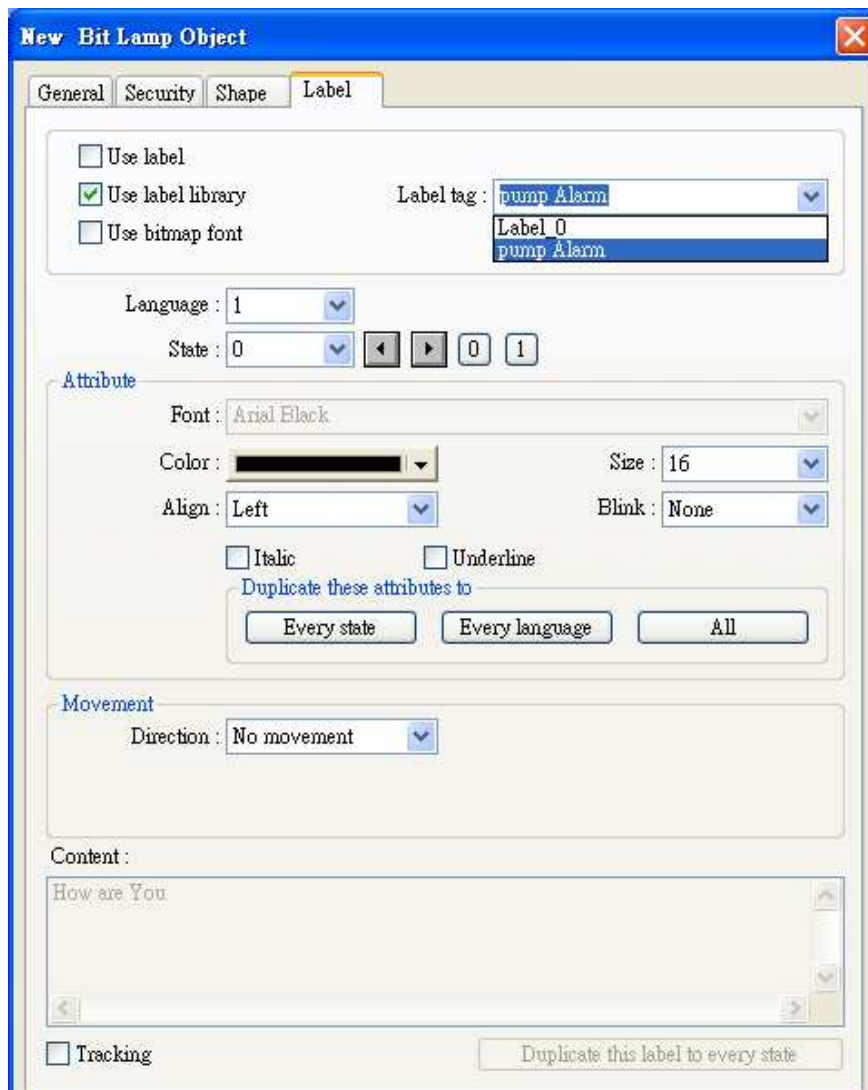

When **[Use label library]** is selected, **[Content]** field shows the content of selected Label Tag and the settings of **[Font]** are also included in the Label Library. Please note that languages 2 ~ 8 can only set the Font **[Size]**, other settings for example: **[Color]**, **[Align]**, **[Blink]** etc. will follow the settings of language 1.

15.5 Settings of Multi-Language (System Register LW-9134)

When users would like to have the object's text to show multi-language, except for using Label Library, the system reserved register [LW-9134]: language mode can be used. The value of [LW-9134] can be set from 0 to 7. Different data of [LW-9134] corresponds to different Languages1 to 8. The way of using [LW-9134] will differ if the languages are not all chosen when compiling and downloading the project.

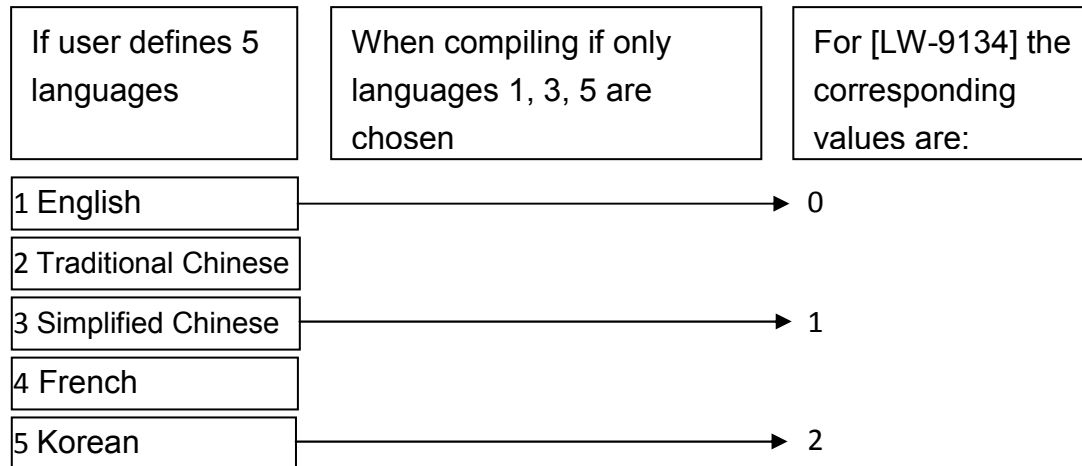

Example 1 How to use multi-language:

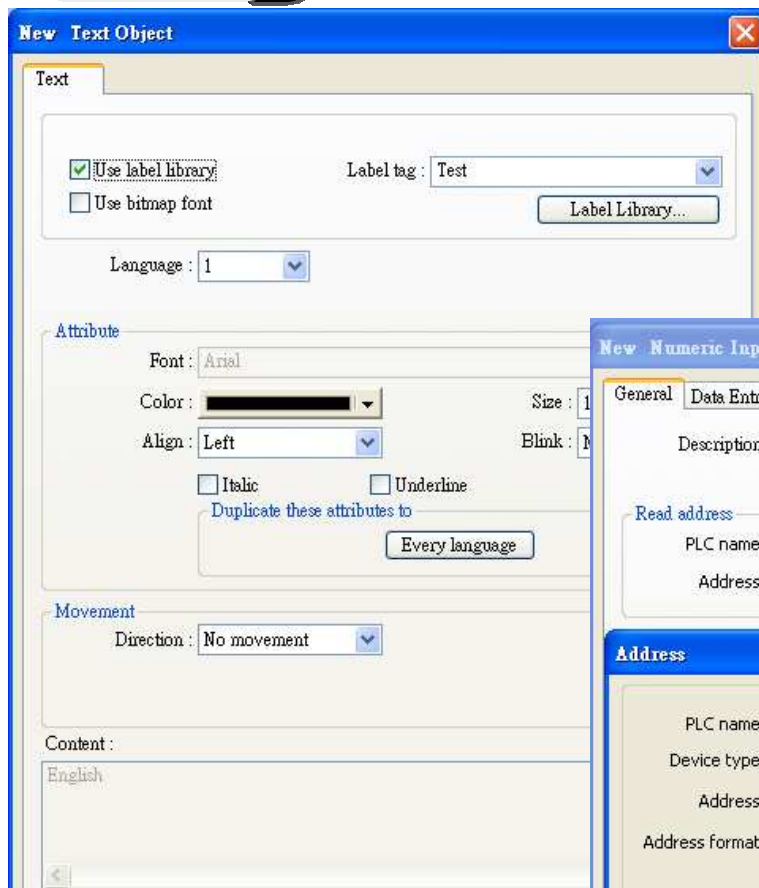

1. Create a "Text" object and tick **[Use Label Library]**.
2. Create a "Numeric Input" and use System Tag **[LW-9134]**.

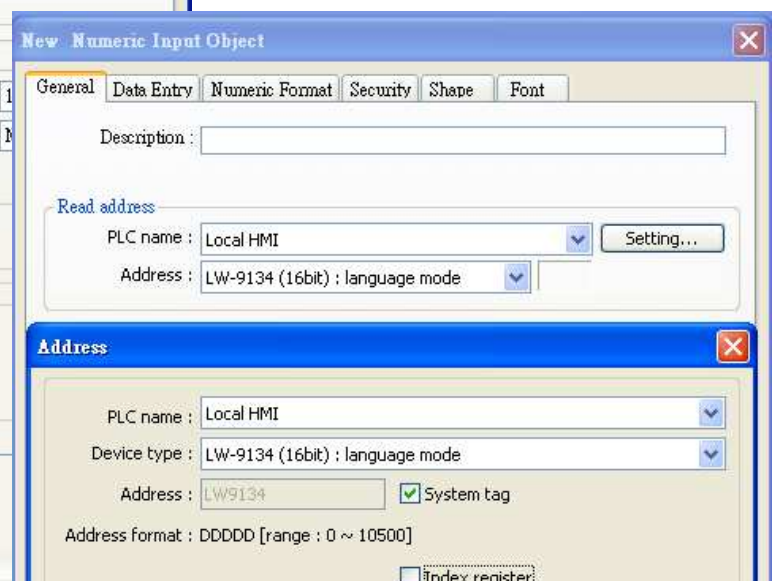



When compiling, tick the defined and needed languages.

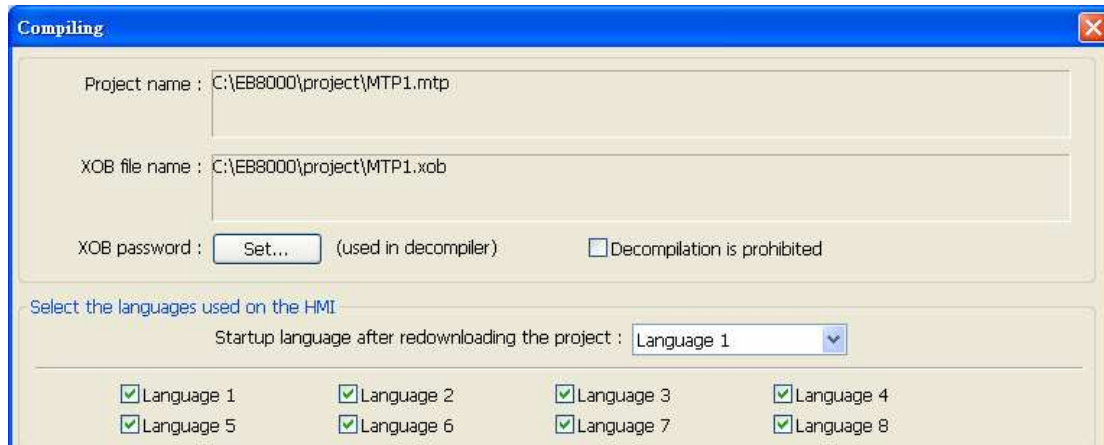

The simulation is shown below, if we change the value of [LW-9134], the content of the “Text” object will be changed.

English

LW9134 : language mode

简体中文 (SIMPLE)

LW9134 : language mode

한국어 웹 (KOREAN)

LW9134 : language mode



Please confirm your internet connection before downloading the demo project.

Chapter 16 Address Tag Library

16.1 Creating Address Tag Library

Users are generally recommended to define commonly-used addresses in the address tag library when start to build a project. It not only avoids inputting addresses repeatedly but also expresses the function of an address more clearly.

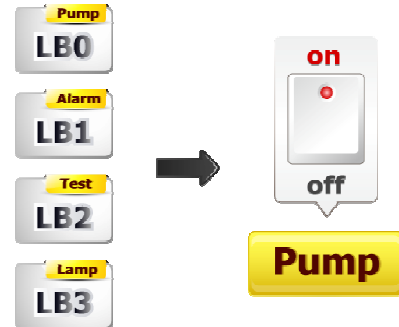

Display
User-defined
address tags

Display
System-reserved
address tags

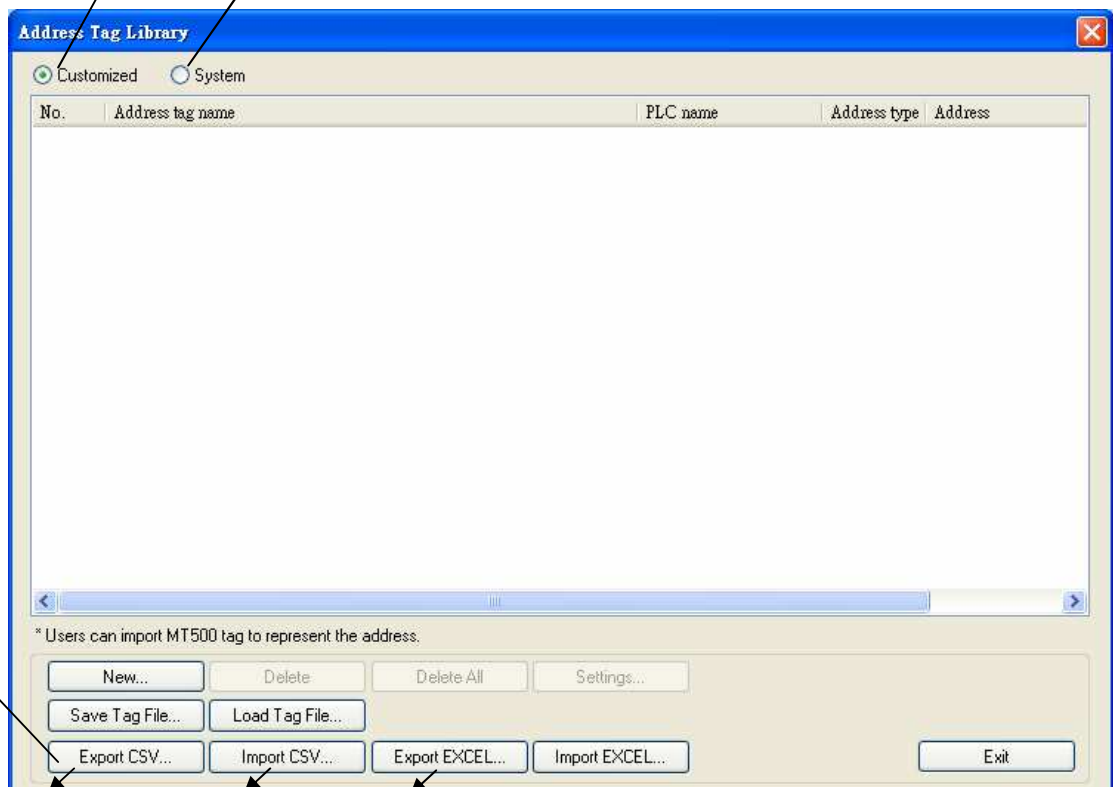

To create a new address tag, **please see next page:**

Save all current address tags as *.tgl file.

Load existing *.tgl file to Address Tag Library.

Export current Address Tag Library to the appointed space in *.csv format.

Import the saved *.csv file of Address Tag Library to current project.

Export current Address Tag Library to the appointed space in *.xls format.

Import the saved *.xls file of Address Tag Library to current project.

Modify the selected address tag.

Click **[New]**

Name of the address tag

Selected from **[Device list]**

The type of address; **[bit]/[word]** types available

The device type; the available types are related to **[PLC name]** & **[Address type]**

Content of the address



The dialog box 'Address Tag' contains the following fields and options:

- Tag name : pump
- PLC name : MITSUBISHI FX0n/FX2
- Address type : Bit Word
- Device type : T
- Address : 20
- Address format : DDD [range : 0 ~ 255]

Buttons: OK, Cancel

Click **[OK]**

A new tag will be found in the **[Customized]** library.

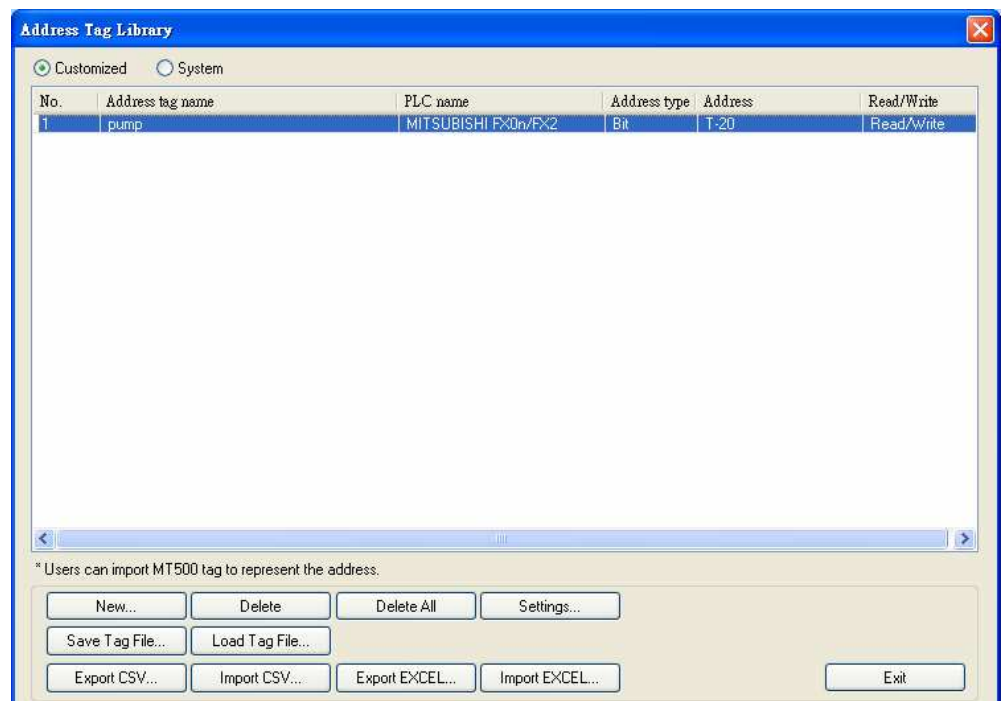

The 'Address Tag Library' dialog box shows a table with the following data:

No.	Address tag name	PLC name	Address type	Address	Read/Write
1	pump	MITSUBISHI FX0n/FX2	Bit	T-20	Read/Write

Buttons: New..., Delete, Delete All, Settings..., Save Tag File..., Load Tag File..., Export CSV..., Import CSV..., Export EXCEL..., Import EXCEL..., Exit

* Users can import MT500 tag to represent the address.

16.2 Using Address Tag Library



1. Define Address Tag Library
2. Create an object, select **[General] / [PLC name]**
3. Click **[Setting]**
4. Tick **[User-defined tag]**
5. From **[Device type]** select the defined tag.
6. Upon completion, the window tree will show the address tag name used for the object.

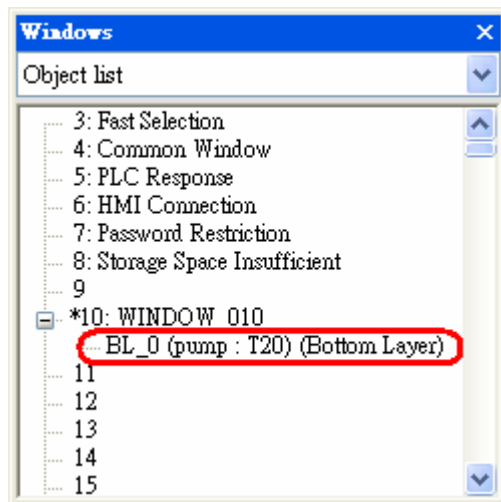

Chapter 17 Transferring Recipe Data

Recipe Data refers to data stored at RW and RW_A addresses. The way of reading and writing Recipe Data is nothing different from operating a word register. The difference is that Recipe Data is stored in flash memory, when restarting HMI, the latest data records in RW and RW_A are kept the same.

The size of Recipe Data in RW is 512K words, and RW_A is 64K words. Users can update Recipe Data with SD Card, USB disk, USB cable or Ethernet and use this data to update data in PLC. Recipe Data can also be uploaded to the designated address; furthermore, PLC data can be saved in recipe memory. The following explains the ways of operating Recipe Data.

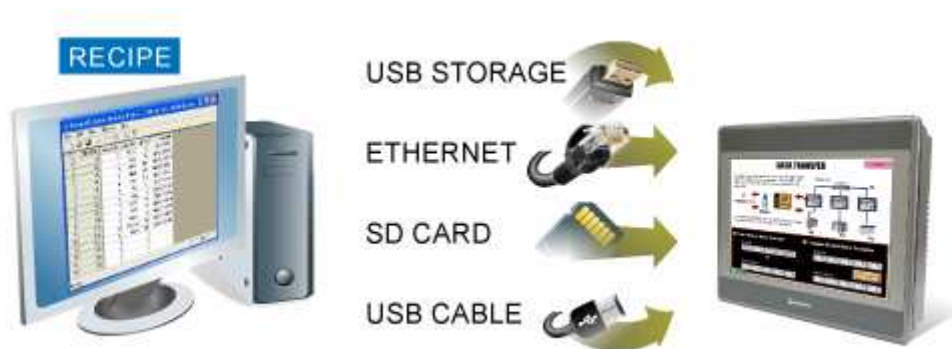

17.1 Updating Recipe Data with Ethernet or USB cable

1. Open Project Manager and click **[Download]**.
2. Select **[RW]** and **[RW_A]** and designate the directory of the source file.
3. After downloading, restart HMI, RW and RW_A will be updated.

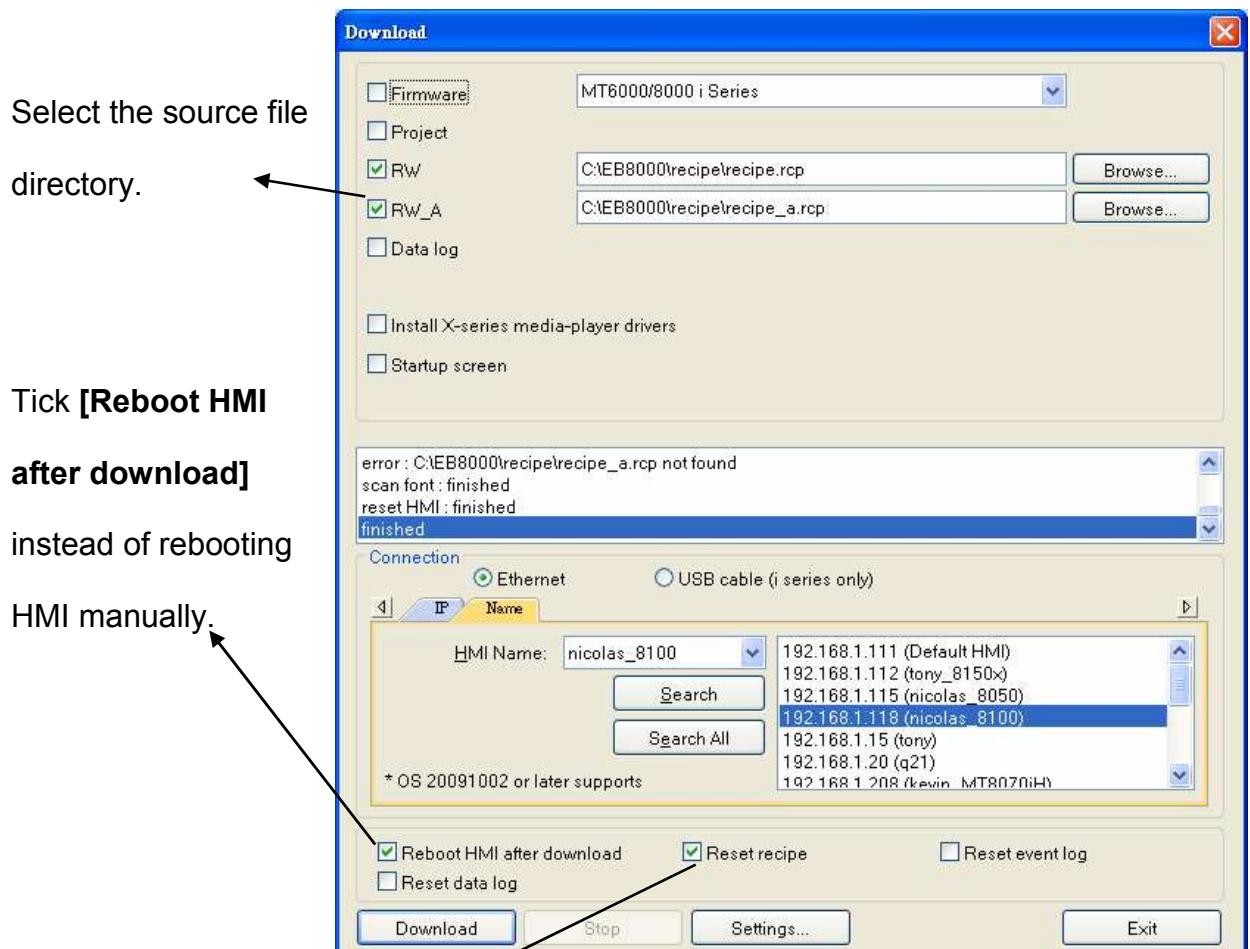

17.2 Updating Recipe Data with CF/SD Card or USB Disk

1. Open Project Manager and click **[Build Download Data for CF/SD Card or USB Disk]**.
2. Insert SD card or USB disk into PC
3. Click **[Browse]** to designate the file path.
4. Click **[Build]**, EasyBuilder Pro will then build the sources into SD card or USB disk.

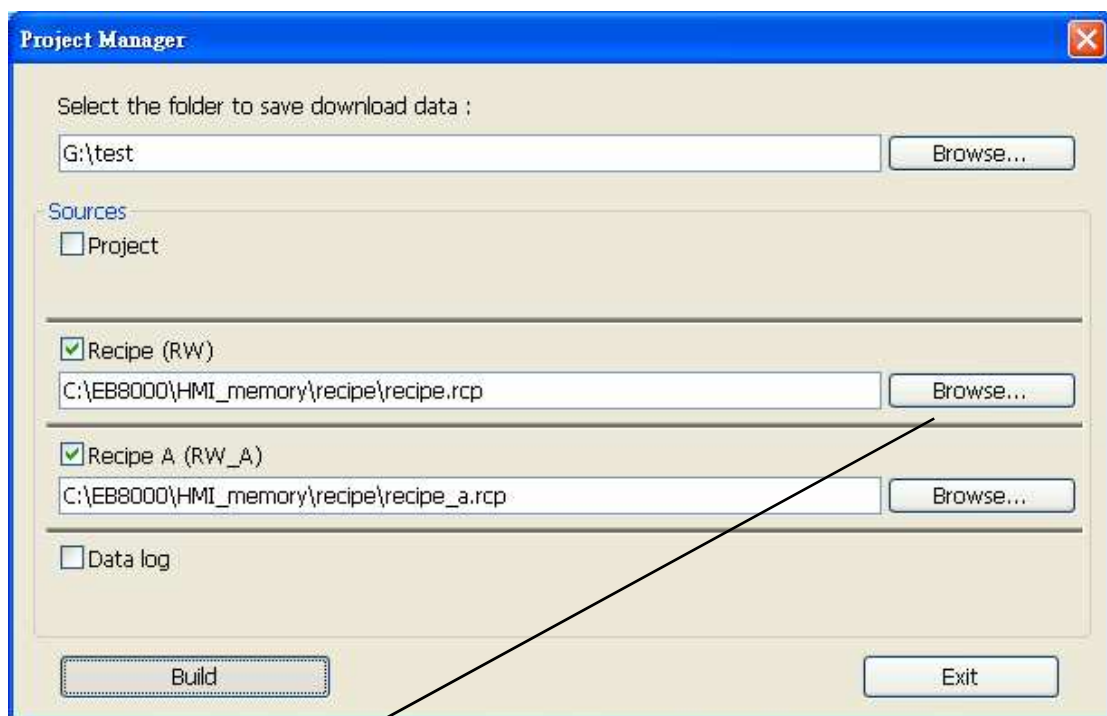

Select the source file directory.



■ When download data is successfully built, two folders can be found: *history* and *mt8000*. *mt8000* is for storing project files; *history* is for storing Recipe Data and Data Sampling / Event Log records.

17.3 Transferring Recipe Data

Use  [Data Transfer (Trigger-based) object] to transfer Recipe Data to the appointed address, or save the data of the designated address to [RW] and [RW_A].

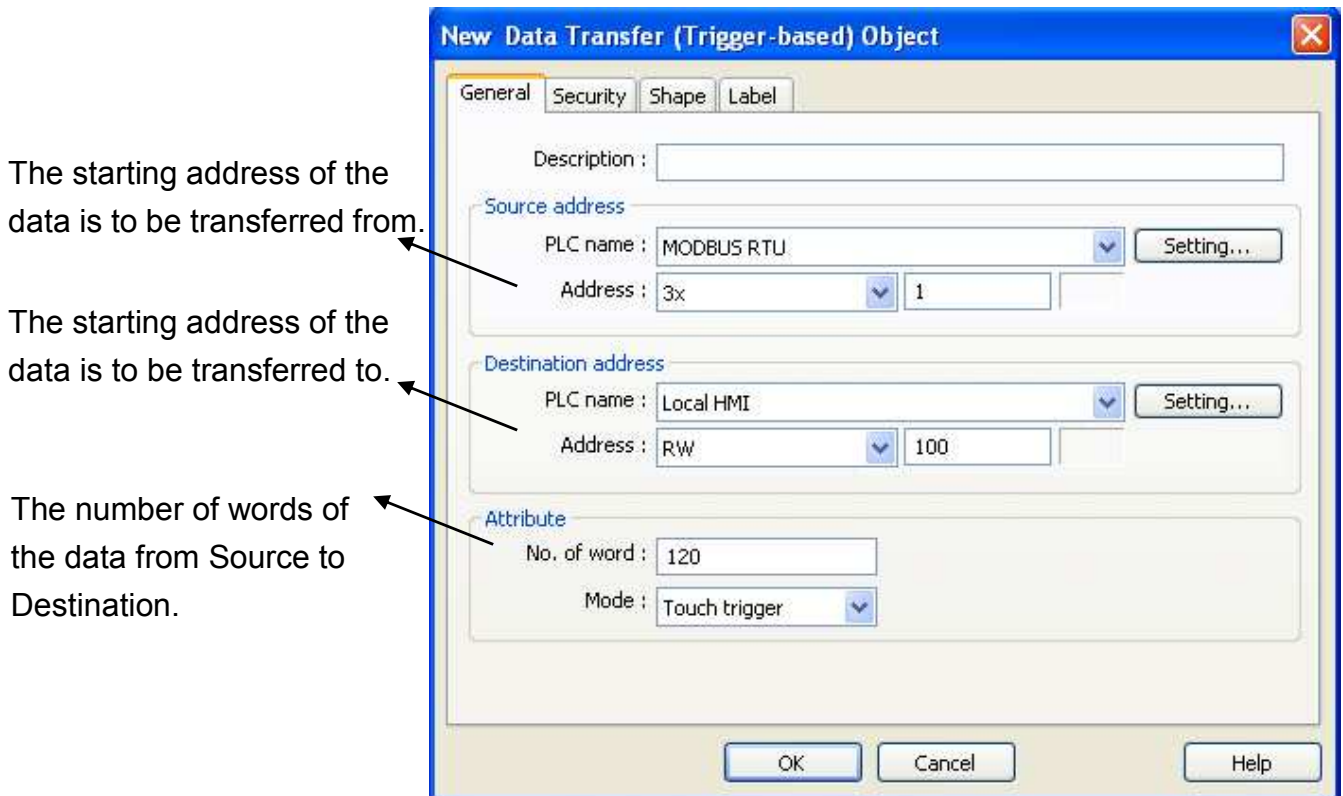

17.4 Saving Recipe Data Automatically

In order to prolong HMI flash memory life span, EasyBuilder Pro will save Recipe Data automatically **every minute** to HMI. To avoid losing data when switching HMI off during the interval between saving operations, system register [LB-9029: Save all recipe data to machine (set ON)] is provided. Sending ON signal to [LB-9029] will make EasyBuilder Pro save Recipe Data once. Sending ON signal to [LB-9028: Reset all recipe data (set ON)], EasyBuilder Pro will clear all Recipe Data and return to "0".

Chapter 18 Macro Reference

Macros provide the additional functionality your application may need. Macros are automated sequences of commands that are executed at run-time. Macros allow you to perform tasks such as complex scaling operations, string handling, and user interactions with your projects. This chapter describes syntax, usage, and programming methods of macro commands.

18.1 Instructions to the Macro Editor

1. Macro editor provides the following new functions:
 - a. displaying line number
 - b. Undo / Redo
 - c. Cut / Copy / Paste
 - d. Select All
 - e. Toggle Bookmark / Previous Bookmark / Next Bookmark / Clear All
Bookmarks
 - f. Toggle All Outlining

The instructions below show you how to use these new functions.

2. Open the macro editor; you'll see the line numbers displayed on the left-hand side of the edit area.

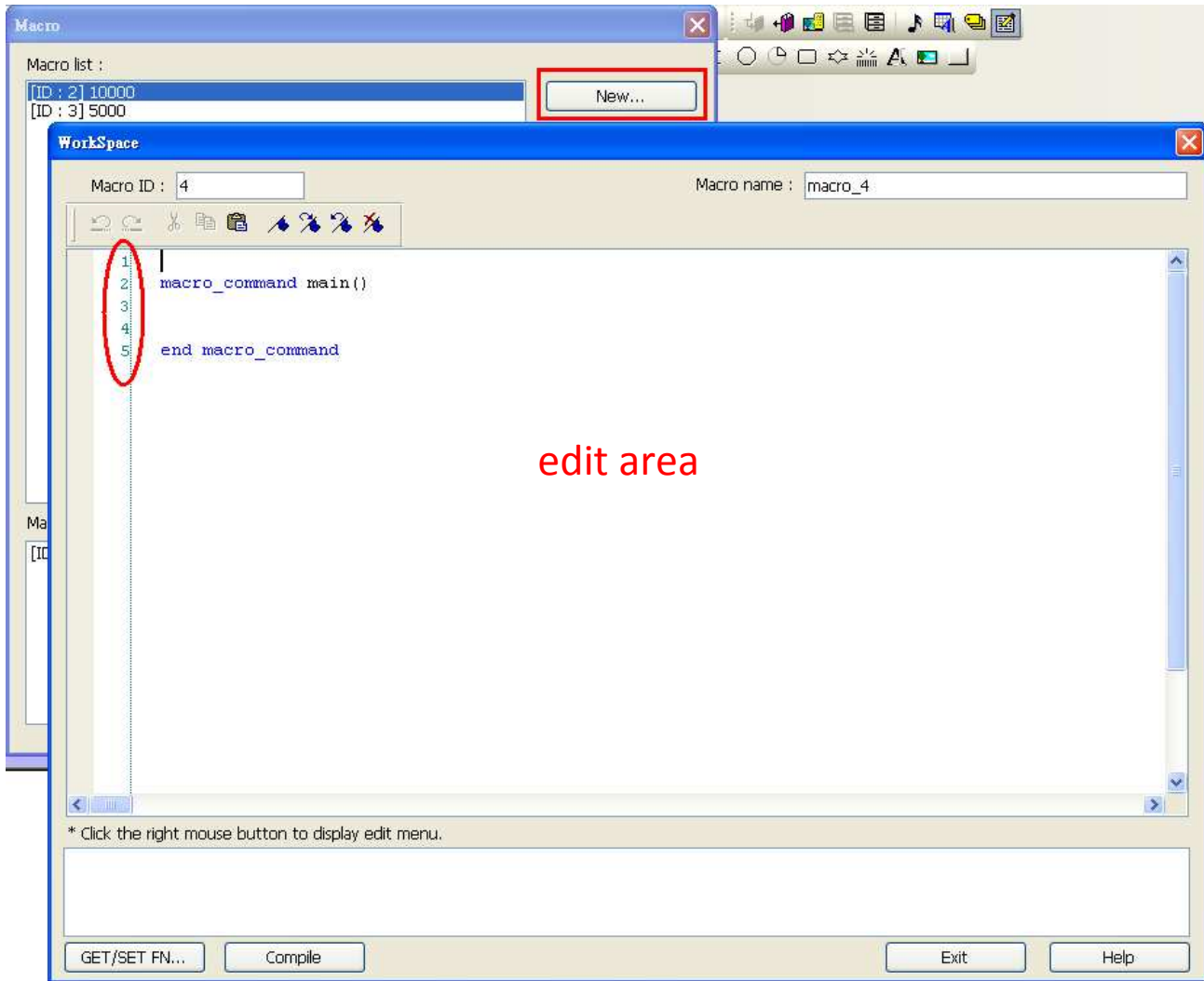

3. Right click on the edit area to open the pop-up menu as shown below:

<u>U</u> ndo	Ctrl+Z
<u>R</u> edo	Ctrl+Y
<u>C</u> ut	Ctrl+X
<u>C</u> opy	Ctrl+C
<u>P</u> aste	Ctrl+V
Select <u>A</u> ll	Ctrl+A
<u>T</u> oggle <u>B</u> ookmark	Ctrl+F2
<u>N</u> ext Bookmark	F2
<u>P</u> revious Bookmark	Shift+F2
Clear All Bookmarks	
<u>T</u> oggle All Outlining	
<u>U</u> ppdate All Outlining	

The disabled items are colored grey, which indicates that it is not possible to use that function in the current status of the editor. For example, you should mark a selected area to enable the copy function, otherwise it will be disabled.

Accelerators are supported as described in the menu.

4. Above the edit area locates the toolbar. It provides “Undo”, “Redo”, “Cut”, “Copy”, “Paste”, “Toggle Bookmark”, “Next Bookmark”, “Previous Bookmark” and “Clear All Bookmarks” buttons for instant use.



5. Modifications made to the editor will enable the undo function. Redo function will be enabled after the undo action is taken. To perform the undo/redo action, right click to select the item or use the accelerator (Undo: Ctrl+Z, Redo: Ctrl+Y).

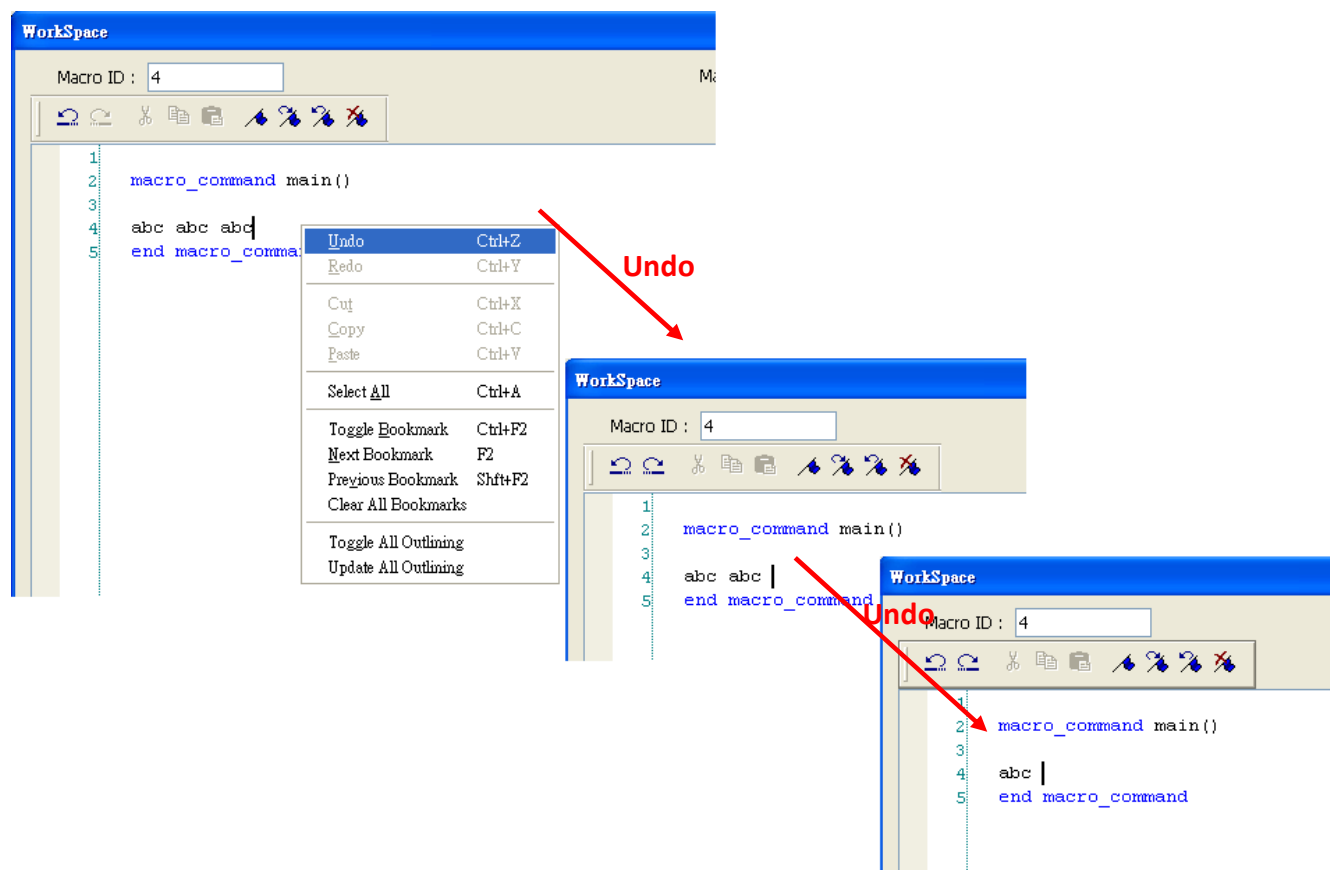

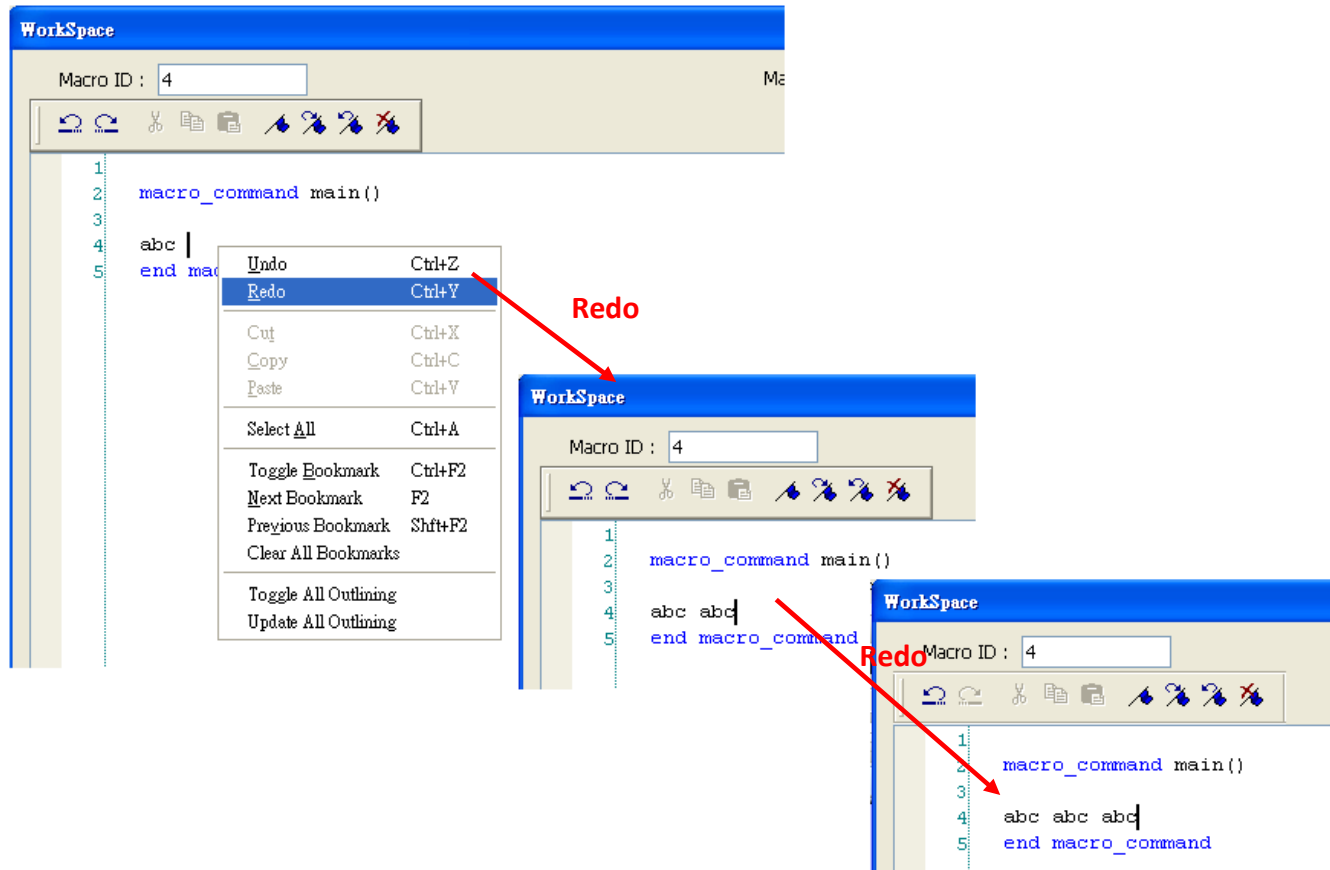

6. Select a word in the editor to enable the cut and copy function. After cut or copy is performed, the paste function is enabled.

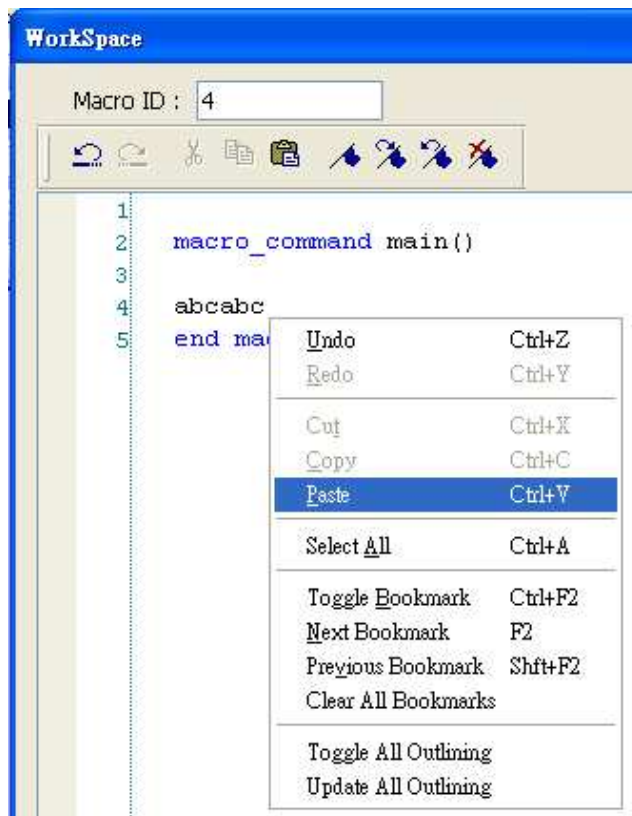
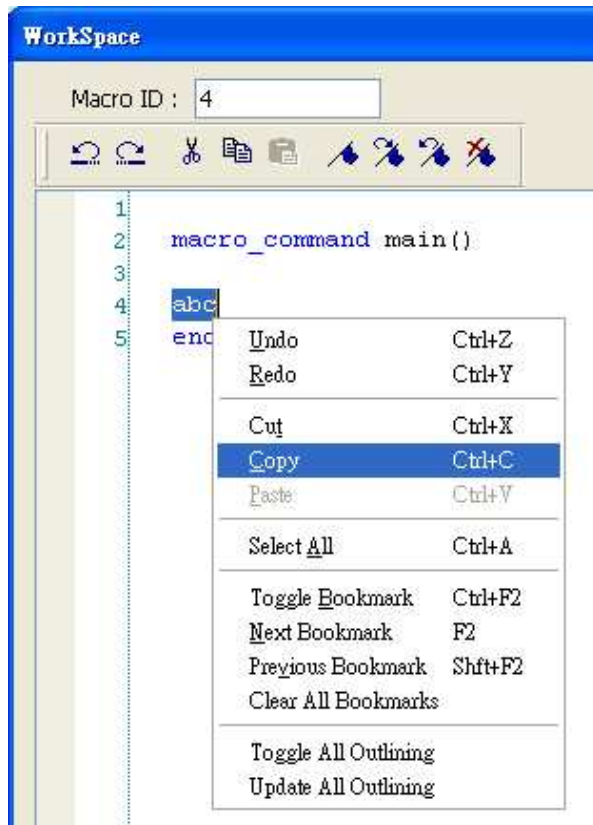

7. Use "Select All" to include all the content in the edit area.

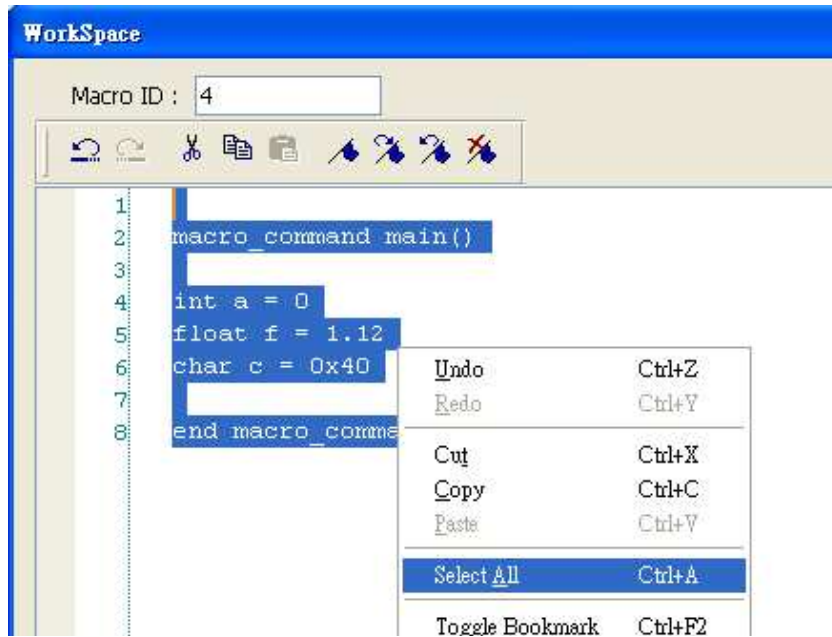

8. If the macro code goes very long, for easier reading, bookmarks are provided.
The illustration below shows how it works.
 - a. Move your cursor to the position in the edit area where to insert a bookmark. Right click, select "Toggle Bookmark". There will be a blue little square that represents a bookmark on the left side of edit area.

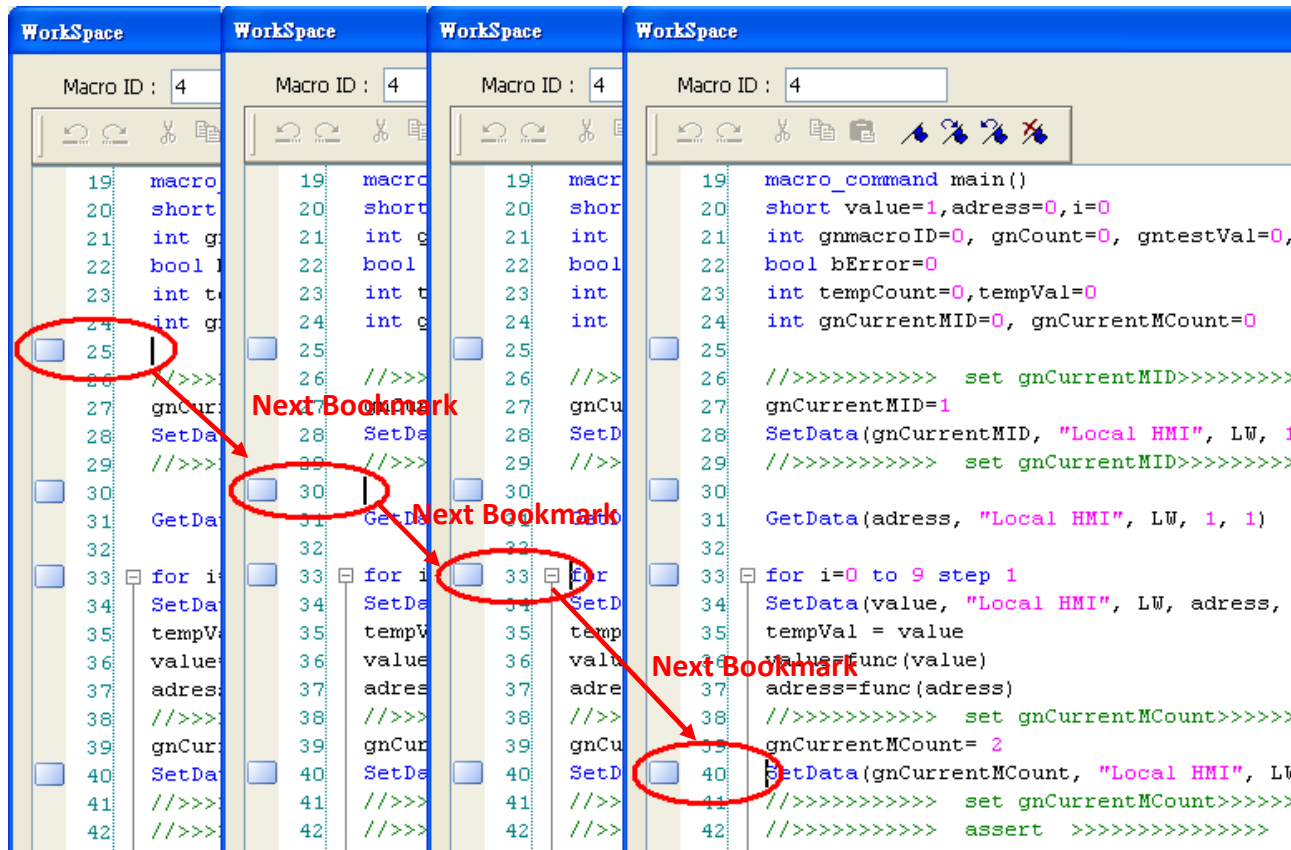

d. Selecting “Clear All Bookmarks” will close all bookmarks.

9. Macro editor provides macro code outlining function, for easier viewing. This function is to hide macro codes that belong to same block, and display them with an icon. There will be a tree diagram on the left side of edit area. Users can click to hide the block or to open as shown below:

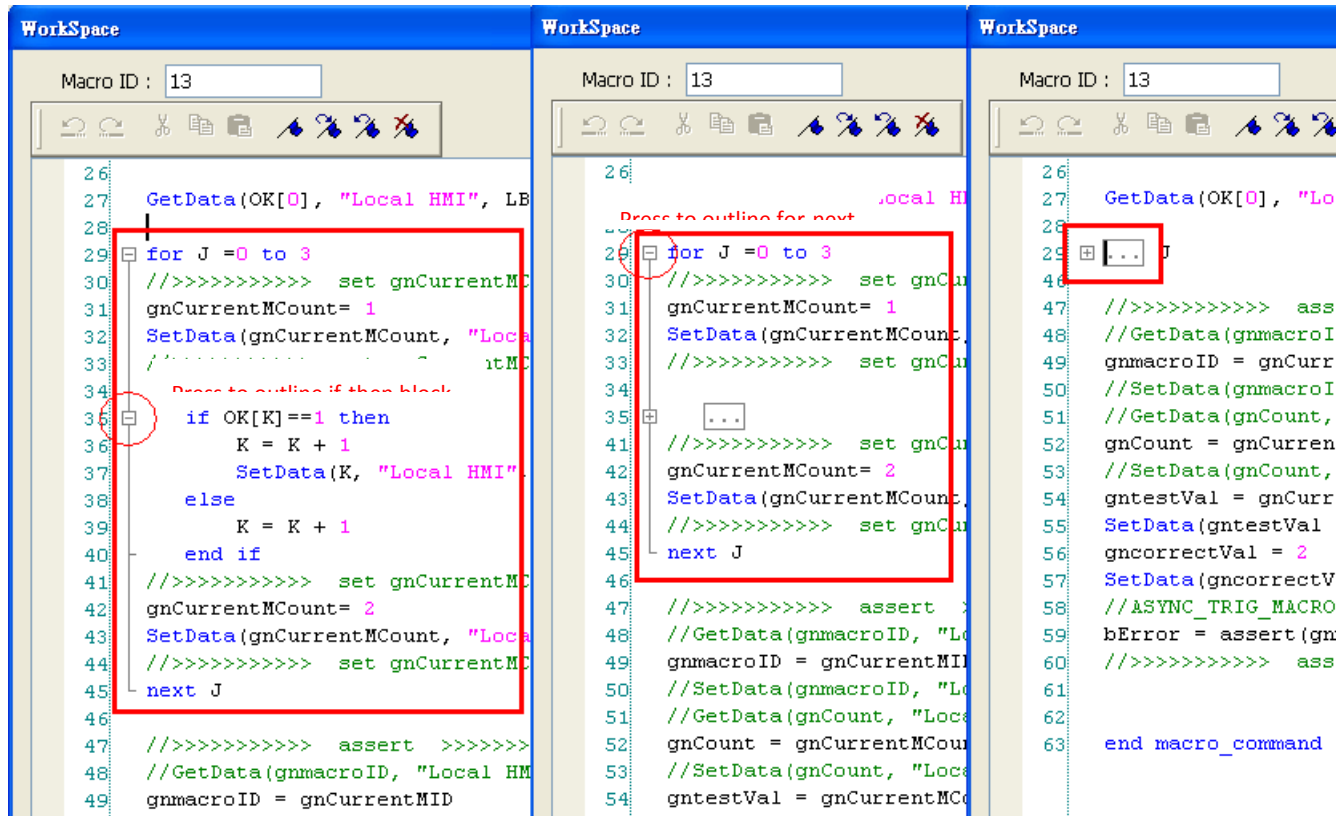

10. Right click to select “Toggle All Outlining” to open all macro code blocks.

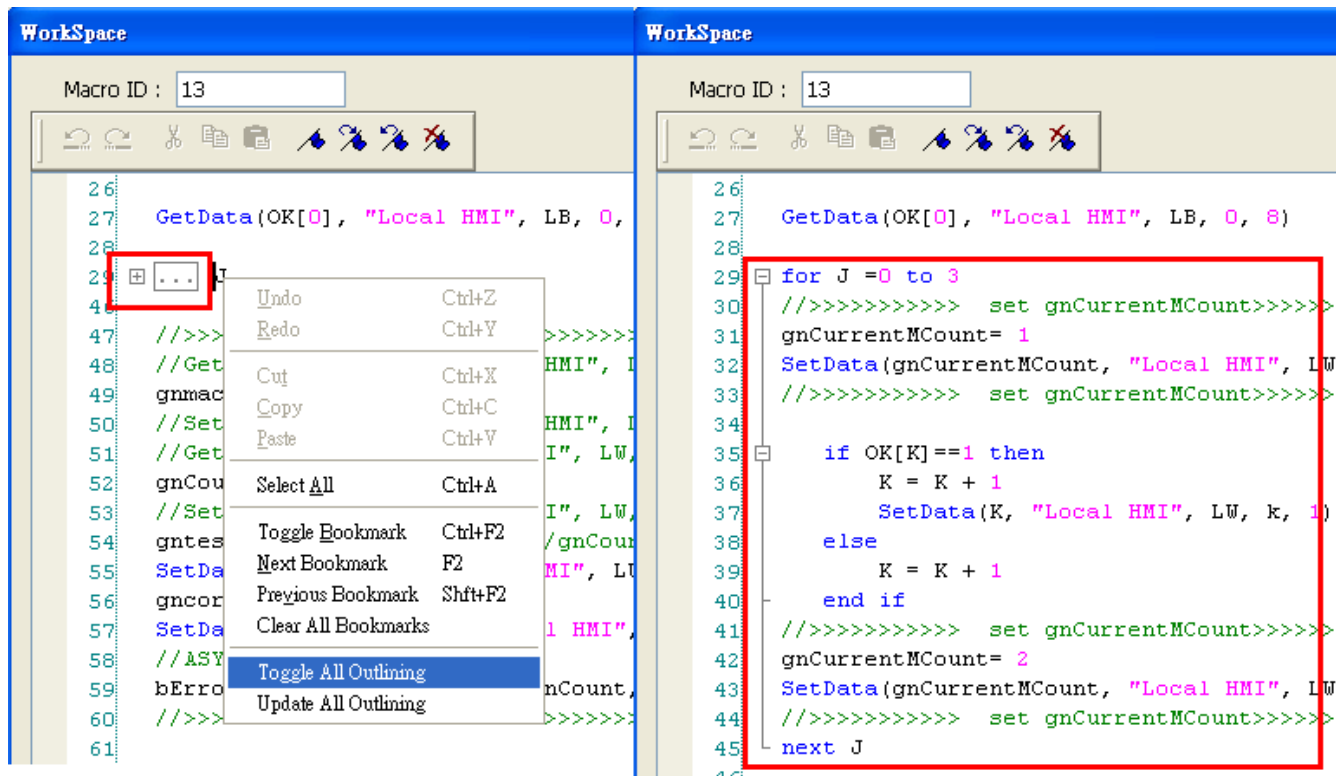

11. Sometimes the outlining might be incorrect since that the keywords are misjudged. For example:

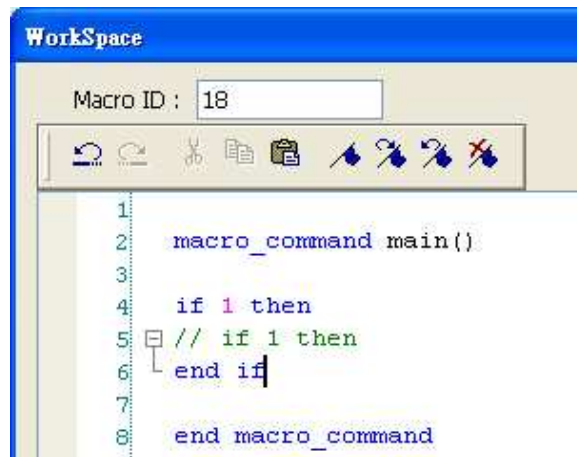

The screenshot shows a 'Workspace' window with 'Macro ID : 18'. The code is as follows:

```
1
2  macro_command main()
3
4  if 1 then
5  // if 1 then
6  end if
7
8  end macro_command
```

The outlining is incorrect, showing a small square icon next to line 5, indicating that the editor has misjudged the structure of the code block.

To solve this problem , right click to select “Update All Outlining” to retrieve correct outlining.

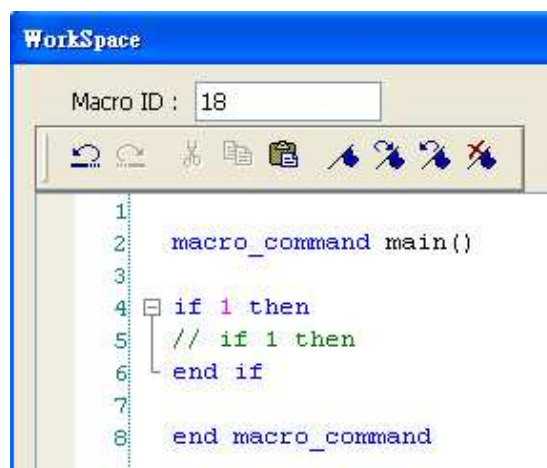

The screenshot shows the same 'Workspace' window with 'Macro ID : 18'. The code is identical to the previous screenshot:

```
1
2  macro_command main()
3
4  if 1 then
5  // if 1 then
6  end if
7
8  end macro_command
```

After clicking 'Update All Outlining', the outlining is now correct, with a small square icon next to line 4, indicating that the editor has correctly identified the start of the 'if' block.

12. The statements enclosed in the following keywords are called a “block” of the macro code:

- a. Function block: sub – end sub
- b. Reiterative statements:
 - i. for – next
 - ii. while – wend
- c. Logical statements:

- i. if – end if
- d. Selective statements: select case – end select

18.2 Macro Construction

A Macro is made up of statements. The statements contain constants, variables and operations. The statements are put in a specific order to create the desired output.

A Macro is constructed in the following fashion:

Global Variable Declaration	-----Optional
Sub Function Block Declarations	-----Optional
Local Variable Declarations	
End Sub	
macro_command main()	-----Required
Local Variable Declarations	
[Statements]	
end macro_command	-----Required

Macro must have one and only one main function which is the execution start point of macro. The format is:

```
macro_command Function_Name()
```

```
end macro_command
```

Local variables are used within the main macro function or in a defined function block. Its value remains valid only within the specific block.

Global variables are declared before any function blocks and are valid for all functions in the macro. When local variables and global variables have the same declaration of name, only the local variables are valid.

The example below is a simple Macro which includes a variable declaration and a function call.

```
macro_command main()
    short pressure = 10                // local variable
declaration
```

```
SetData(pressure, "Allen-Bradley DF1", N7, 0, 1)    // function calling
end macro_command
```

18.3 Syntax

18.3.1 Constants and Variables

18.3.1.1 Constants

Constants are fixed values and can be written directly into statements. The format is as below:

Constant Type	Note	Example
Decimal integer		345, -234, 0, 23456
Hexadecimal	Must begin with 0x	0x3b, 0xffff, 0x237
ASCII	String must be enclosed in single quotes	'a', 'data', 'name'
Boolean		true, false

Example of some statements using constants:

```
macro_command main()
short A, B    // A and B are variables
A = 1234
B = 0x12    // 1234 and 0x12 are constants
end macro_command
```

18.3.1.2 Variables

Variables are names that represent information. The information can be changed as the variable is modified by statements.

Naming Rules for Variables

1. A variable name must start with an alphabet.
2. Variable names longer than 32 characters are not allowed.
3. Reserved words cannot be used as Variable names.

There are 8 different Variable types, 5 for signed data types and 3 for unsigned data types:

Variable Type	Description	Range
bool	1 bit (discrete)	0, 1
Char	8 bits (byte)	±127
short	16 bits (word)	±32767
Int	32 bits (double word)	±2147418112
float	32 bits (double word)	
unsigned char	8 bits (byte)	0 to 255
unsigned short	16 bits (word)	0 to 65535
unsigned int	32 bits (double word)	0 to 4,294,967,295

Declaring Variables

Variables must be declared before being used. To declare a variable, specify the type before the variable name.

Example:

```
int    a
short  b, switch
float  pressure
unsigned short c
```

Declaring Arrays

Macros support one-dimensional arrays (zero-based index). To declare an array of variables, specify the type and the variable name followed by the number of variables in the array enclosed in brackets “[]”. Arrays are 1 to 4096 variables in length. (Macros only support up to 4096 variables per macro).

Example:

```
int    a[10]
short  b[20], switch[30]
float  pressure[15]
```

Minimum of array index is 0 and maximum of array index is (array size – 1).

Example:

```
char data 100] // array size is 100  
where: minimum of array index is 0 and maximum of array index is 99 (  
100 – 1)
```

Variable and Array Initialization

There are two ways variables can be initialized:

1. By statement using the assignment operator (=)

Example:

```
int a
float b[3]
a = 10
b[0] = 1
```

2. During declaration

```
char a = '5', b = 9
```

The declaration of arrays is a special case. The entire array can be initialized during declaration by enclosing comma separated values inside curly brackets “{}”.

Example:

```
float data[4] = {11, 22, 33, 44} // now data[0] is 11, data[1] is 22....
```

18.3.2 Operators

Operations are used to designate how data is to be manipulated. In each statement, the operator on the left is set to the conditions on the right.

Operator	Description	Example
=	Assignment operator	pressure = 10

Arithmetic Operators	Description	Example
+	Addition	A = B + C
-	Subtraction	A = B - C
*	Multiplication	A = B * C
/	Division	A = B / C
%	Modulo division (return remainder)	A = B % 5

Comparison Operators	Description	Example
<	Less than	if A < 10 then B = 5
<=	Less than or equal to	if A <= 10 then B = 5
>	Greater than	if A > 10 then B = 5
>=	Greater than or equal to	if A >= 10 then B = 5
==	Equal to	if A == 10 then B = 5
<>	Not equal to	if A <> 10 then B = 5

Logic Operators	Description	Example
And	Logical AND	if A < 10 and B > 5 then C = 10
Or	Logical OR	if A >= 10 or B > 5 then C = 10
Xor	Logical Exclusive OR	if A xor 256 then B = 5
Not	Logical NOT	if not A then B = 5

Shift and bitwise operators are used to manipulate bits within char, short, and int variable types with both signed and unsigned. The priority of these operators is from left to right within the statement.

Shift Operators	Description	Example
<<	Shifts the bits in a bitset to the left a specified number of positions	A = B << 8
>>	Shifts the bits in a bitset to the right a specified number of positions	A = B >> 8

Bitwise Operators	Description	Example
&	Bitwise AND	A = B & 0xf
	Bitwise OR	A = B C
^	Bitwise XOR	A = B ^ C
~	One's complement	A = ~B

Priority of All Operators

The overall priority of all operations from highest to lowest is as follows:

Operations within parenthesis are carried out first

Arithmetic operations

Shift and Bitwise operations

Comparison operations

Logic operations

Assignment

Reserved Keywords

The following keywords are reserved for Macro use. They cannot be used for variable, array, or function names.

+, -, *, /, %, >=, >, <=, <, <>, ==, and, or, xor, not, <<, >>, =, &, |, ^, ~
exit, macro_command, for, to, down, step, next, return, bool, short, int, char,
float, void, if, then, else, break, continue, set, sub, end, while, wend, true, false
SQRT, CUBERT, LOG, LOG10, SIN, COS, TAN, COT, SEC, CSC, ASIN,
ACOS, ATAN, BIN2BCD, BCD2BIN, DEC2ASCII, FLOAT2ASCII, HEX2ASCII,
ASCII2DEC, ASCII2FLOAT, ASCII2HEX, FILL, RAND, DELAY, SWAPB,
SWAPW, LOBYTE, HIBYTE, LOWORD, HIWORD, GETBIT, SETBITON,
SETBITOFF, INVBIT, ADDSUM, XORSUM, CRC, INPORT, OUTPORT, POW,
GetError, GetData, GetDataEx, SetData, SetDataEx, SetRTS, GetCTS, Beep,
SYNC_TRIG_MACRO, ASYNC_TRIG_MACRO, TRACE,
FindDataSamplingDate, FindDataSamplingIndex, FindEventLogDate,
FindEventLogIndex
StringGet, StringGetEx, StringSet, StringSetEx, StringCopy, StringMid,
StringDecAsc2Bin, StringBin2DecAsc, StringDecAsc2Float,
StringFloat2DecAsc, StringHexAsc2Bin, StringBin2HexAsc, StringLength,
StringCat, StringCompare, StringCompareNoCase, StringFind,
StringReverseFind, StringFindOneOf, StringIncluding, StringExcluding,
StringToUpper, StringToLower, StringToReverse, StringTrimLeft,
StringTrimRight, StringInsert

18.4 Statement

18.4.1 Definition Statement

This covers the declaration of variables and arrays. The formal construction is as follows:

type name where define the type of name

Example:

```
int A //define a variable A as an integer
```

type name[constant] where define the type of array name

Example:

```
int B[10] where define a variable B as a  
one-dimensional array of size 10
```

18.4.2 Assignment Statement

Assignment statements use the assignment operator to move data from the expression on the right side of the operator to the variable on the left side. An expression is the combination of variables, constants and operators to yield a value.

Variable = Expression

Example

```
A = 2 where a variable A is assigned to 2
```

18.4.3 Logical Statements

Logical statements perform actions depending on the condition of a Boolean expression.

The syntax is as follows:

Single-Line Format

```
if <Condition> then
    [Statements]
else
    [Statements]
end if
```

Example:

```
if a == 2 then
    b = 1
else
    b = 2
end if
```

Block Format

```
If <Condition> then
    [Statements]
else if <Condition – n> then
    [Statements]
else
    [Statements]
end if
```

Example:

```
if a == 2 then
    b = 1
else if a == 3 then
    b = 2
else
    b = 3
end if
```

Syntax description:

if	Must be used to begin the statement
<Condition>	Required. This is the controlling statement. It is FALSE when the <Condition> evaluates to 0 and TRUE when it evaluates to non- zero.
then	Must precede the statements to execute if the <Condition> evaluates to TRUE.
[Statements]	It is optional in block format but necessary in single-line format without else. The statement will be executed when the <Condition> is TRUE.
else if	Optional. The else if statement will be executed when the relative <Condition-n> is TRUE.
<Condition-n>	Optional. see <Condition>
else	Optional. The else statement will be executed when <Condition> and <Condition-n> are both FALSE.
end if	Must be used to end an if-then statement.

18.4.4 Selective Statements

The select-case construction can be used to perform selective group of actions depending on the value of the given variable. The actions under the matched case are performed until a break command is read. The syntax is as follows.

Default case free Format

```

Select Case [variable]
Case [value]
    [Statements]
break
end Select
    
```

Example:

```

Select Case A
    Case 1
        b=1
    break
end Select
    
```

Default case Format

```

Select Case [variable]
Case [value]
    
```

```
[Statements]
break
Case else
[Statements]
break

end Select
```

Example:

```
Select Case A
  Case 1
    b=1
  break
  Case else
    b=0
  break
end Select
```

Multiple cases in the same block

```
Select Case [variable]
Case [value1]
  [Statements]
Case [value2]
  [Statements]
  break

end Select
```

Example:

```
Select Case A
  Case 1
  Case 2
    b=2
  Case 3
    b=3
  break
end Select
```

Syntax description:

Select Case	Must be used to begin the statement
[variable]	Required. The value of this variable will be compared to the value of each case.
Case else	Optional. It represents the default case. If none of the cases above are matched, the statements under default case will be executed. When a default case is absent, it will skip directly to the end of the select-case statements if there is no matched case.
break	Optional. The statements under the matched case will be executed until the break command is reached. If a break command is absent, it simply keeps on executing next statement until the end command is reached.
end Select	Indicates the end of the select-case statements

18.4.5 Reiterative Statements

Reiterative statements control loops and repetitive tasks depending on condition. There are two types of reiterative statements.

18.4.5.1 for-next Statements

The for-next construction is for stepping through a fixed number of iterations. A variable is used as a counter to track progress and test for ending conditions. Use this for fixed execution counts. The syntax is as follows:

```
for [Counter] = <StartValue> to <EndValue> [step <StepValue>]
    [Statements]
next [Counter]
```

or

```
for [Counter] = <StartValue> down <EndValue> [step <StepValue>]
    [Statements]
next [Counter]
```

Example:

```
for a = 0 to 10 step 2
```

```

        b = a
    next a
    
```

Syntax description:

for	Must be used to begin the statement
[Counter]	Required. This is the controlling statement. The result of evaluating the variable is used as a test of comparison.
<StartValue>	Required. The initial value of [Counter]
to/down	Required. This determines if the <step> increments or decrements the <Counter>. “to” increments <Counter> by <StepValue>. “down” decrements <Counter> by <StepValue>.
<EndValue>	Required. The test point. If the <Counter> is greater than this value, the macro exits the loop.
step	Optional. Specifies that a <StepValue> other than one is to be used.
[StepValue]	Optional. The increment/decrement step of <Counter>. It can be omitted when the value is 1. If [step <StepValue>] are omitted the step value defaults to 1.
[Statements]	Optional. Statements to execute when the evaluation is TRUE. “for-next” loops may be nested.
next	Required.
[Counter]	Optional. This is used when nesting for-next loops.

18.4.5.2 while-wend Statements

The while-wend construction is for stepping through an unknown number of iterations. A variable is used to test for ending conditions. When the condition is TRUE, the statements are executed repetitively until the condition becomes FALSE. The syntax is as follows.

```

while <Condition>
    [Statements]
wend
    
```

Example:

```

    while a < 10
        a = a + 10
    
```

wend

Syntax description:

while	Must be used to begin the statement
continue	Required. This is the controlling statement. When it is TRUE, the loop begins execution. When it is FALSE, the loop terminates.
return [value]	Statements to execute when the evaluation is TRUE.
wend	Indicates the end of the while-end statements

18.4.5.3 Other Control Commands

break	Used in for-next and while-wend. It skips immediately to the end of the reiterative statement.
continue	Used in for-next and while-wend. It ends the current iteration of a loop and starts the next one.
return	The return command inside the main block can force the macro to stop anywhere. It skips immediately to the end of the main block.

18.5 Function Blocks

Function blocks are useful for reducing repetitive codes. It must be defined before use and supports any variable and statement type. A function block is called by putting its name followed by parameters, in parenthesis, in the Main Macro Function. After the function block is executed, it returns the value to the Main Function where it is used as an assignment or condition. A return type is not necessary in definition of function, which means that a function block is not always necessary to return a value. The parameters can also be absent in definition of function while the function has no need to take any parameters from the Main Function. The syntax is as follows:

Definition of function with return type:

```
sub type <name> [(parameters)]  
    Local variable declarations  
    [Statements]  
    [return [value]]  
end sub
```

Example:

```
sub int Add(int x, int y)  
    int result  
    result = x +y  
    return result  
end sub
```

```
macro_command main()  
    int a = 10, b = 20, sum  
    sum = Add(a, b)  
end macro_command
```

or:

```
sub int Add()  
    int result, x=10, y=20  
    result = x +y  
    return result
```

```
end sub

macro_command main()

    int sum

    sum = Add()

end macro_command
```

Definition of function without return type:

```
sub <name> [(parameters)]
    Local variable declarations
    [Statements]
end sub
```

Example:

```
sub Add(int x, int y)

    int result

    result = x +y

end sub

macro_command main()

    int a = 10, b = 20

    Add(a, b)

end macro_command
```

or:

```
sub Add()

    int result, x=10, y=20

    result = x +y
```

```
end sub
```

```
macro_command main()
```

```
    Add()
```

```
end macro_command
```

Syntax description:

sub	Must be used to begin the function block
type	Optional. This is the data type of value that the function returns. A function block is not always necessary to return a value.
(parameters)	Optional. The parameters hold values that are passed to the function by the Main Macro. The passed parameters must have their type declared in the parameter field and assigned a variable name. For example: sub int MyFunction(int x, int y). x and y would be integers passed to the function by the Main Macro. This function is called by a statement that looks similar to this: ret = MyFunction(456, pressure) where "pressure" must be integer according to the definition of function. Notice that the calling statement can pass hard coded values or variables to the function. After this function is executed, an integer values is return to 'ret'.
Local variable declaration	Variables that are used in the function block must be declared first. This is in addition to passed parameters. In the above example x and y are variables that the function can used. Global variables are also available for use in function block.
[Statements]	Statements to execute
[return [value]]	Optional. Used to return a value to the calling statement. The value can be a constant or a variable. Return also ends function block execution. A function block is not always necessary to return a value, but, when the return type is defined in the beginning of the definition of function, the return command is needed.
end sub	Must be used to end a function block.

18.6 Build-In Function Block

EasyBuilder8000 has some build-in functions for retrieving and transferring data to the PLC, data management and mathematical functions.

18.6.1 Mathematical Functions

Name	SQRT
Syntax	SQRT(source, result)
Description	Calculate the square root of source into result. Source can be a constant or a variable, but result must be a variable. Source must be a nonnegative value.
Example	<pre>macro_command main() float source, result SQRT(15, result) source = 9.0 SQRT(source, result)// result is 3.0 end macro_command</pre>

Name	CUBERT
Syntax	CUBERT (source, result)
Description	Calculate the cube root of source into result. Source can be a constant or a variable, but result must be a variable. Source must be a nonnegative value.
Example	<pre>macro_command main() float source, result CUBERT (27, result) // result is 3.0 source = 27.0 CUBERT(source, result)// result is 3.0 end macro_command</pre>

Name	POW
Syntax	POW (source1, source2, result)
Description	<p>Calculate source1 raised to the power of source2.</p> <p>Source1 and source2 can be a constant or a variable, but result must be a variable.</p> <p>Source1 and source2 must be a nonnegative value.</p>
Example	<pre>macro_command main() float y, result y = 0.5 POW (25, y, result) // result = 5 end macro_command</pre>

Name	SIN
Syntax	SIN(source, result)
Description	<p>Calculate the sine of source into result.</p> <p>Source can be a constant or a variable, but result must be a variable.</p>
Example	<pre>macro_command main() float source, result SIN(90, result)// result is 1 source = 30 SIN(source, result)// result is 0.5 end macro_command</pre>

Name	COS
Syntax	COS(source, result)
Description	<p>Calculate the cosine of source into result.</p> <p>Source can be a constant or a variable, but result must be a variable.</p>
Example	<pre>macro_command main() float source, result</pre>

	<pre> COS(90, result)// result is 0 source = 60 GetData(source, "Local HMI", LW, 0, 1) COS(source, result)// result is 0.5 end macro_command </pre>
--	---

Name	TAN
Syntax	TAN(source, result)
Description	Calculate the tangent of source into result. Source can be a constant or a variable, but result must be a variable.
Example	<pre> macro_command main() float source, result TAN(45, result)// result is 1 source = 60 TAN(source, result)// result is 1.732 end macro_command </pre>

Name	COT
Syntax	COT(source, result)
Description	Calculate the cotangent of source into result. Source can be a constant or a variable, but result must be a variable.
Example	<pre> macro_command main() float source, result COT(45, result)// result is 1 source = 60 COT(source, result)// result is 0.5774 end macro_command </pre>

Name	SEC
Syntax	SEC(source, result)
Description	Calculate the secant of source into result. Source can be a constant or a variable, but result must be a variable.
Example	<pre>macro_command main() float source, result SEC(45, result)// result is 1.414 source = 60 SEC(source, result)// if source is 60, result is 2 end macro_command</pre>

Name	CSC
Syntax	CSC(source, result)
Description	Calculate the cosecant of source into result. Source can be a constant or a variable, but result must be a variable.
Example	<pre>macro_command main() float source, result CSC(45, result)// result is 1.414 source = 30 CSC(source, result)// result is 2 end macro_command</pre>

Name	ASIN
Syntax	ASIN(source, result)
Description	Calculate the hyperbolic sine of source into result. Source can be a constant or a variable, but result must be a variable.
Example	<pre>macro_command main() float source, result</pre>

	<pre> ASIN(0.8660, result)// result is 60 source = 0.5 ASIN(source, result)// result is 30 end macro_command </pre>
--	---

Name	ACOS
Syntax	ACOS(source, result)
Description	Calculate the hyperbolic cosine of source into result. Source can be a constant or a variable, but result must be a variable.
Example	<pre> macro_command main() float source, result ACOS(0.8660, result)// result is 30 source = 0.5 ACOS(source, result)// result is 60 end macro_command </pre>

Name	ATAN
Syntax	ATAN(source, result)
Description	Calculate the hyperbolic tangent of source into result. Source can be a constant or a variable, but result must be a variable.
Example	<pre> macro_command main() float source, result ATAN(1, result)// result is 45 source = 1.732 ATAN(source, result)// result is 60 end macro_command </pre>

Name	LOG
Syntax	LOG (source, result)
Description	Calculates the natural logarithm of a number. Source can be either a variable or a constant. Result must be a variable.
Example	macro_command main() float source = 100, result LOG (source, result)// result is approximately 4.6052 end macro_command

Name	LOG10
Syntax	LOG10 (source, result)
Description	Calculates the base-10 logarithm of a number. Source can be either a variable or a constant. Result must be a variable.
Example	macro_command main() float source = 100, result LOG10 (source, result)// result is 2 end macro_command

Name	RAND
Syntax	RAND(result)
Description	Calculates a random integer saved into result. Result must be a variable.
Example	macro_command main() short result RAND (result)// result is not a fixed value when executes macro every time end macro_command

18.6.2 Data Transformation

Name	BIN2BCD
Syntax	BIN2BCD(source, result)
Description	Transforms a binary-type value (source) into a BCD-type value (result). Source can be a constant or a variable, but result must be a variable.
Example	<pre>macro_command main() short source, result BIN2BCD(1234, result)// result is 0x1234 source = 5678 BIN2BCD(source, result)// result is 0x5678 end macro_command</pre>

Name	BCD2BIN
Syntax	BCD2BIN (source, result)
Description	Transforms a BCD-type value (source) into a binary-type value (result). Source can be a constant or a variable, but result must be a variable.
Example	<pre>macro_command main() short source, result BCD2BIN(0x1234, result)// result is 1234 source = 0x5678 BCD2BIN(source, result)// result is 5678 end macro_command</pre>

Name	DEC2ASCII
Syntax	DEC2ASCII(source, result[start], len)
Description	Transforms a decimal value (source) into ASCII string saved to an array (result).

	<p>len represents the length of the string and the unit of length depends on result's type., i.e. if result's type is "char" (the size is byte), the length of the string is (byte * len). If result's type is "short" (the size is word), the length of the string is (word * len), and so on.</p> <p>The first character is put into result[start], the second character is put into result[start + 1], and the last character is put into result[start + (len - 1)].</p> <p>Source and len can be a constant or a variable, but result must be a variable. Start must be a constant.</p>
Example	<pre>macro_command main() short source char result1[4] short result2[4] source = 5678 DEC2ASCII(source, result1[0], 4) // result1[0] is '5', result1[1] is '6', result1[2] is '7', result1[3] is '8' // the length of the string (result1) is 4 bytes(= 1 * 4) DEC2ASCII(source, result2[0], 4) // result2[0] is '5', result2[1] is '6', result2[2] is '7', result2[3] is '8' // the length of the string (result2) is 8 bytes(= 2 * 4) end macro_command</pre>

Name	HEX2ASCII
Syntax	HEX2ASCII(source, result[start], len)
Description	<p>Transforms a hexadecimal value (source) into ASCII string saved to an array (result).</p> <p>len represents the length of the string and the unit of length depends on result's type., i.e. if result's type is "char" (the size is byte), the length of the string is (byte * len). If result's type is "short" (the size is word), the length of the string is (word * len), and so on.</p> <p>source and len can be a constant or a variable, but result must be a variable. start must be a constant.</p>
Example	<pre>macro_command main() short source char result[4]</pre>

	<pre> source = 0x5678 HEX2ASCII (source, result[0], 4) // result[0] is '5', result[1] is '6', result[2] is '7', result[3] is '8' end macro_command </pre>
--	--

Name	FLOAT2ASCII
Syntax	FLOAT2ASCII (source, result[start], len)
Description	<p>Transforms a floating value (source) into ASCII string saved to an array (result).</p> <p>len represents the length of the string and the unit of length depends on result's type., i.e. if result's type is "char" (the size is byte), the length of the string is (byte * len). If result's type is "short" (the size is word), the length of the string is (word * len), and so on.</p> <p>Source and len can be a constant or a variable, but result must be a variable. Start must be a constant.</p>
Example	<pre> macro_command main() float source char result[4] source = 56.8 FLOAT2ASCII (source, result[0], 4) // result[0] is '5', result[1] is '6', result[2] is '.', result[3] is '8' end macro_command </pre>

Name	ASCII2DEC
Syntax	ASCII2DEC(source[start], result, len)
Description	<p>Transforms a string (source) into a decimal value saved to a variable (result).</p> <p>The length of the string is len. The first character of the string is source[start].</p> <p>Source and len can be a constant or a variable, but result must be a variable. Start must be a constant.</p>
Example	<pre> macro_command main() char source[4] </pre>

	<pre> short result source[0] = '5' source[1] = '6' source[2] = '7' source[3] = '8' ASCII2DEC(source[0], result, 4) // result is 5678 end macro_command </pre>
--	--

Name	ASCII2HEX
Syntax	ASCII2HEX (source[start], result, len)
Description	<p>Transforms a string (source) into a hexadecimal value saved to a variable (result).</p> <p>The length of the string is len. The first character of the string is source[start].</p> <p>Source and len can be a constant or a variable, but result must be a variable. Start must be a constant.</p>
Example	<pre> macro_command main() char source[4] short result source[0] = '5' source[1] = '6' source[2] = '7' source[3] = '8' ASCII2HEX (source[0], result, 4) // result is 0x5678 end macro_command </pre>

Name	ASCII2FLOAT
Syntax	ASCII2FLOAT (source[start], result, len)
Description	Transforms a string (source) into a float value saved to a variable (result).

	<p>The length of the string is len. The first character of the string is source[start].</p> <p>Source and len can be a constant or a variable, but result must be a variable. Start must be a constant.</p>
Example	<pre>macro_command main() char source[4] float result source[0] = '5' source[1] = '6' source[2] = '.' source[3] = '8' ASCII2FLOAT (source[0], result, 4) // result is 56.8 end macro_command</pre>

18.6.3 Data Manipulation

Name	FILL
Syntax	FILL(source[start], preset, count)
Description	Sets the first count elements of an array (source) to a specified value (preset). source and start must be a variable, and preset can be a constant or variable.
Example	<pre>macro_command main() char result[4] char preset FILL(result[0], 0x30, 4) // result[0] is 0x30, result[1] is 0x30, , result[2] is 0x30, , result[3] is 0x30 preset = 0x31 FILL(result[0], preset, 2) // result[0] is 0x31, result[1] is 0x31 end macro_command</pre>

Name	SWAPB
Syntax	SWAPB(source, result)
Description	Exchanges the high-byte and low-byte data of a 16-bit source into result. Source can be a constant or a variable, but result must be a variable.
Example	<pre>macro_command main() short source, result SWAPB(0x5678, result)// result is 0x7856 source = 0x123 SWAPB(source, result)// result is 0x2301 end macro_command</pre>

Name	SWAPW
Syntax	SWAPW(source, result)

Description	Exchanges the high-word and low-word data of a 32-bit source into result. Source can be a constant or a variable, but result must be a variable.
Example	<pre>macro_command main() int source, result SWAPW (0x12345678, result)// result is 0x56781234 source = 0x12345 SWAPW (source, result)// result is 0x23450001 end macro_command</pre>

Name	LOBYTE
Syntax	LOBYTE(source, result)
Description	Retrieves the low byte of a 16-bit source into result. Source can be a constant or a variable, but result must be a variable.
Example	<pre>macro_command main() short source, result LOBYTE(0x1234, result)// result is 0x34 source = 0x123 LOBYTE(source, result)// result is 0x23 end macro_command</pre>

Name	HIBYTE
Syntax	HIBYTE(source, result)
Description	Retrieves the high byte of a 16-bit source into result. Source can be a constant or a variable, but result must be a variable.
Example	<pre>macro_command main() short source, result HIBYTE(0x1234, result)// result is 0x12 source = 0x123</pre>

	<pre>HIBYTE(source, result)// result is 0x01 end macro_command</pre>
--	--

Name	LOWORD
Syntax	LOWORD(source, result)
Description	Retrieves the low word of a 32-bit source into result. Source can be a constant or a variable, but result must be a variable.
Example	<pre>macro_command main() int source, result LOWORD(0x12345678, result)// result is 0x5678 source = 0x12345 LOWORD(source, result)// result is 0x2345 end macro_command</pre>

Name	HIWORD
Syntax	HIWORD(source, result)
Description	Retrieves the high word of a 32-bit source into result. Source can be a constant or a variable, but result must be a variable.
Example	<pre>macro_command main() int source, result HIWORD(0x12345678, result)// result is 0x1234 source = 0x12345 HIWORD(source, result)// result is 0x0001 end macro_command</pre>

18.6.4 Bit Transformation

Name	GETBIT
Syntax	GETBIT(source, result, bit_pos)
Description	Gets the state of designated bit position of a data (source) into result. Result's value will be 0 or 1. Source and bit_pos can be a constant or a variable, but result must be a variable.
Example	<pre>macro_command main() int source, result short bit_pos GETBIT(9, result, 3)// result is 1 source = 4 bit_pos = 2 GETBIT(source, result, bit_pos)// result is 1 end macro_command</pre>

Name	SETBITON
Syntax	SETBITON(source, result, bit_pos)
Description	Changes the state of designated bit position of a data (source) to 1, and put changed data into result. Source and bit_pos can be a constant or a variable, but result must be a variable.
Example	<pre>macro_command main() int source, result short bit_pos SETBITON(1, result, 3)// result is 9 source = 0 bit_pos = 2 SETBITON (source, result, bit_pos)// result is 4 end macro_command</pre>

Name	SETBITOFF
Syntax	SETBITOFF(source, result, bit_pos)
Description	Changes the state of designated bit position of a data (source) to 0, and put in changed data into result. Source and bit_pos can be a constant or a variable, but result must be a variable.
Example	<pre>macro_command main() int source, result short bit_pos SETBITOFF(9, result, 3)// result is 1 source = 4 bit_pos = 2 SETBITOFF(source, result, bit_pos)// result is 0 end macro_command</pre>

Name	INVBIT
Syntax	INVBIT(source, result, bit_pos)
Description	Inverts the state of designated bit position of a data (source), and put changed data into result. Source and bit_pos can be a constant or a variable, but result must be a variable.
Example	<pre>macro_command main() int source, result short bit_pos INVBIT(4, result, 1)// result = 6 source = 6 bit_pos = 1 INVBIT(source, result, bit_pos)// result = 4 end macro_command</pre>

18.6.5 Communication

Name	DELAY
Syntax	DELAY(time)
Description	Suspends the execution of the current macro for at least the specified interval (time). The unit of time is millisecond. Time can be a constant or a variable.
Example	<pre>macro_command main() int time == 500 DELAY(100)// delay 100 ms DELAY(time)// delay 500 ms end macro_command</pre>

Name	ADDSUM
Syntax	ADDSUM(source[start], result, data_count)
Description	Adds up the elements of an array (source) from source[start] to source[start + data_count - 1] to generate a checksum. Puts in the checksum into result. Result must be a variable. Data_count is the amount of the accumulated elements and can be a constant or a variable.
Example	<pre>macro_command main() char data[5] short checksum data[0] = 0x1 data[1] = 0x2 data[2] = 0x3 data[3] = 0x4 data[4] = 0x5 ADDSUM(data[0], checksum, 5)// checksum is 0xf end macro_command</pre>

Name	XORSUM
Syntax	XORSUM(source[start], result, data_count)
Description	<p>Uses an exclusion method to calculate the checksum from source[start] to source[start + data_count - 1].</p> <p>Puts the checksum into result. Result must be a variable.</p> <p>Data_count is the amount of the calculated elements of the array and can be a constant or a variable.</p>
Example	<pre>macro_command main() char data[5] = {0x1, 0x2, 0x3, 0x4, 0x5} short checksum XORSUM(data[0], checksum, 5)// checksum is 0x1 end macro_command</pre>

Name	CRC
Syntax	CRC(source[start], result, data_count)
Description	<p>Calculates 16-bit CRC of the variables from source[start] to source[start + count - 1].</p> <p>Puts in the 16-bit CRC into result. Result must be a variable.</p> <p>Data_count is the amount of the calculated elements of the array and can be a constant or a variable.</p>
Example	<pre>macro_command main() char data[5] = {0x1, 0x2, 0x3, 0x4, 0x5} short 16bit_CRC CRC(data[0], 16bit_CRC, 5)// 16bit_CRC is 0xbb2a end macro_command</pre>

Name	OUTPORT
Syntax	OUTPORT(source[start], device_name, data_count)
Description	<p>Sends out the specified data from source[start] to source[start + count - 1] to PLC via a COM port or the ethernet.</p> <p>Device_name is the name of a device defined in the device table and the</p>

device must be a “Free Protocol”-type device.

Data_count is the amount of sent data and can be a constant or a variable.

Example

To use an OUTPORT function, a “Free Protocol” device must be created first as follows:

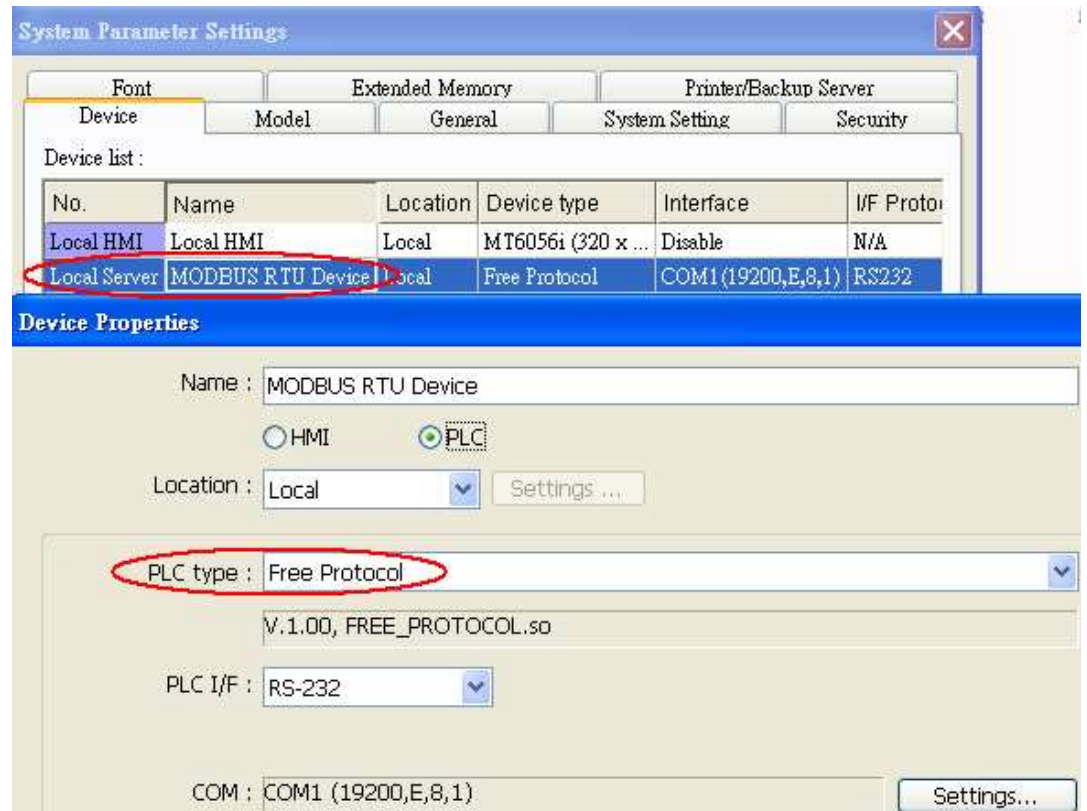

The device is named “MODBUS RTU Device”. The port attribute depends on the setting of this device. (the current setting is “19200,E, 8, 1”)

Below is an example of executing an action of writing single coil (SET ON) to a MODBUS device.

```
macro_command main()
```

```
char command[32]
```

```
short address, checksum
```

```
FILL(command[0], 0, 32)// command initialization
```

```
command[0] = 0x1// station no
```

```
command[1] = 0x5// function code : Write Single Coil
```

	<pre> address = 0 HIBYTE(address, command[2]) LOBYTE(address, command[3]) command[4] = 0xff// force bit on command[5] = 0 CRC(command[0], checksum, 6) LOBYTE(checksum, command[6]) HIBYTE(checksum, command[7]) // send out a "Write Single Coil" command OUTPORT(command[0], "MODBUS RTU Device", 8) end macro_command </pre>
--	---

Name	INPORT
Syntax	INPORT(read_data[start], device_name, read_count, return_value)
Description	<p>Reads data from a COM port or the ethernet. These data is stored to read_data[start]~ read_data[start + read_count - 1].</p> <p>device_name is the name of a device defined in the device table and the device must be a "Free Protocol"-type device.</p> <p>read_count is the required amount of reading and can be a constant or a variable.</p> <p>If the function is used successfully to get sufficient data, return_value is 1, otherwise is 0.</p>
Example	<p>Below is an example of executing an action of reading holding registers of a MODBUS device.</p> <pre> // Read Holding Registers macro_command main() char command[32], response[32] short address, checksum short read_no, return_value, read_data[2] </pre>

```

FILL(command[0], 0, 32)//  command initialization
FILL(response[0], 0, 32)

command[0] = 0x1//  station no
command[1] = 0x3//  function code : Read Holding Registers

address = 0
HIBYTE(address, command[2])
LOBYTE(address, command[3])

read_no = 2//  read 2 words (4x_1 and 4x_2)
HIBYTE(read_no, command[4])
LOBYTE(read_no, command[5])

CRC(command[0], checksum, 6)

LOBYTE(checksum, command[6])
HIBYTE(checksum, command[7])

//  send out a 'Read Holding Registers' command
OUTPORT(command[0], "MODBUS RTU Device", 8)

//  read responses for a 'Read Holding Registers' command
INPORT(response[0], "MODBUS RTU Device", 9, return_value)

if return_value > 0 then
    read_data[0] = response[4] + (response[3] << 8)//  data in 4x_1
    read_data[1] = response[6] + (response[5] << 8)//  data in 4x_2

    SetData(read_data[0], "Local HMI", LW, 100, 2)
end if

end macro_command
    
```

Name	GetData
Syntax	GetData(read_data[start], device_name, device_type, address_offset, data_count)

	or GetData(read_data, device_name, device_type, address_offset, 1)
Description	<p>Receives data from the PLC. Data is stored into read_data[start]~read_data[start + data_count - 1].</p> <p>Data_count is the amount of received data. In general, read_data is an array, but if data_count is 1, read_data can be an array or an ordinary variable. Below are two methods to read one word data from PLC.</p> <pre> macro_command main() short read_data_1[2], read_data_2 GetData(read_data_1[0], "FATEK KB Series", RT, 5, 1) GetData(read_data_2, "FATEK KB Series", RT, 5, 1) end macro_command </pre> <p>Device_name is the PLC name enclosed in the double quotation marks (") and this name has been defined in the device list of system parameters as follows (see FATEK KB Series):</p>  <p>Device_type is the device type and encoding method (binary or BCD) of the PLC data. For example, if device_type is LW_BIN, it means the register is LW and the encoding method is binary. If use BIN encoding method, "_BIN" can be ignored.</p> <p>If device_type is LW_BCD, it means the register is LW and the encoding method is BCD.</p> <p>Address_offset is the address offset in the PLC.</p> <p>For example, GetData(read_data_1[0], "FATEK KB Series", RT, 5, 1)</p>

represents that the address offset is 5.

If address_offset uses the format – “N#AAAAA”, N indicates that PLC’s station number is N. AAAAA represents the address offset. This format is used while multiple PLCs or controllers are connected to a single serial port. For example, GetData(read_data_1[0], “FATEK KB Series”, RT, 2#5, 1) represents that the PLC’s station number is 2. If GetData() uses the default station number defined in the device list as follows, it is not necessary to define station number in address_offset.

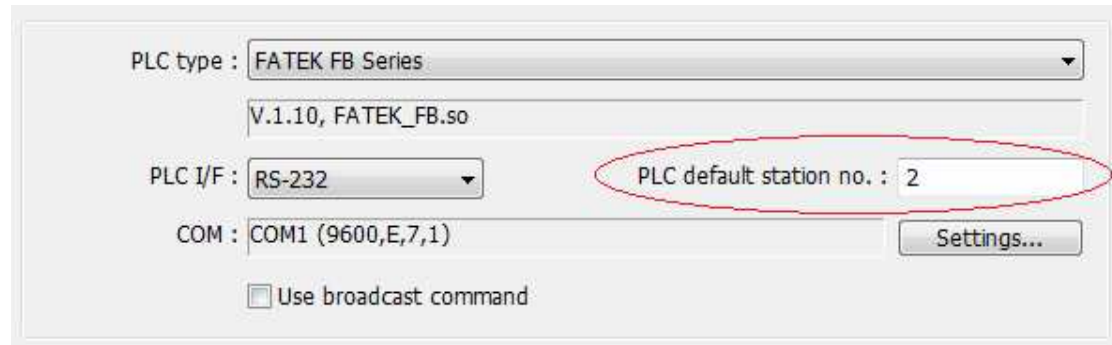

The number of registers actually read from depends on both the type of the read_data variable and the value of the number of data_count.

type of read_data	data_count	actual number of 16-bit register read
char (8-bit)	1	1
char (8-bit)	2	1
bool (8-bit)	1	1
bool (8-bit)	2	1
short (16-bit)	1	1
short (16-bit)	2	2
int (32-bit)	1	2
int (32-bit)	2	4
float (32-bit)	1	2
float (32-bit)	2	4

	<p>When a GetData() is executed using a 32-bit data type (int or float), the function will automatically convert the data. For example,</p> <pre>macro_command main() float f GetData(f, "MODBUS", 6x, 2, 1) // f will contain a floating point value end macro_command</pre>
Example	<pre>macro_command main() bool a bool b[30] short c short d[50] int e int f[10] double g[10] // get the state of LB2 to the variable a GetData(a, "Local HMI", LB, 2, 1) // get 30 states of LB0 ~ LB29 to the variables b[0] ~ b[29] GetData(b[0], "Local HMI", LB, 0, 30) // get one word from LW2 to the variable c GetData(c, "Local HMI", LW, 2, 1) // get 50 words from LW0 ~ LW49 to the variables d[0] ~ d[49] GetData(d[0], "Local HMI", LW, 0, 50) // get 2 words from LW6 ~ LW7 to the variable e // note that the type of e is int GetData(e, "Local HMI", LW, 6, 1) // get 20 words (10 integer values) from LW0 ~ LW19 to variables f[0] ~ f[9] // since each integer value occupies 2 words GetData(f[0], "Local HMI", LW, 0, 10) // get 2 words from LW2 ~ LW3 to the variable f GetData(f, "Local HMI", LW, 2, 1)</pre>

	end macro_command
--	-------------------

Name	GetDataEx
Syntax	GetDataEx (read_data[start], device_name, device_type, address_offset, data_count) or GetDataEx (read_data, device_name, device_type, address_offset, 1)
Description	Receives data from the PLC and continue executing next command even if no response from this device. Descriptions of read_data, device_name, device_type, address_offset and data_count are the same as GetData.
Example	<pre> macro_command main() bool a bool b[30] short c short d[50] int e int f[10] double g[10] // get the state of LB2 to the variable a GetDataEx (a, "Local HMI", LB, 2, 1) // get 30 states of LB0 ~ LB29 to the variables b[0] ~ b[29] GetDataEx (b[0], "Local HMI", LB, 0, 30) // get one word from LW2 to the variable c GetDataEx (c, "Local HMI", LW, 2, 1) // get 50 words from LW0 ~ LW49 to the variables d[0] ~ d[49] GetDataEx (d[0], "Local HMI", LW, 0, 50) // get 2 words from LW6 ~ LW7 to the variable e // note that he type of e is int GetDataEx (e, "Local HMI", LW, 6, 1) </pre>

	<pre>// get 20 words (10 integer values) from LW0 ~ LW19 to f[0] ~ f[9] // since each integer value occupies 2 words GetDataEx (f[0], "Local HMI", LW, 0, 10) // get 2 words from LW2 ~ LW3 to the variable f GetDataEx (f, "Local HMI", LW, 2, 1) end macro_command</pre>
--	--

Name	SetData
Syntax	<pre>SetData(send_data[start], device_name, device_type, address_offset, data_count) or SetData(send_data, device_name, device_type, address_offset, 1)</pre>
Description	<p>Send data to the PLC. Data is defined in send_data[start]~ send_data[start + data_count - 1].</p> <p>data_count is the amount of sent data. In general, send_data is an array, but if data_count is 1, send_data can be an array or an ordinary variable. Below are two methods to send one word data.</p> <pre>macro_command main() short send_data_1[2] = { 5, 6}, send_data_2 = 5 SetData(send_data_1[0], "FATEK KB Series", RT, 5, 1) SetData(send_data_2, "FATEK KB Series", RT, 5, 1) end macro_command</pre> <p>device_name is the PLC name enclosed in the double quotation marks (") and this name has been defined in the device list of system parameters.</p> <p>device_type is the device type and encoding method (binary or BCD) of the PLC data. For example, if device_type is LW_BIN, it means the register is LW and the encoding method is binary. If use BIN encoding method, "_BIN" can be ignored.</p> <p>If device_type is LW_BCD, it means the register is LW and the encoding method is BCD.</p>

address_offset is the address offset in the PLC.

For example, SetData(read_data_1[0], "FATEK KB Series", RT, 5, 1) represents that the address offset is 5.

If address_offset uses the format – "N#AAAAA", N indicates that PLC's station number is N. AAAAA represents the address offset. This format is used while multiple PLCs or controllers are connected to a single serial port. For example, SetData(read_data_1[0], "FATEK KB Series", RT, 2#5, 1) represents that the PLC's station number is 2. If SetData () uses the default station number defined in the device list, it is not necessary to define station number in address_offset.

The number of registers actually sends to depends on both the type of the send_data variable and the value of the number of data_count.

type of read_data	data_count	actual number of 16-bit register send
char (8-bit)	1	1
char (8-bit)	2	1
bool (8-bit)	1	1
bool (8-bit)	2	1
short (16-bit)	1	1
short (16-bit)	2	2
int (32-bit)	1	2
int (32-bit)	2	4
float (32-bit)	1	2
float (32-bit)	2	4

When a SetData() is executed using a 32-bit data type (int or float), the function will automatically send int-format or float-format data to the device. For example,

```
macro_command main()
```

```
float f = 2.6
```

	<pre> SetData(f, "MODBUS", 6x, 2, 1) // will send a floating point value to the device end macro_command </pre>
Example	<pre> macro_command main() int i bool a = true bool b[30] short c = false short d[50] int e = 5 int f[10] for i = 0 to 29 b[i] = true next i for i = 0 to 49 d[i] = i * 2 next i for i = 0 to 9 f [i] = i * 3 next i // set the state of LB2 SetData(a, "Local HMI", LB, 2, 1) // set the states of LB0 ~ LB29 SetData(b[0], "Local HMI", LB, 0, 30) // set the value of LW2 SetData(c, "Local HMI", LW, 2, 1) // set the values of LW0 ~ LW49 SetData(d[0], "Local HMI", LW, 0, 50) // set the values of LW6 ~ LW7, note that the type of e is int SetData(e, "Local HMI", LW, 6, 1) </pre>

	<pre>// set the values of LW0 ~ LW19 // 10 integers equal to 20 words, since each integer value occupies 2 words. SetData(f[0], "Local HMI", LW, 0, 10) end macro_command</pre>
--	--

Name	SetDataEx
Syntax	SetDataEx (send_data[start], device_name, device_type, address_offset, data_count) or SetDataEx (send_data, device_name, device_type, address_offset, 1)
Description	Send data to the PLC and continue executing next command even if no response from this device. Descriptions of send_data, device_name, device_type, address_offset and data_count are the same as SetData.
Example	<pre>macro_command main() int i bool a = true bool b[30] short c = false short d[50] int e = 5 int f[10] for i = 0 to 29 b[i] = true next i for i = 0 to 49 d[i] = i * 2 next i for i = 0 to 9 f [i] = i * 3</pre>

	<pre> next i // set the state of LB2 SetDataEx (a, "Local HMI", LB, 2, 1) // set the states of LB0 ~ LB29 SetDataEx (b[0], "Local HMI", LB, 0, 30) // set the value of LW2 SetDataEx (c, "Local HMI", LW, 2, 1) // set the values of LW0 ~ LW49 SetDataEx (d[0], "Local HMI", LW, 0, 50) // set the values of LW6 ~ LW7, note that the type of e is int SetDataEx (e, "Local HMI", LW, 6, 1) // set the values of LW0 ~ LW19 // 10 integers equal to 20 words, since each integer value occupies 2 words. SetDataEx (f[0], "Local HMI", LW, 0, 10) end macro_command </pre>
--	--

Name	GetError
Syntax	GetError (err)
Description	Get an error code.
Example	<pre> macro_command main() short err char byData[10] GetDataEx(byData[0], "MODBUS RTU", 4x, 1, 10)// read 10 bytes // if err is equal to 0, it is successful to execute GetDataEx() GetErr(err)// save an error code to err </pre>

	end macro_command
--	-------------------

Name	PURGE
Syntax	PURGE (com_port)
Description	<p>com_port refers to the COM port number which ranges from 1 to 3. It can be either a variable or a constant.</p> <p>This function is used to clear the input and output buffers associated with the COM port.</p>
Example	<pre>macro_command main() int com_port=3 PURGE (com_port) PURGE (1) end macro_command</pre>

Name	SetRTS
Syntax	SetRTS(com_port, source)
Description	<p>Set RTS state for RS232.</p> <p>com_port refers to the COM port number 1 . It can be either a variable or a constant. Source also can be either a variable or a constant.</p> <p>This command raise RTS signal while the value of source is greater than 0 and lower RTS signal while the value of source equals to 0.</p>
Example	<pre>macro_command main() char com_port=1 char value=1 SetRTS(com_port, value) // raise RTS signal of COM1 while value>0 SetRTS(1, 0) // lower RTS signal of COM1 end macro_command</pre>

Name	GetCTS
Syntax	GetCTS(com_port, result)
Description	<p>Get CTS state for RS232.</p> <p>com_port refers to the COM port number 1. It can be either a variable or a constant. Result is used for receiving the CTS signal. It must be a variable. This command receives CTS signal and stores the received data in the result variable. When the CTS signal is pulled high, it writes 1 to result, otherwise, it writes 0.</p>
Example	<pre>macro_command main() char com_port=1 char result GetCTS(com_port, result) // get CTS signal of COM1 GetCTS (1, result) // get CTS signal of COM1 end macro_command</pre>

Name	Beep
Syntax	Beep ()
Description	<p>Plays beep sound.</p> <p>This command plays a beep sound with frequency of 800 hertz and duration of 30 milliseconds.</p>
Example	<pre>macro_command main() Beep() end macro_command</pre>

18.6.6 String Operation Functions

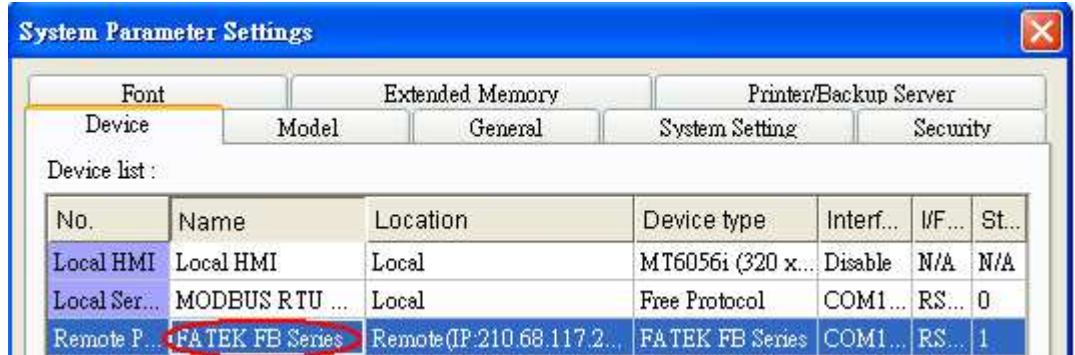
Name	StringGet																												
Syntax	StringGet(read_data[start], device_name, device_type, address_offset, data_count)																												
Description	<p>Receives data from the PLC. The String data is stored into read_data[start]~read_data[start + data_count - 1]. read_data must be a one-dimensional char array.</p> <p>Data_count is the number of received characters, it can be either a constant or a variable.</p> <p>Device_name is the PLC name enclosed in the double quotation marks (“”) and this name has been defined in the device list of system parameters as follows (see FATEK KB Series):</p> <div data-bbox="454 831 1533 1184" data-label="Image">  <table border="1"> <thead> <tr> <th>No.</th> <th>Name</th> <th>Location</th> <th>Device type</th> <th>Interf...</th> <th>WF...</th> <th>St...</th> </tr> </thead> <tbody> <tr> <td>Local HMI</td> <td>Local HMI</td> <td>Local</td> <td>MT6056i (320 x...</td> <td>Disable</td> <td>N/A</td> <td>N/A</td> </tr> <tr> <td>Local Ser...</td> <td>MODBUS RTU ...</td> <td>Local</td> <td>Free Protocol</td> <td>COM1...</td> <td>RS...</td> <td>0</td> </tr> <tr> <td>Remote P...</td> <td>FATEK FB Series</td> <td>Remote (IP:210.68.117.2...</td> <td>FATEK FB Series</td> <td>COM1...</td> <td>RS...</td> <td>1</td> </tr> </tbody> </table> </div> <p>Device_type is the device type and encoding method (binary or BCD) of the PLC data. For example, if device_type is LW_BIN, it means the register is LW and the encoding method is binary. If use BIN encoding method, “_BIN” can be ignored.</p> <p>If device_type is LW_BCD, it means the register is LW and the encoding method is BCD.</p> <p>Address_offset is the address offset in the PLC. For example, StringGet(read_data_1[0], “FATEK KB Series”, RT, 5, 1) represents that the address offset is 5.</p> <p>If address_offset uses the format – “N#AAAAA”, N indicates that PLC’s station number is N. AAAAA represents the address offset. This format is used while multiple PLCs or controllers are connected to a single serial port. For example, StringGet(read_data_1[0], “FATEK KB Series”, RT, 2#5, 1) represents that the</p>	No.	Name	Location	Device type	Interf...	WF...	St...	Local HMI	Local HMI	Local	MT6056i (320 x...	Disable	N/A	N/A	Local Ser...	MODBUS RTU ...	Local	Free Protocol	COM1...	RS...	0	Remote P...	FATEK FB Series	Remote (IP:210.68.117.2...	FATEK FB Series	COM1...	RS...	1
No.	Name	Location	Device type	Interf...	WF...	St...																							
Local HMI	Local HMI	Local	MT6056i (320 x...	Disable	N/A	N/A																							
Local Ser...	MODBUS RTU ...	Local	Free Protocol	COM1...	RS...	0																							
Remote P...	FATEK FB Series	Remote (IP:210.68.117.2...	FATEK FB Series	COM1...	RS...	1																							

PLC's station number is 2. If StringGet() uses the default station number defined in the device list as follows, it is not necessary to define station number in address_offset.

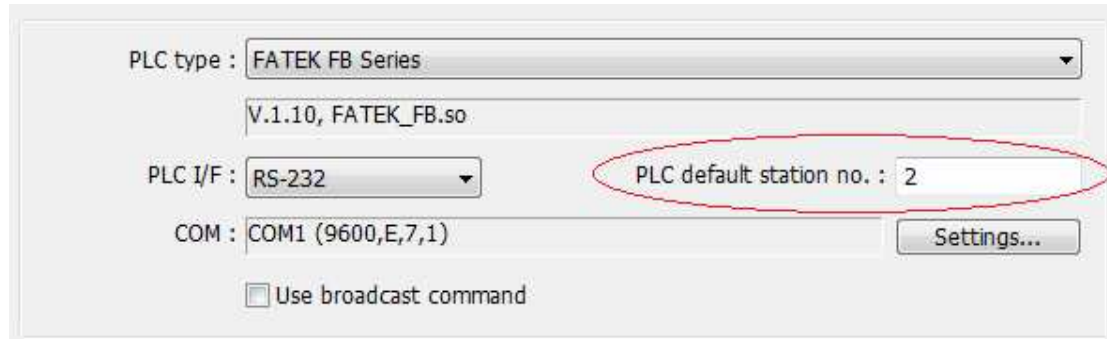

The number of registers actually read from depends on the value of the number of data_count since that the read_data is restricted to char array.

type of read_data	data_count	actual number of 16-bit register read
char (8-bit)	1	1
char (8-bit)	2	1

1 WORD register(16-bit) equals to the size of 2 ASCII characters. According to the above table, reading 2 ASCII characters is actually reading the content of one 16-bit register.

Example

```
macro_command main()
char str1[20]

// read 10 words from LW0~LW9 to the variables str1[0] to str1[19]
// since that 1 word can store 2 ASCII characters, reading 20 ASCII
// characters is actually reading 10 words of register
StringGet(str1[0], "Local HMI", LW, 0, 20)

end macro_command
```

Name	StringGetEx
Syntax	StringGetEx (read_data[start], device_name, device_type, address_offset, data_count)
Description	<p>Receives data from the PLC and continue executing next command even if no response from this device.</p> <p>Descriptions of read_data, device_name, device_type, address_offset and data_count are the same as GetData.</p>
Example	<pre> macro_command main() char str1[20] short test=0 // macro will continue executing test = 1 even if the MODBUS device is // not responding StringGetEx(str1[0], "MODBUS RTU", 4x, 0, 20) test = 1 // macro will not continue executing test = 2 until MODBUS device responds StringGet(str1[0], "MODBUS RTU", 4x, 0, 20) test = 2 end macro_command </pre>

Name	StringSet
Syntax	StringSet(send_data[start], device_name, device_type, address_offset, data_count)
Description	<p>Send data to the PLC. Data is defined in send_data[start]~ send_data[start + data_count - 1]. send_data must be a one-dimensional char array. data_count is the number of sent characters, it can be either a constant or a variable.</p> <p>device_name is the PLC name enclosed in the double quotation marks (“”) and this name has been defined in the device list of system parameters.</p> <p>device_type is the device type and encoding method (binary or BCD) of the PLC data. For example, if device_type is LW_BIN, it means the register is LW and the encoding method is binary. If use BIN encoding method, “_BIN” can be ignored.</p> <p>If device_type is LW_BCD, it means the register is LW and the encoding method is BCD.</p>

address_offset is the address offset in the PLC.

For example, StringSet(read_data_1[0], "FATEK KB Series", RT, 5, 1) represents that the address offset is 5.

If address_offset uses the format – "N#AAAAA", N indicates that PLC's station number is N. AAAAA represents the address offset. This format is used while multiple PLCs or controllers are connected to a single serial port. For example, StringSet(read_data_1[0], "FATEK KB Series", RT, 2#5, 1) represents that the PLC's station number is 2. If SetData () uses the default station number defined in the device list, it is not necessary to define station number in address_offset.

The number of registers actually sends to depends on the value of the number of data_count, since that send_data is restricted to char array.

type of read_data	data_count	actual number of 16-bit register send
char (8-bit)	1	1
char (8-bit)	2	1

1 WORD register(16-bit) equals to the size of 2 ASCII characters. According to the above table, sending 2 ASCII characters is actually writing to one 16-bit register. The ASCII characters are stored into the WORD register from low byte to high byte. While using the ASCII display object to display the string data stored in the registers, data_count must be a multiple of 2 in order to display full string content. For example:

```
macro_command main()
char src1[10]="abcde"
StringSet(src1[0], "Local HMI", LW, 0, 5)
end macro_command
```

The ASCII display object shows:



If data_count is an even number that is greater than or equal to the length of the string, the content of string can be completely shown:

	<pre>macro_command main() char src1[10]="abcde" StringSet(src1[0], "Local HMI", LW, 0, 6) end macro_command</pre> 
Example	<pre>macro_command main() char str1[10]="abcde" // Send 3 words to LW0~LW2 // Data are being sent until the end of string is reached. // Even though the value of data_count is larger than the length of string // , the function will automatically stop. StringSet(str1[0], "Local HMI", LW, 0, 10) end macro_command</pre>

Name	StringSetEx
Syntax	StringSetEx (send_data[start], device_name, device_type, address_offset, data_count)
Description	Send data to the PLC and continue executing next command even if no response from this device. Descriptions of send_data, device_name, device_type, address_offset and data_count are the same as StringSet.
Example	<pre>macro_command main() char str1[20]="abcde" short test=0 // macro will continue executing test = 1 even if the MODBUS device is // not responding StringSetEx(str1[0], "MODBUS RTU", 4x, 0, 20) test = 1 // macro will not continue executing test = 2 until MODBUS device responds StringSet(str1[0], "MODBUS RTU", 4x, 0, 20) test = 2</pre>

	end macro_command
--	-------------------

Name	StringCopy
Syntax	success = StringCopy ("source", destination[start]) or success = StringCopy (source[start], destination[start])
Description	<p>Copy one string to another. This function copies a static string (which is enclosed in quotes) or a string that is stored in an array to the destination buffer.</p> <p>The source string parameter accepts both static string (in the form: "source") and char array (in the form: source[start]).</p> <p>destination[start] must be an one-dimensional char array.</p> <p>This function returns a Boolean indicating whether the process is successfully done or not. If successful, it returns true, otherwise it returns false. If the length of source string exceeds the max. size of destination buffer, it returns false and the content of destination remains the same.</p> <p>The success field is optional.</p>
Example	<pre> macro_command main() char src1[5]="abcde" char dest1[5] bool success1 success1 = StringCopy(src1[0], dest1[0]) // success1=true, dest1="abcde" char dest2[5] bool success2 success2 = StringCopy("12345", dest2[0]) // success2=true, dest2="12345" char src3[10]="abcdefghij" char dest3[5] bool success3 success3 = StringCopy(src3[0], dest3[0]) // success3=false, dest3 remains the same. char src4[10]="abcdefghij" char dest4[5] bool success4 </pre>

	<pre> success4 = StringCopy(src4[5], dest4[0]) // success4=true, dest4="fghij" end macro_command </pre>
--	--

Name	StringDecAsc2Bin
Syntax	<pre> success = StringDecAsc2Bin(source[start], destination) or success = StringDecAsc2Bin("source", destination) </pre>
Description	<p>This function converts a decimal string to an integer. It converts the decimal string in source parameter into an integer, and stores it in the destination variable.</p> <p>The source string parameter accepts both static string (in the form: "source") and char array (in the form: source[start]).</p> <p>Destination must be a variable, to store the result of conversion.</p> <p>This function returns a Boolean indicating whether the process is successfully done or not. If successful, it returns true, otherwise it returns false. If the source string contains characters other than '0' to '9', it returns false.</p> <p>The success field is optional.</p>
Example	<pre> macro_command main() char src1[5]="12345" int result1 bool success1 success1 = StringDecAsc2Bin(src1[0], result1) // success1=true, result1 is 12345 char result2 bool success2 success2 = StringDecAsc2Bin("32768", result2) // success2=true, but the result exceeds the data range of result2 char src3[2]="4b" char result3 bool success3 success3 = StringDecAsc2Bin (src3[0], result3) // success3=false, because src3 contains characters other than '0' to '9' </pre>

	end macro_command
--	-------------------

Name	StringBin2DecAsc
Syntax	success = StringBin2DecAsc (source, destination[start])
Description	<p>This function converts an integer to a decimal string. It converts the integer in source parameter into a decimal string, and stores it in the destination buffer.</p> <p>Source can be either a constant or a variable.</p> <p>Destination must be an one-dimensional char array, to store the result of conversion.</p> <p>This function returns a Boolean indicating whether the process is successfully done or not. If successful, it returns true, otherwise it returns false. If the length of decimal string after conversion exceeds the size of destination buffer, it returns false.</p> <p>The success field is optional.</p>
Example	<pre> macro_command main() int src1 = 2147483647 char dest1[20] bool success1 success1 = StringBin2DecAsc(src1, dest1[0]) // success1=true, dest1="2147483647" short src2 = 0x3c char dest2[20] bool success2 success2 = StringBin2DecAsc(src2, dest2[0]) // success2=true, dest2="60" int src3 = 2147483647 char dest3[5] bool success3 success3 = StringBin2DecAsc(src3, dest3[0]) // success3=false, dest3 remains the same. end macro_command </pre>

Name	StringDecAsc2Float
Syntax	success = StringDecAsc2Float (source[start], destination)

	or success = StringDecAsc2Float ("source", destination)
Description	<p>This function converts a decimal string to floats. It converts the decimal string in source parameter into float, and stores it in the destination variable. The source string parameter accepts both static string (in the form: "source") and char array (in the form: source[start]).</p> <p>Destination must be a variable, to store the result of conversion.</p> <p>This function returns a Boolean indicating whether the process is successfully done or not. If successful, it returns true, otherwise it returns false. If the source string contains characters other than '0' to '9' or '.', it returns false.</p> <p>The success field is optional.</p>
Example	<pre> macro_command main() char src1[10]="12.345" float result1 bool success1 success1 = StringDecAsc2Float(src1[0], result1) // success1=true, result1 is 12.345 float result2 bool success2 success2 = StringDecAsc2Float("1.234567890", result2) // success2=true, but the result exceeds the data range of result2, which // might result in loss of precision char src3[2]="4b" float result3 bool success3 success3 = StringDecAsc2Float(src3[0], result3) // success3=false, because src3 contains characters other than '0' to '9' or // '.' end macro_command </pre>

Name	StringFloat2DecAsc
Syntax	success = StringFloat2DecAsc(source, destination[start])
Description	This function converts a float to a decimal string. It converts the float in source parameter into a decimal string, and stores it in the destination buffer.

	<p>Source can be either a constant or a variable.</p> <p>Destination must be an one-dimensional char array, to store the result of conversion.</p> <p>This function returns a Boolean indicating whether the process is successfully done or not. If successful, it returns true, otherwise it returns false. If the length of decimal string after conversion exceeds the size of destination buffer, it returns false.</p> <p>The success field is optional.</p>
Example	<pre>macro_command main() float src1 = 1.2345 char dest1[20] bool success1 success1 = StringFloat2DecAsc(src1, dest1[0]) // success1=true, dest1=" 1.2345" float src2 = 1.23456789 char dest2 [20] bool success2 success2 = StringFloat2DecAsc(src2, dest2 [0]) // success2=true, but it might lose precision float src3 = 1.2345 char dest3[5] bool success3 success3 = StringFloat2DecAsc(src3, dest3 [0]) // success3=false, dest3 remains the same. end macro_command</pre>

Name	StringHexAsc2Bin
Syntax	<pre>success = StringHexAsc2Bin (source[start], destination) or success = StringHexAsc2Bin ("source", destination)</pre>
Description	<p>This function converts a hexadecimal string to binary data. It converts the hexadecimal string in source parameter into binary data , and stores it in the destination variable.</p> <p>The source string parameter accepts both static string (in the form: "source") and char array (in the form: source[start]).</p>

	<p>Destination must be a variable, to store the result of conversion.</p> <p>This function returns a Boolean indicating whether the process is successfully done or not. If successful, it returns true, otherwise it returns false. If the source string contains characters other than '0' to '9', 'a' to 'f' or 'A' to 'F', it returns false.</p> <p>The success field is optional.</p>
Example	<pre>macro_command main() char src1[5]="0x3c" int result1 bool success1 success1 = StringHexAsc2Bin(src1[0], result1) // success1=true, result1 is 3c short result2 bool success2 success2 = StringDecAsc2Bin("1a2b3c4d", result2) // success2=true, result2=3c4d.The result exceeds the data range of // result2 char src3[2]="4g" char result3 bool success3 success3 = StringDecAsc2Bin (src3[0], result3) // success3=false, because src3 contains characters other than '0' to '9' // , 'a' to 'f' or 'A' to 'F' end macro_command</pre>

Name	StringBin2HexAsc
Syntax	success = StringBin2HexAsc (source, destination[start])
Description	<p>This function converts binary data to a hexadecimal string. It converts the binary data in source parameter into a hexadecimal string, and stores it in the destination buffer.</p> <p>Source can be either a constant or a variable.</p> <p>Destination must be an one-dimensional char array, to store the result of conversion.</p> <p>This function returns a Boolean indicating whether the process is successfully done or not. If successful, it returns true, otherwise it returns</p>

	<p>false. If the length of hexadecimal string after conversion exceeds the size of destination buffer, it returns false.</p> <p>The success field is optional.</p>
Example	<pre>macro_command main() int src1 = 20 char dest1[20] bool success1 success1 = StringBin2HexAsc(src1, dest1[0]) // success1=true, dest1="14" short src2 = 0x3c char dest2[20] bool success2 success2 = StringBin2HexAsc(src2, dest2[0]) // success2=true, dest2="3c" int src3 = 0x1a2b3c4d char dest3[6] bool success3 success3 = StringBin2HexAsc(src3, dest3[0]) // success3=false, dest3 remains the same. end macro_command</pre>

Name	StringMid
Syntax	<pre>success = StringMid (source[start], count, destination[start]) or success = StringMid ("string", start, count, destination[start])</pre>
Description	<p>Retrieve a character sequence from the specified offset of the source string and store it in the destination buffer.</p> <p>The source string parameter accepts both static string (in the form: "source") and char array (in the form: source[start]). For source[start], the start offset of the substring is specified by the index value. For static source string("source"), the second parameter(start) specifies the start offset of the substring.</p> <p>The count parameter specifies the length of substring being retrieved.</p> <p>Destination must be an one-dimensional char array, to store the retrieved substring.</p>

	<p>This function returns a Boolean indicating whether the process is successfully done or not. If successful, it returns true, otherwise it returns false. If the length of retrieved substring exceeds the size of destination buffer, it returns false.</p> <p>The success field is optional.</p>
Example	<pre>macro_command main() char src1[20]="abcdefghijklmnopqrst" char dest1[20] bool success1 success1 = StringMid(src1[5], 6, dest1[0]) // success1=true, dest1="fghijk" char src2[20]="abcdefghijklmnopqrst" char dest2[5] bool success2 success2 = StringMid(src2[5], 6, dest2[0]) // success2=false, dest2 remains the same. char dest3[20]="12345678901234567890" bool success3 success3 = StringMid("abcdefghijklmnopqrst", 5, 5, dest3[15]) // success3= true, dest3=" 123456789012345fghij" end macro_command</pre>

Name	StringLength
Syntax	<pre>length = StringLength (source[start]) or length = StringLength ("source")</pre>
Description	<p>Obtain the length of a string. It returns the length of source string and stores it in the length field on the left-hand side of '=' operator.</p> <p>The source string parameter accepts both static string (in the form: "source") and char array (in the form: source[start]).</p> <p>The return value of this function indicates the length of the source string.</p>
Example	<pre>macro_command main() char src1[20]="abcde" int length1 length1= StringLength(src1[0])</pre>

	<pre>// length1=5 char src2[20]={'a', 'b', 'c', 'd', 'e'} int length2 length2= StringLength(src2[0]) // length2=20 char src3[20]="abcdefghij" int length3 length3= StringLength(src3 [2]) // length3=8 end macro_command</pre>
--	---

Name	StringCat
Syntax	<pre>success = StringCat (source[start], destination[start]) or success = StringCat ("source", destination[start])</pre>
Description	<p>This function appends source string to destination string. It adds the contents of source string to the last of the contents of destination string. The source string parameter accepts both static string (in the form: "source") and char array (in the form: source[start]). Destination must be an one-dimensional char array.</p> <p>This function returns a Boolean indicating whether the process is successfully done or not. If successful, it returns true, otherwise it returns false. If the length of result string after concatenation exceeds the max. size of destination buffer, it returns false.</p> <p>The success field is optional.</p>
Example	<pre>macro_command main() char src1[20]="abcdefghij" char dest1[20]="1234567890" bool success1 success1= StringCat(src1[0], dest1[0]) // success1=true, dest1="123456790abcdefghij" char dest2 [10]="1234567890" bool success2 success2= StringCat("abcde", dest2 [0])</pre>

	<pre>// success2=false, dest2 remains the same. char src3[20]="abcdefghij" char dest3[20] bool success3 success3= StringCat(src3[0], dest3[15]) // success3=false, dest3 remains the same. end macro_command</pre>
--	--

Name	StringCompare
Syntax	<pre>ret = StringCompare (str1[start], str2[start]) ret = StringCompare ("string1", str2[start]) ret = StringCompare (str1[start], "string2") ret = StringCompare ("string1", "string2")</pre>
Description	<p>Do a case-sensitive comparison of two strings.</p> <p>The two string parameters accept both static string (in the form: "string1") and char array (in the form: str1[start]).</p> <p>This function returns a Boolean indicating the result of comparison. If two strings are identical, it returns true. Otherwise it returns false.</p> <p>The ret field is optional.</p>
Example	<pre>macro_command main() char a1[20]="abcde" char b1[20]="ABCDE" bool ret1 ret1= StringCompare(a1[0], b1[0]) // ret1=false char a2[20]="abcde" char b2[20]="abcde" bool ret2 ret2= StringCompare(a2[0], b2[0]) // ret2=true char a3 [20]="abcde" char b3[20]="abcdefg" bool ret3 ret3= StringCompare(a3[0], b3[0])</pre>

	<pre>// ret3=false end macro_command</pre>
--	---

Name	StringCompareNoCase
Syntax	<pre>ret = StringCompareNoCase(str1[start], str2[start]) ret = StringCompareNoCase("string1", str2[start]) ret = StringCompareNoCase(str1[start], "string2") ret = StringCompareNoCase("string1", "string2")</pre>
Description	<p>Do a case-insensitive comparison of two strings.</p> <p>The two string parameters accept both static string (in the form: "string1") and char array (in the form: str1[start]).</p> <p>This function returns a Boolean indicating the result of comparison. If two strings are identical, it returns true. Otherwise it returns false.</p> <p>The ret field is optional.</p>
Example	<pre>macro_command main() char a1[20]="abcde" char b1[20]="ABCDE" bool ret1 ret1= StringCompareNoCase(a1[0], b1[0]) // ret1=true char a2[20]="abcde" char b2[20]="abcde" bool ret2 ret2= StringCompareNoCase(a2[0], b2[0]) // ret2=true char a3 [20]="abcde" char b3[20]="abcdefg" bool ret3 ret3= StringCompareNoCase(a3[0], b3[0]) // ret3=false end macro_command</pre>

Name	StringFind
Syntax	position = StringFind (source[start], target[start])

	<pre>position = StringFind ("source", target[start]) position = StringFind (source[start], "target") position = StringFind ("source", "target")</pre>
Description	<p>Return the position of the first occurrence of target string in the source string.</p> <p>The two string parameters accept both static string (in the form: "source") and char array (in the form: source[start]).</p> <p>This function returns the zero-based index of the first character of substring in the source string that matches the target string. Notice that the entire sequence of characters to find must be matched. If there is no matched substring, it returns -1.</p>
Example	<pre>macro_command main() char src1[20]="abcde" char target1[20]="cd" bool pos1 pos1= StringFind(src1[0], target1[0]) // pos1=2 char target2[20]="ce" bool pos2 pos2= StringFind("abcde", target2[0]) // pos2=-1 char src3[20]="abcde" bool pos3 pos3= StringFind(src3[3], "cd") // pos3=-1 end macro_command</pre>

Name	StringReverseFind
Syntax	<pre>position = StringReverseFind (source[start], target[start]) position = StringReverseFind ("source", target[start]) position = StringReverseFind (source[start], "target") position = StringReverseFind ("source", "target")</pre>
Description	<p>Return the position of the last occurrence of target string in the source string.</p> <p>The two string parameters accept both static string (in the form: "source")</p>

	<p>and char array (in the form: source[start]).</p> <p>This function returns the zero-based index of the first character of substring in the source string that matches the target string. Notice that the entire sequence of characters to find must be matched. If there exists multiple substrings that matches the target string, function will return the position of the last matched substring. If there is no matched substring, it returns -1.</p>
Example	<pre>macro_command main() char src1[20]="abcdeabcde" char target1[20]="cd" bool pos1 pos1= StringReverseFind(src1[0], target1[0]) // pos1=7 char target2[20]="ce" bool pos2 pos2= StringReverseFind("abcdeabcde", target2[0]) // pos2=-1 char src3[20]="abcdeabcde" bool pos3 pos3= StringReverseFind(src3[6], "ab") // pos3=-1 end macro_command</pre>

Name	StringFindOneOf
Syntax	<pre>position = StringFindOneOf (source[start], target[start]) position = StringFindOneOf ("source", target[start]) position = StringFindOneOf (source[start], "target") position = StringFindOneOf ("source", "target")</pre>
Description	<p>Return the position of the first character in the source string that matches any character contained in the target string.</p> <p>The two string parameters accept both static string (in the form: "source") and char array (in the form: source[start]).</p> <p>This function returns the zero-based index of the first character in the source string that is also in the target string. If there is no match, it returns -1.</p>
Example	<pre>macro_command main()</pre>

	<pre> char src1[20]="abcdeabcde" char target1[20]="sdf" bool pos1 pos1= StringFindOneOf(src1[0], target1[0]) // pos1=3 char src2[20]="abcdeabcde" bool pos2 pos2= StringFindOneOf(src2[1], "agi") // pos2=4 char target3 [20]="bus" bool pos3 pos3= StringFindOneOf("abcdeabcde", target3[1]) // pos3=-1 end macro_command </pre>
--	--

Name	StringIncluding
Syntax	<pre> success = StringIncluding (source[start], set[start], destination[start]) success = StringIncluding ("source", set[start], destination[start]) success = StringIncluding (source[start], "set", destination[start]) success = StringIncluding ("source", "set", destination[start]) </pre>
Description	<p>Retrieve a substring of the source string that contains characters in the set string, beginning with the first character in the source string and ending when a character is found in the source string that is not in the target string. The source string and set string parameters accept both static string (in the form: "source") and char array (in the form: source[start]).</p> <p>This function returns a Boolean indicating whether the process is successfully done or not. If successful, it returns true, otherwise it returns false. If the length of retrieved substring exceeds the size of destination buffer, it returns false.</p>
Example	<pre> macro_command main() char src1[20]="cabbageabc" char set1[20]="abc" char dest1[20] bool success1 success1 = StringIncluding(src1[0], set1[0], dest1[0]) </pre>

	<pre>// success1=true, dest1="cabba" char src2[20]="gecabba" char dest2[20] bool success2 success2 = StringIncluding(src2[0], "abc", dest2[0]) // success2=true, dest2="" char set3[20]="abc" char dest3[4] bool success3 success3 = StringIncluding("cabbage", set3[0], dest3[0]) // success3=false, dest3 remains the same. end macro_command</pre>
--	--

Name	StringExcluding
Syntax	<pre>success = StringExcluding (source[start], set[start], destination[start]) success = StringExcluding ("source", set[start], destination[start]) success = StringExcluding (source[start], "set", destination[start]) success = StringExcluding ("source", "set", destination[start])</pre>
Description	<p>Retrieve a substring of the source string that contains characters that are not in the set string, beginning with the first character in the source string and ending when a character is found in the source string that is also in the target string.</p> <p>The source string and set string parameters accept both static string (in the form: "source") and char array (in the form: source[start]).</p> <p>This function returns a Boolean indicating whether the process is successfully done or not. If successful, it returns true, otherwise it returns false. If the length of retrieved substring exceeds the size of destination buffer, it returns false.</p>
Example	<pre>macro_command main() char src1[20]="cabbageabc" char set1[20]="ge" char dest1[20] bool success1 success1 = StringExcluding(src1[0], set1[0], dest1[0]) // success1=true, dest1="cabba"</pre>

	<pre> char src2[20]="cabbage" char dest2[20] bool success2 success2 = StringExcluding(src2[0], "abc", dest2[0]) // success2=true, dest2="" char set3[20]="ge" char dest3[4] bool success3 success3 = StringExcluding("cabbage", set3[0], dest3[0]) // success3=false, dest3 remains the same. end macro_command </pre>
--	--

Name	StringToUpper
Syntax	<pre> success = StringToUpper (source[start], destination[start]) success = StringToUpper ("source", destination[start]) </pre>
Description	<p>Convert all the characters in the source string to uppercase characters and store the result in the destination buffer.</p> <p>The source string parameter accepts both static string (in the form: "source") and char array (in the form: source[start]).</p> <p>This function returns a Boolean indicating whether the process is successfully done or not. If successful, it returns true, otherwise it returns false. If the length of result string after conversion exceeds the size of destination buffer, it returns false.</p>
Example	<pre> macro_command main() char src1[20]="aBcDe" char dest1[20] bool success1 success1 = StringToUpper(src1[0], dest1[0]) // success1=true, dest1="ABCDE" char dest2[4] bool success2 success2 = StringToUpper("aBcDe", dest2[0]) // success2=false, dest2 remains the same. </pre>

	end macro_command
--	-------------------

Name	StringToLower
Syntax	<pre>success = StringToLower (source[start], destination[start]) success = StringToLower ("source", destination[start])</pre>
Description	<p>Convert all the characters in the source string to lowercase characters and store the result in the destination buffer.</p> <p>The source string parameter accepts both static string (in the form: "source") and char array (in the form: source[start]).</p> <p>This function returns a Boolean indicating whether the process is successfully done or not. If successful, it returns true, otherwise it returns false. If the length of result string after conversion exceeds the size of destination buffer, it returns false.</p>
Example	<pre>macro_command main() char src1[20]="aBcDe" char dest1[20] bool success1 success1 = StringToUpper(src1[0], dest1[0]) // success1=true, dest1="abcde" char dest2[4] bool success2 success2 = StringToUpper("aBcDe", dest2[0]) // success2=false, dest2 remains the same. end macro_command</pre>

Name	StringToReverse
Syntax	<pre>success = StringToReverse (source[start], destination[start]) success = StringToReverse ("source", destination[start])</pre>
Description	<p>Reverse the characters in the source string and store it in the destination buffer.</p> <p>The source string parameter accepts both static string (in the form: "source") and char array (in the form: source[start]).</p> <p>This function returns a Boolean indicating whether the process is successfully done or not. If successful, it returns true, otherwise it returns false. If the length of reversed string exceeds the size of destination buffer, it returns false.</p>

Example	<pre> macro_command main() char src1[20]="abcde" char dest1[20] bool success1 success1 = StringToUpper(src1[0], dest1[0]) // success1=true, dest1="edcba" char dest2[4] bool success2 success2 = StringToUpper("abcde", dest2[0]) // success2=false, dest2 remains the same. end macro_command </pre>
----------------	---

Name	StringTrimLeft
Syntax	<pre> success = StringTrimLeft (source[start], set[start], destination[start]) success = StringTrimLeft ("source", set[start], destination[start]) success = StringTrimLeft (source[start], "set", destination[start]) success = StringTrimLeft ("source", "set", destination[start]) </pre>
Description	<p>Trim the leading specified characters in the set buffer from the source string.</p> <p>The source string and set string parameters accept both static string (in the form: "source") and char array (in the form: source[start]).</p> <p>This function returns a Boolean indicating whether the process is successfully done or not. If successful, it returns true, otherwise it returns false. If the length of trimmed string exceeds the size of destination buffer, it returns false.</p>
Example	<pre> macro_command main() char src1[20]= "# *a*#bc" char set1[20]="# *" char dest1[20] bool success1 success1 = StringTrimLeft (src1[0], set1[0], dest1[0]) // success1=true, dest1="a*#bc" char set2[20]={'#', ' ', '*'} char dest2[4] success2 = StringTrimLeft ("# *a*#bc", set2[0], dest2[0]) </pre>

	<pre>// success2=false, dest2 remains the same. char src3[20]="abc *#" char dest3[20] bool success3 success3 = StringTrimLeft (src3[0], "# *", dest3[0]) // success3=true, dest3="abc *#" end macro_command</pre>
--	---

Name	StringTrimRight
Syntax	<pre>success = StringTrimRight (source[start], set[start], destination[start]) success = StringTrimRight ("source", set[start], destination[start]) success = StringTrimRight (source[start], "set", destination[start]) success = StringTrimRight ("source", "set", destination[start])</pre>
Description	<p>Trim the trailing specified characters in the set buffer from the source string. The source string and set string parameters accept both static string (in the form: "source") and char array (in the form: source[start]).</p> <p>This function returns a Boolean indicating whether the process is successfully done or not. If successful, it returns true, otherwise it returns false. If the length of trimmed string exceeds the size of destination buffer, it returns false.</p>
Example	<pre>macro_command main() char src1[20]= "# *a*#bc# * " char set1[20]="# *" char dest1[20] bool success1 success1 = StringTrimRight(src1[0], set1[0], dest1[0]) // success1=true, dest1="# *a*#bc" char set2[20]={'#', ' ', '*'} char dest2[20] success2 = StringTrimRight("# *a*#bc", set2[0], dest2[0]) // success2=true, dest2="# *a*#bc" char src3[20]="ab**c *#" char dest3[4] bool success3</pre>

	<pre> success3 = StringTrimRight(src3[0], "# *", dest3[0]) // success3=false, dest3 remains the same. end macro_command </pre>
--	---

Name	StringInsert
Syntax	<pre> success = StringInsert (pos, insert[start], destination[start]) success = StringInsert (pos, "insert", destination[start]) success = StringInsert (pos, insert[start], length, destination[start]) success = StringInsert (pos, "insert", length, destination[start]) </pre>
Description	<p>Insert a string in a specific location within the destination string content. The insert location is specified by the pos parameter.</p> <p>The insert string parameter accepts both static string (in the form: "source") and char array (in the form: source[start]).</p> <p>The number of characters to insert can be specified by the length parameter.</p> <p>This function returns a Boolean indicating whether the process is successfully done or not. If successful, it returns true, otherwise it returns false. If the length of string after insertion exceeds the size of destination buffer, it returns false.</p>
Example	<pre> macro_command main() char str1[20]="but the question is" char str2[10]=", that is" char dest[40]="to be or not to be" bool success success = StringInsert(18, str1[3], 13, dest[0]) // success=true, dest="to be or not to be the question" success = StringInsert(18, str2[0], dest[0]) // success=true, dest="to be or not to be, that is the question" success = StringInsert(0, "Hamlet:", dest[0]) // success=false, dest remains the same. end macro_command </pre>

18.6.7 Miscellaneous

Name	SYNC_TRIG_MACRO
Syntax	SYNC_TRIG_MACRO(macro_id)
Description	<p>Trigger the execution of a macro synchronously (use macro_id to designate this macro) in a running macro.</p> <p>The current macro will pause until the end of execution of this called macro.</p> <p>macro_id can be a constant or a variable.</p>
Example	<pre>macro_command main() char ON = 1, OFF = 0 SetData(ON, "Local HMI", LB, 0, 1) SYNC_TRIG_MACRO(5)// call a macro (its ID is 5) SetData(OFF, "Local HMI", LB, 0, 1) end macro_command</pre>

Name	ASYNCRIG_MACRO
Syntax	ASYNCRIG_MACRO (macro_id)
Description	<p>Trigger the execution of a macro asynchronously (use macro_id to designate this macro) in a running macro.</p> <p>The current macro will continue executing the following instructions after triggering the designated macro; in other words, the two macros will be active simultaneously.</p> <p>macro_id can be a constant or a variable.</p>
Example	<pre>macro_command main() char ON = 1, OFF = 0 SetData(ON, "Local HMI", LB, 0, 1) ASYNCRIG_MACRO(5)// call a macro (its ID is 5) SetData(OFF, "Local HMI", LB, 0, 1) end macro_command</pre>

Name	TRACE																
Syntax	TRACE(format, argument)																
Description	<p>Use this function to send specified string to the EasyDiagnoser. Users can print out the current value of variables during run-time of macro for debugging.</p> <p>When TRACE encounters the first format specification (if any), it converts the value of the first argument after format and outputs it accordingly. <i>format</i> refers to the format control of output string. A format specification, which consists of optional (in []) and required fields (in bold), has the following form:</p> <p style="text-align: center;">%[flags] [width] [.precision] type</p> <p>Each field of the format specification is described as below:</p> <p><i>flags</i> (optional):</p> <p style="padding-left: 40px;">- +</p> <p><i>width</i> (optional):</p> <p style="padding-left: 40px;">A nonnegative decimal integer controlling the minimum number of characters printed.</p> <p><i>precision</i> (optional):</p> <p style="padding-left: 40px;">A nonnegative decimal integer which specifies the precision and the number of characters to be printed.</p> <p><i>type</i>:</p> <table style="margin-left: 40px;"> <tr> <td>C or c</td> <td>: specifies a single-byte character.</td> </tr> <tr> <td>d</td> <td>: signed decimal integer.</td> </tr> <tr> <td>i</td> <td>: signed decimal integer.</td> </tr> <tr> <td>o</td> <td>: unsigned octal integer.</td> </tr> <tr> <td>u</td> <td>: unsigned decimal integer.</td> </tr> <tr> <td>X or x</td> <td>: unsigned hexadecimal integer.</td> </tr> <tr> <td>E or e</td> <td>: Signed value having the form. [-]<i>d</i>.<i>dddd</i> e [<i>sign</i>]<i>ddd</i> where <i>d</i> is a single decimal digit, <i>dddd</i> is one or more decimal digits, <i>ddd</i> is exactly three decimal digits, and <i>sign</i> is + or -.</td> </tr> <tr> <td>f</td> <td>: Signed value having the form [-]<i>dddd</i>.<i>dddd</i>, where <i>dddd</i> is one or more decimal digits.</td> </tr> </table> <p>The length of output string is limited to 256 characters. The extra characters will be ignored.</p>	C or c	: specifies a single-byte character.	d	: signed decimal integer.	i	: signed decimal integer.	o	: unsigned octal integer.	u	: unsigned decimal integer.	X or x	: unsigned hexadecimal integer.	E or e	: Signed value having the form. [-] <i>d</i> . <i>dddd</i> e [<i>sign</i>] <i>ddd</i> where <i>d</i> is a single decimal digit, <i>dddd</i> is one or more decimal digits, <i>ddd</i> is exactly three decimal digits, and <i>sign</i> is + or -.	f	: Signed value having the form [-] <i>dddd</i> . <i>dddd</i> , where <i>dddd</i> is one or more decimal digits.
C or c	: specifies a single-byte character.																
d	: signed decimal integer.																
i	: signed decimal integer.																
o	: unsigned octal integer.																
u	: unsigned decimal integer.																
X or x	: unsigned hexadecimal integer.																
E or e	: Signed value having the form. [-] <i>d</i> . <i>dddd</i> e [<i>sign</i>] <i>ddd</i> where <i>d</i> is a single decimal digit, <i>dddd</i> is one or more decimal digits, <i>ddd</i> is exactly three decimal digits, and <i>sign</i> is + or -.																
f	: Signed value having the form [-] <i>dddd</i> . <i>dddd</i> , where <i>dddd</i> is one or more decimal digits.																

	The <i>argument</i> part is optional. One format specification converts exactly one argument.
Example	<pre>macro_command main() char c1 = 'a' short s1 = 32767 float f1 = 1.234567 TRACE("The results are") // output: The results are TRACE("c1 = %c, s1 = %d, f1 = %f", c1, s1, f1) // output: c1 = a, s1 = 32767, f1 = 1.234567 end macro_command</pre>

Name	FindDataSamplingDate																																
Syntax	<pre>return_value = FindDataSamplingDate (data_log_number, index, year, month, d or FindDataSamplingDate (data_log_number, index, year, month, day)</pre>																																
Description	<p>A query function for finding the date of specified data sampling file according to sampling no. and the file index. The date is stored into "year", "month" and "day" respectively in the format of YYYY, MM and DD.</p> <table border="1" data-bbox="459 1167 1596 1377"> <thead> <tr> <th colspan="8">Data Sampling Object</th> </tr> <tr> <th>No.</th> <th>Description</th> <th>Read address</th> <th>Sample mode</th> <th>Trigger address</th> <th>Clear address</th> <th>Hold address</th> <th></th> </tr> </thead> <tbody> <tr> <td>1</td> <td></td> <td>Local HMI : L.WO</td> <td>Periodical</td> <td>Disable</td> <td>Disable</td> <td>Disable</td> <td></td> </tr> <tr> <td>2</td> <td></td> <td>Local HMI : L.WO</td> <td>Periodical</td> <td>Disable</td> <td>Disable</td> <td>Disable</td> <td></td> </tr> </tbody> </table> <p>data sampling no.</p> <p>The directory of saved data: [Storage location]\[filename]\yyyymmdd.dtl. The sampling files under the same directory are sorted according to the file name indexed starting from 0. The most recently saved file has the smallest file index.</p> <p>For example, if there are four data sampling files as follows:</p> <pre>20101210.dtl 20101230.dtl 20110110.dtl 20110111.dtl</pre> <p>The file index are:</p> <pre>20101210.dtl -> index is 3 20101230.dtl -> index is 2 20110110.dtl -> index is 1 20110111.dtl -> index is 0</pre>	Data Sampling Object								No.	Description	Read address	Sample mode	Trigger address	Clear address	Hold address		1		Local HMI : L.WO	Periodical	Disable	Disable	Disable		2		Local HMI : L.WO	Periodical	Disable	Disable	Disable	
Data Sampling Object																																	
No.	Description	Read address	Sample mode	Trigger address	Clear address	Hold address																											
1		Local HMI : L.WO	Periodical	Disable	Disable	Disable																											
2		Local HMI : L.WO	Periodical	Disable	Disable	Disable																											

	<p>“return_value” equals to 1 if referred data sampling file is successfully found, otherwise equals to 0.</p> <p>“data_log_number” and “index” can be constant or variable. “year”, “month”, “day” and “return_value” must be variable.</p> <p>The “return_value” field is optional.</p>
Example	<pre>macro_command main() short data_log_number = 1, index = 2, year, month, day short success // if there exists a data sampling file named 20101230.dtl, with data sampling // number // and file index 2. // the result after execution: success == 1, year == 2010, month == 12 and //day == 30 success = FindDataSamplingDate(data_log_number, index, year, month, day) end macro_command</pre>

Name	FindDataSamplingIndex																																
Syntax	return_value = FindDataSamplingIndex (data_log_number, year, month, day, index) or FindDataSamplingIndex (data_log_number, year, month, day, index)																																
Description	<p>A query function for finding the file index of specified data sampling file according to the data sampling no. and the date. The file index is stored into “index”. “year”, “month”, “day” are in the format of YYYY, MM and DD respectively.</p> <table border="1" data-bbox="459 1317 1596 1523"> <thead> <tr> <th colspan="8">Data Sampling Object</th> </tr> <tr> <th>No.</th> <th>Description</th> <th>Read address</th> <th>Sample mode</th> <th>Trigger address</th> <th>Clear address</th> <th>Hold address</th> <th></th> </tr> </thead> <tbody> <tr> <td>1</td> <td></td> <td>Local HMI : L.WO</td> <td>Periodical</td> <td>Disable</td> <td>Disable</td> <td>Disable</td> <td></td> </tr> <tr> <td>2</td> <td></td> <td>Local HMI : L.WO</td> <td>Periodical</td> <td>Disable</td> <td>Disable</td> <td>Disable</td> <td></td> </tr> </tbody> </table> <p>data sampling no.</p> <p>The directory of saved data: [Storage location]\[filename]\yyyymmdd.dtl. The data sampling files under the same directory are sorted according to the file name and indexed starting from 0. The most recently saved file has the smallest file index.</p> <p>For example, if there are four data sampling files as follows:</p> <p>20101210.dtl 20101230.dtl 20110110.dtl 20110111.dtl</p> <p>The file index are:</p> <p>20101210.dtl -> index is 3</p>	Data Sampling Object								No.	Description	Read address	Sample mode	Trigger address	Clear address	Hold address		1		Local HMI : L.WO	Periodical	Disable	Disable	Disable		2		Local HMI : L.WO	Periodical	Disable	Disable	Disable	
Data Sampling Object																																	
No.	Description	Read address	Sample mode	Trigger address	Clear address	Hold address																											
1		Local HMI : L.WO	Periodical	Disable	Disable	Disable																											
2		Local HMI : L.WO	Periodical	Disable	Disable	Disable																											

	<p>20101230.dtl -> index is 2 20110110.dtl -> index is 1 20110111.dtl -> index is 0</p> <p>“return_value” equals to 1 if referred data sampling file is successfully found, otherwise equals to 0.</p> <p>“data_log_number”, “year”, “month” and “day” can be constant or variable. “index” must be variable.</p> <p>The “return_value” field is optional.</p>
Example	<pre>macro_command main() short data_log_number = 1, year = 2010, month = 12, day = 10, index short success // if there exists a data sampling file named 20101210.dtl, with data sampling // r and file index 2. // the result after execution: success == 1 and index == 2 success = FindDataSamplingIndex (data_log_number, year, month, day, index) end macro_command</pre>

Name	FindEventLogDate
Syntax	return_value = FindEventLogDate (index, year, month, day) or FindEventLogDate (index, year, month, day)
Description	<p>A query function for finding the date of specified event log file according to file index. The date is stored into “year”, “month” and “day” respectively in the format of YYYY, MM and DD.</p> <p>The event log files stored in the designated position (such as HMI memory storage or external memory device) are sorted according to the file name and are indexed starting from 0. The most recently saved file has the smallest file index number. For example, if there are four event log files as follows:</p> <pre>EL_20101210.evt EL_20101230.evt EL_20110110.evt EL_20110111.evt</pre> <p>The file index are:</p> <pre>EL_20101210.evt -> index is 3 EL_20101230.evt -> index is 2</pre>

	<p>EL_20110110.evt -> index is 1 EL_20110111.evt -> index is 0 “return_value” equals to 1 if referred data sampling file is successfully found, otherwise it equals to 0. “index” can be constant or variable. “year”, “month”, “day” and “return_value” must be variable. The “return_value” field is optional.</p>
Example	<pre>macro_command main() short index = 1, year, month, day short success // if there exists an event log file named EL_20101230.evt , with index 1 // the result after execution: success == 1, year == 2010, month == 12, day //== 30 success = FindEventLogDate (index, year, month, day) end macro_command</pre>

Name	FindEventLogIndex
Syntax	return_value = FindEventLogIndex (year, month, day, index) or FindEventLogIndex (year, month, day, index)
Description	<p>A query function for finding the file index of specified event log file according to date. The file index is stored into “index”. “year”, “month” and “day” are in the format of YYYY, MM and DD respectively.</p> <p>The event log files stored in the designated position (such as HMI memory storage or external memory device) are sorted according to the file name and are indexed starting from 0. The most recently saved file has the smallest file index number. For example, if there are four event log files as follows:</p> <pre>EL_20101210.evt EL_20101230.evt EL_20110110.evt EL_20110111.evt</pre> <p>The file index are:</p> <pre>EL_20101210.evt -> index is 3 EL_20101230.evt -> index is 2</pre>

	<p>EL_20110110 evt -> index is 1 EL_20110111 evt -> index is 0 “return_value” equals to 1 if referred data sampling file is successfully found, otherwise it equals to 0. “year”, “month” and “day” can be constant or variable. “index” and “return_value” must be variable. The “return_value” field is optional.</p>
Example	<pre>macro_command main() short year = 2010, month = 12, day = 10, index short success // if there exists an event log file named EL_20101210 evt, with index 2 // the result after execution: success == 1, index == 2 success = FindEventLogIndex (year, month, day, index) end macro_command</pre>

18.7 How to Create and Execute a Macro

18.7.1 How to Create a Macro

Macro programming can be divided into some steps as follows,

Step 1:

Click on “Macro Manager” icon on the tool bar of EasyBuilder 8000 to open Macro Manager dialogue box as follows.

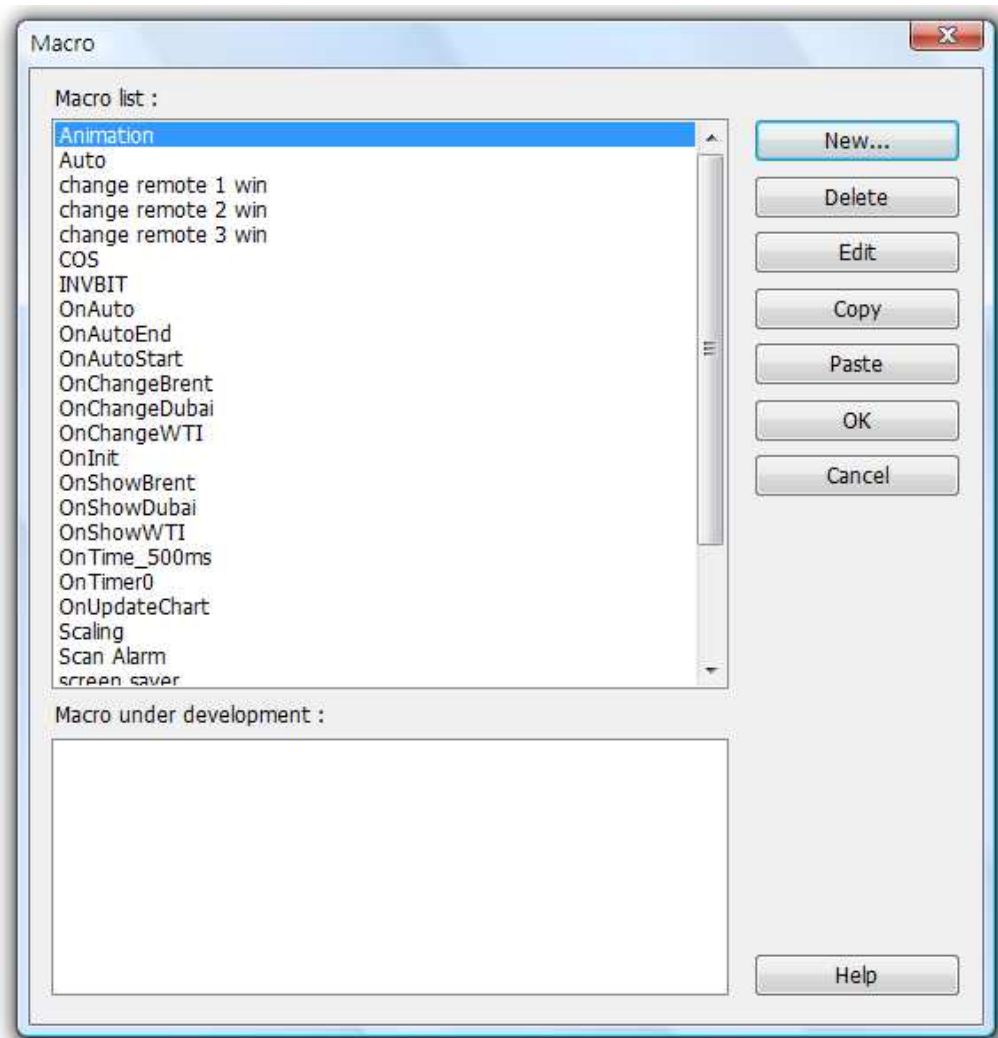

On Macro Manager, all macros compiled successfully are displayed in “Macro list”, and all macros in developing are displayed in ‘Macro under development’. The following is a description of the various buttons.

[New]

Opens a blank “WorkSpace” editor for creating a new macro.

[Delete]

Deletes the selected macro.

[Edit]

Opens the “WorkSpace” editor, and loads the selected macro.

[Copy]

Copies the selected macro into the clipboard.

[Paste]

Pastes the macro in the clipboard into the list, and creates a new name for the macro.

Step 2:

Press the “New” button to open a blank “WorkSpace” editor. Every macro has a unique number defined in “Macro ID” edit box, and macro name must exist, otherwise an error will appear while compiling.

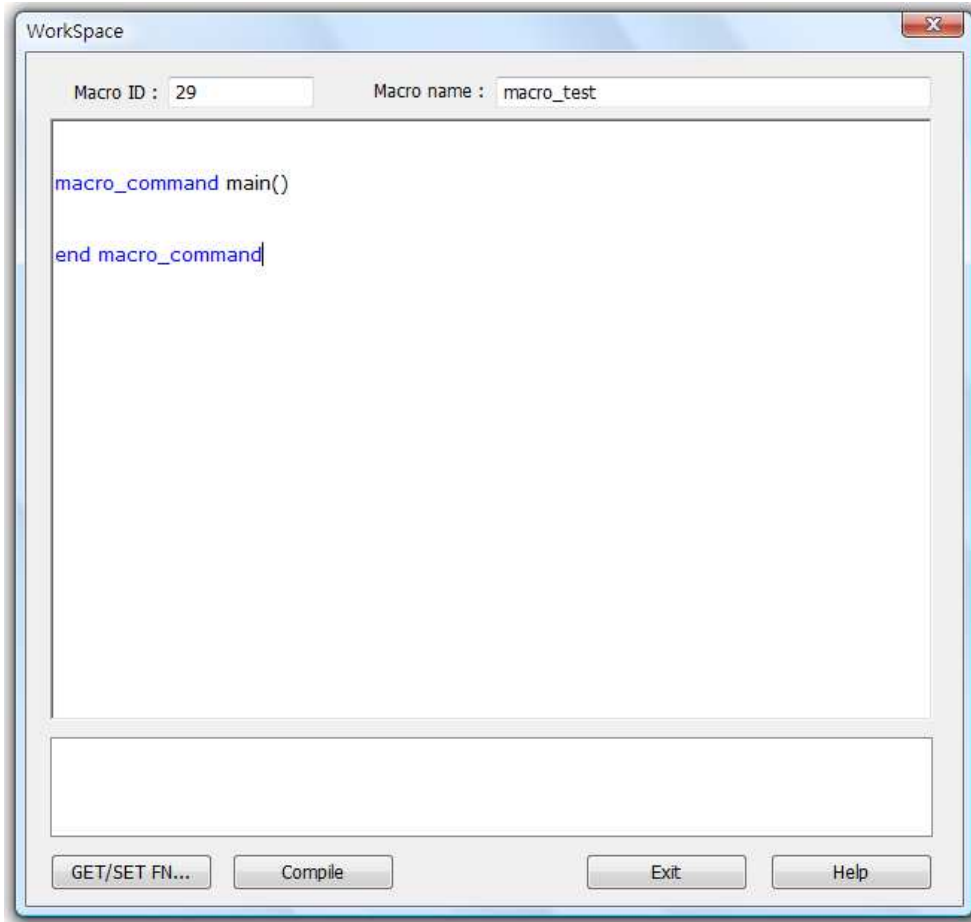
**Step 3:**

Design your macro. If it is necessary to use build-in functions (like SetData() or Getdata()), press 'Get/Set FN...' button to open API dialog and select the function and set essential parameters.

The screenshot shows the 'API' dialog box for the 'GetData' macro. The 'Function name' is 'GetData'. The macro signature is 'GetData(data[0], "Local HMI", LW, 0, 4)'. Under 'Variable 1', the 'Variable type' is 'short (16-bit)', the 'Variable' is 'data', and the 'Array index' is '0'. The 'Read address' section shows 'PLC name' as 'Local HMI', 'Device type' as 'LW', 'Address' as '0', 'Address format' as 'dddd [range : 0 ~ 10255]', and 'Data count' as '4'. The 'BIN' dropdown is selected. The description is 'Read data from a device.', the usage is 'GetData(desti, PLC name, device type, address, data count)', and the example is 'char byData[10]'. 'OK' and 'Cancel' buttons are at the bottom.

API

Function name :

Variable 1

Variable type :

Variable : Array index :

Read address

PLC name :

Device type :

Address :

Address format :

Data count :

[Description]
Read data from a device.

[Usage]
GetData(desti, PLC name, device type, address, data count)

[Example]
char byData[10]

Step 4:

After the completion of a new macro, press 'Compile' button to compile the macro.

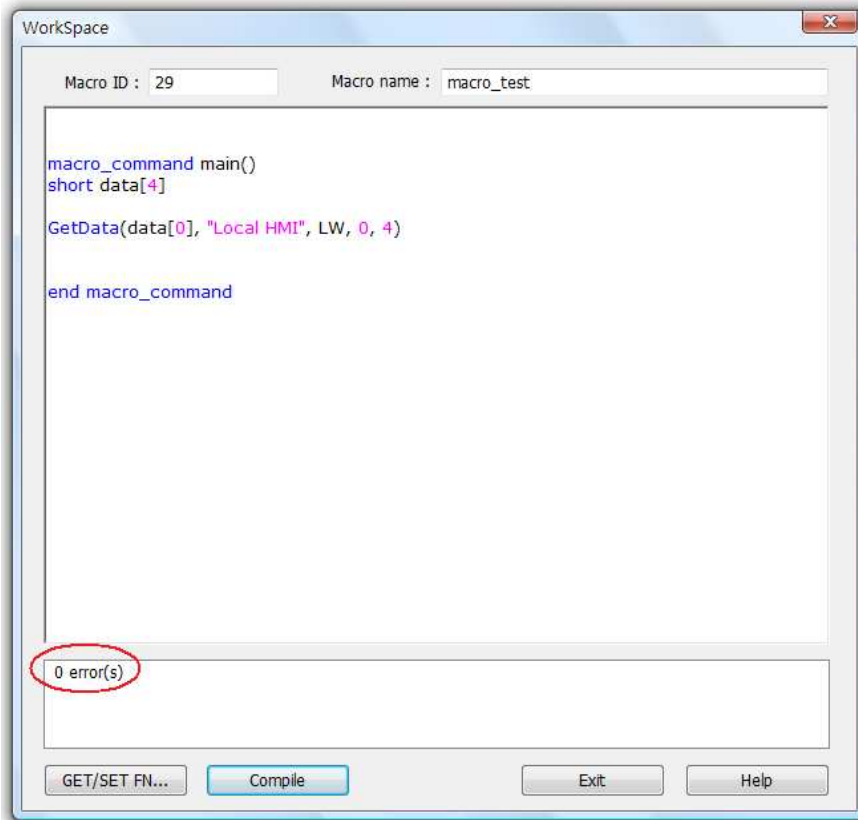

If there is no error, press “Exit” button and find that a new macro “macro_test” exists in “Macro list”.

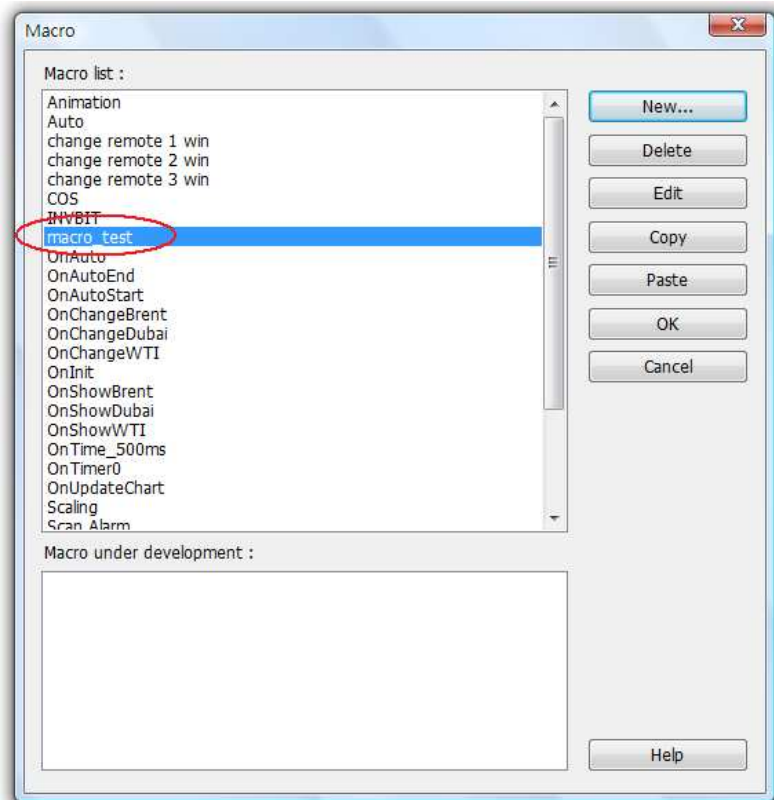

18.7.2 Execute a Macro

There are several ways to execute a macro.

- a. With a PLC Control object
 1. Open the PLC Control object and set the attribute to “Execute macro program”.
 2. Select the macro by name. Choose a bit and select a trigger condition to trigger the macro. The macro will continue to be re-triggered as long as the condition is met. In order to guarantee that the macro will run only once, consider latching the trigger bit, and then resetting the trigger condition within the macro.
 3. Use a [Set Bit](#) or [Toggle Switch](#) object to activate the bit.

- b. With a Set Bit or Toggle Switch object
 1. On the General tab of the Set Bit or Toggle Switch dialog, select the “Execute Macro” option.
 2. Select the macro to execute. The macro will execute one time when the button is activated.

- c. With a Function Key object
 1. On the General tab of the Set Bit or Toggle Switch dialog, select the Execute Macro option.
 2. Select the macro to execute. The macro will execute one time when the button is activated.

18.8 User Defined Macro Function

When editing Macro, to save time of defining functions, user may search for the needed from built-in Macro Function Library. However, certain functions, though frequently used, may not be found there. In this case, user may define the needed function and save it for future use. Next time when the same function is required, the saved functions can be called from Macro Function Library for easier editing. Additionally, Macro Function Library greatly enhances the portability of user-defined functions. Before building a function please check the built-in functions or online function library to see if it exists.

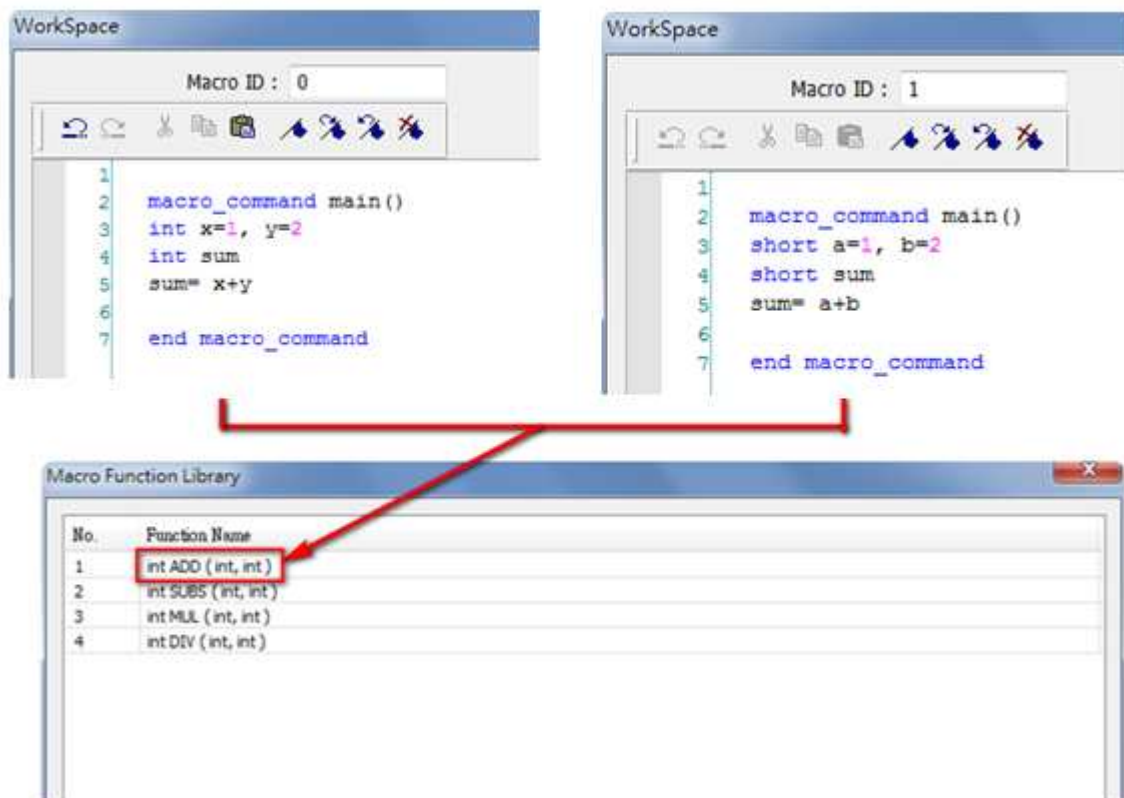

18.8.1 Import Function Library File

Open a project in HMI programming software, the default Function Library File will be read automatically and the function information will be loaded in. At this moment if a user-defined function is called, the relevant *.mlb file must be imported first.

1. Default Function Library File Name: MacroLibrary (without filename extension)
2. Function Library Directory: HMI programming software installation directory\library (folder)
3. \library (folder) contains two types of function library files:
 - Without filename extension: MacroLibrary, the Default Function Library for HMI programming software to read at the beginning.
 - With filename extension (*.mlb): Such as "math.mlb". The files to be read / written when users import / export. These files are portable and can be called from the folder when needed.
4. When opening HMI programming software, only the functions in Default Function Library will be loaded in, to use functions in *.mlb files, please import them first.

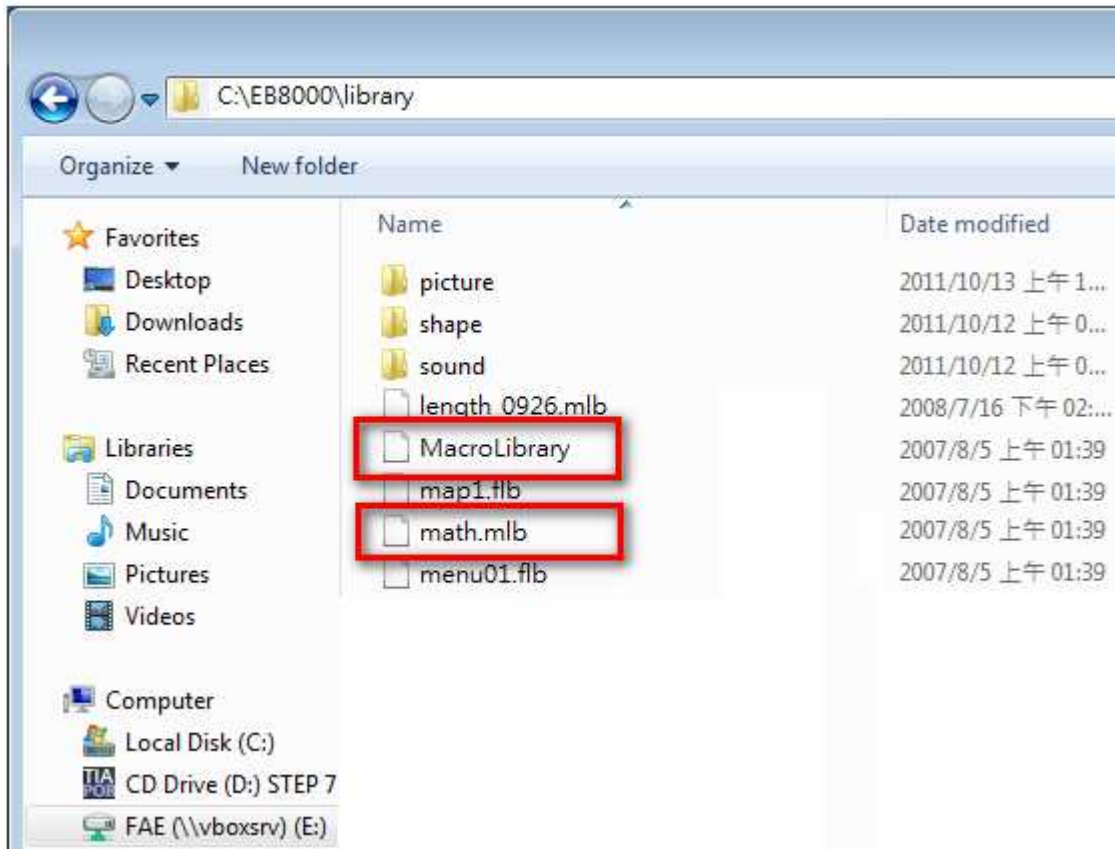

18.8.2 How to Use Macro Function Library

1. Select the function directly from Macro Function Library.
2. In WorkSpace click [GET/SET FN...] to open API dialog box.
3. At least check one from [Library] or [Build-in] and select the function to be used.
4. The description displayed in API dialog is the same as written in Function Editor.

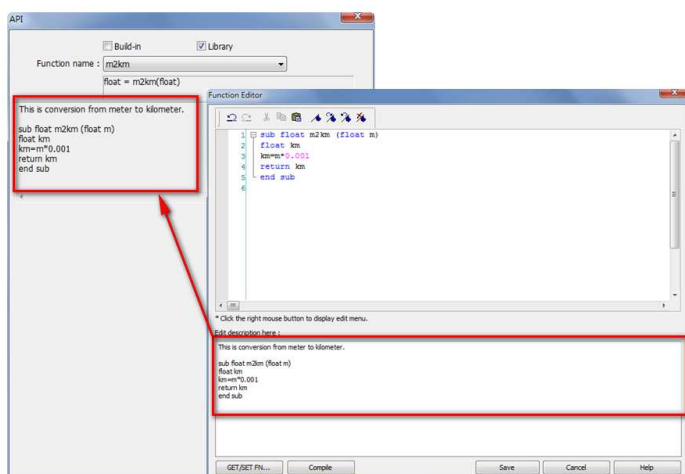
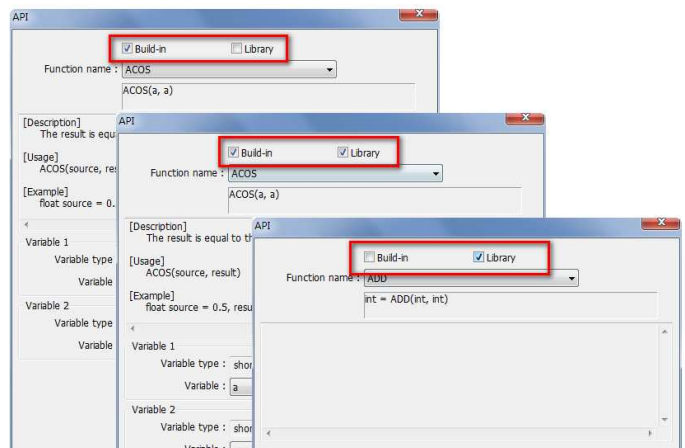
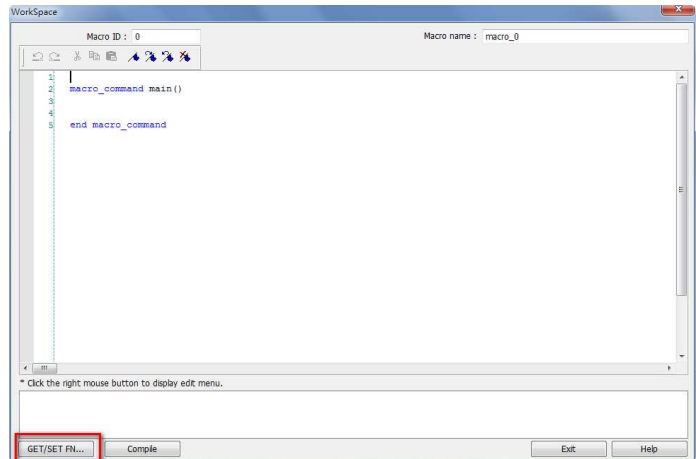
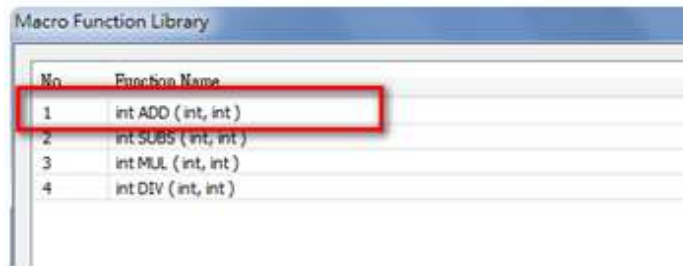

5. Select the function to be used, fill in the corresponding variables according to the data type.

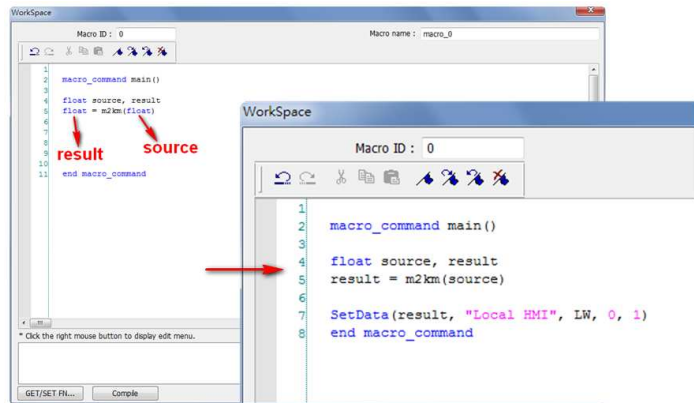

Upon completion of the steps above, user-defined functions can be used freely without defining the same functions repeatedly.

18.8.3 Function Library Management Interface

- 1 Open Macro management dialog, click [Library] to enter Macro Function Library interface.

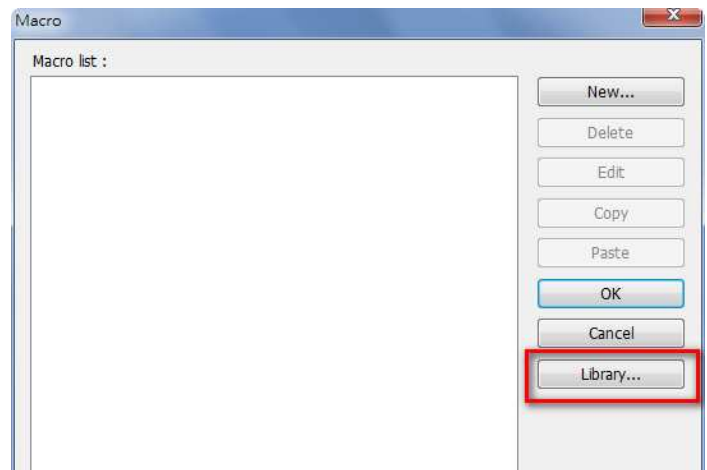

- 2 A list of functions will be shown, when the project is opened, the software will load in all the functions in the Default Function Library.

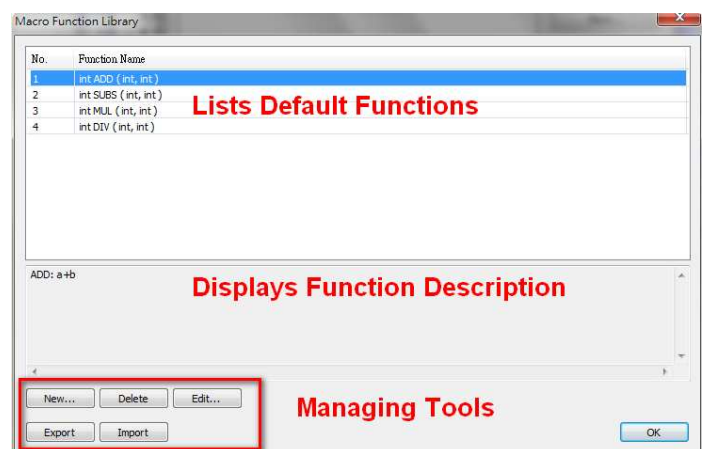

3. The format of each line in function list:

```
return_type function_name ( parameter_type1, ..., parameter_typeN)
```

return_type indicates the type of the return value. If this value does not exist, this column will be omitted. *function_name* indicates the name of the function. "N" in *parameter_typeN* stands for the number of parameter types. If this function does not accept any parameters, this column will be omitted.

```

1  sub int ADD(int a, int b)
2    int ret
3    ret = a+b
4    return ret
5  end sub
6

```

18.8.3.1 Create a Function

1. Click [New] to enter Function Editor.

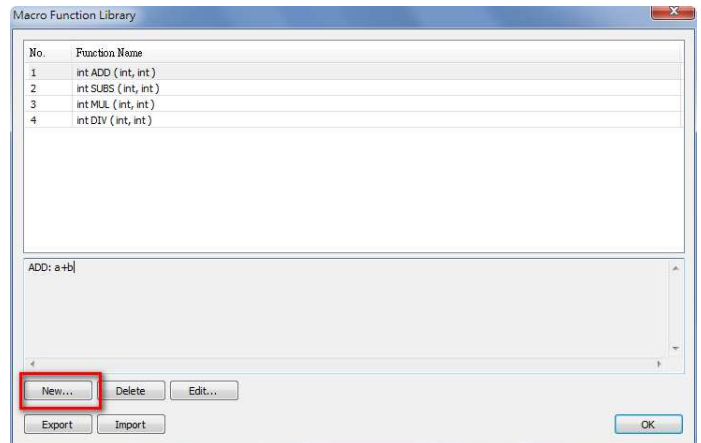

2. Edit function in Function Editing Field.

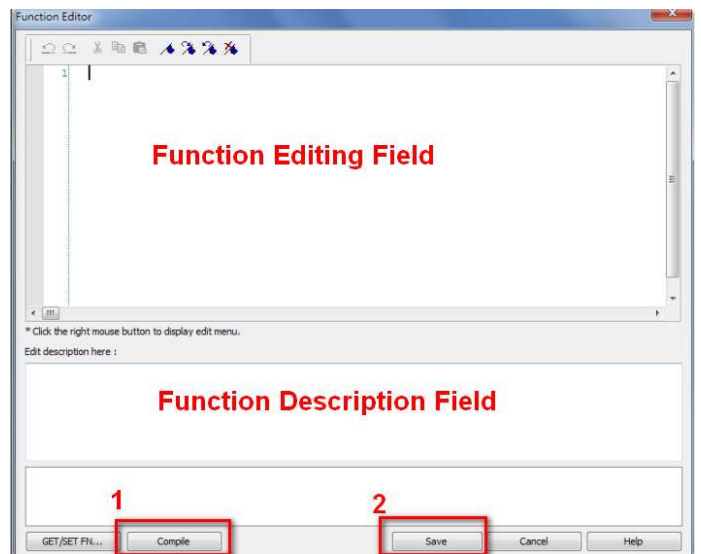

3. Edit function description here: specifications, usages, editor's statement etc.

4. After editing a function, click [Compile] and [Save] to save this function to the Library. If it is not compiled, a warning dialog will be shown.



5. Successfully added into Macro Function Library.

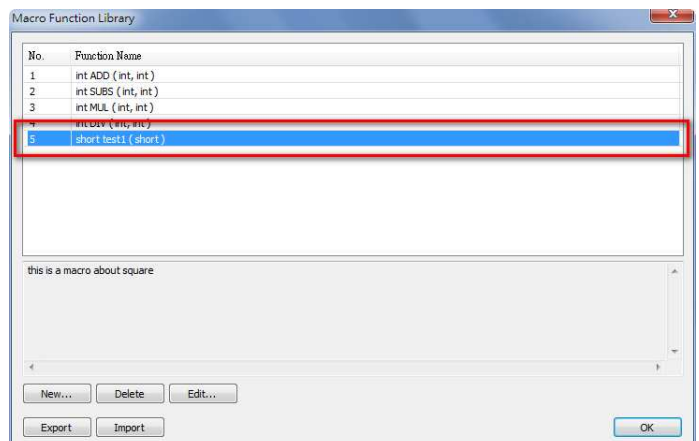



1. The total size of data type can be declared in a function is 4096 bytes.
 2. Function name must only contain alphanumeric characters, and cannot start with a number.
-

18.8.3.2 Delete a Function

1. In function list select the function to be deleted and click [Delete].
2. Click [Yes] to confirm, [No] to cancel the deletion.
3. Click [Yes] to delete MAX_SHORT function.

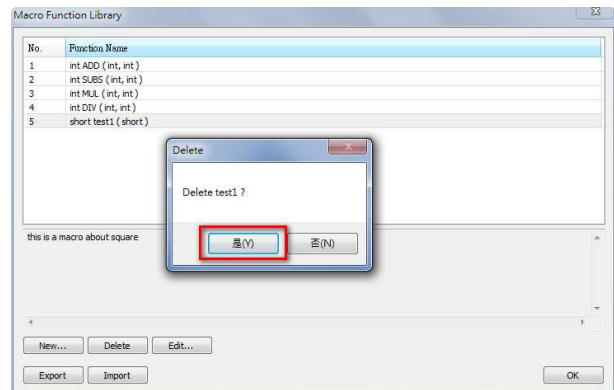
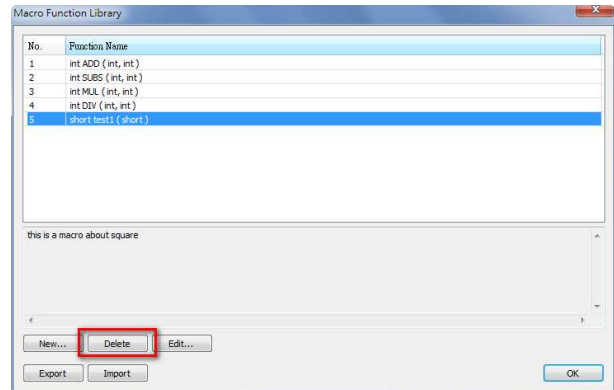

18.8.3.3 Modify a Function

1. Users can modify the functions exist in the Library.
2. Select a function to modify by clicking [Edit] to enter Function Editor
3. Double click on the function to be modified can also enter Function Editor.
4. After modifying, [Compile] then [Save] before leaving.

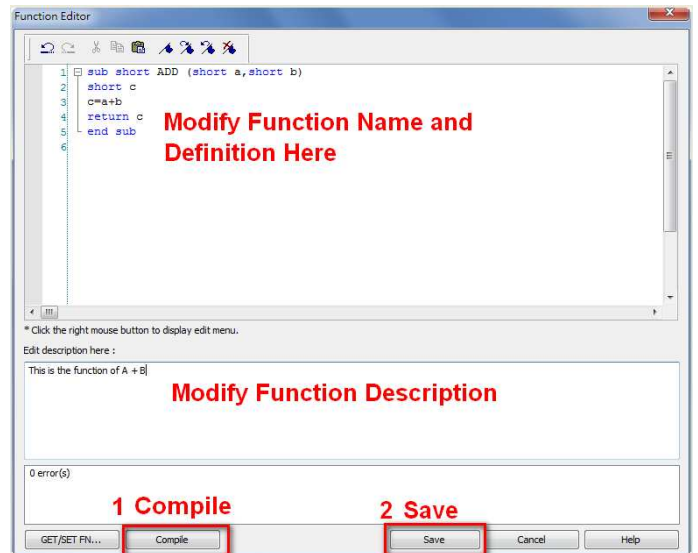
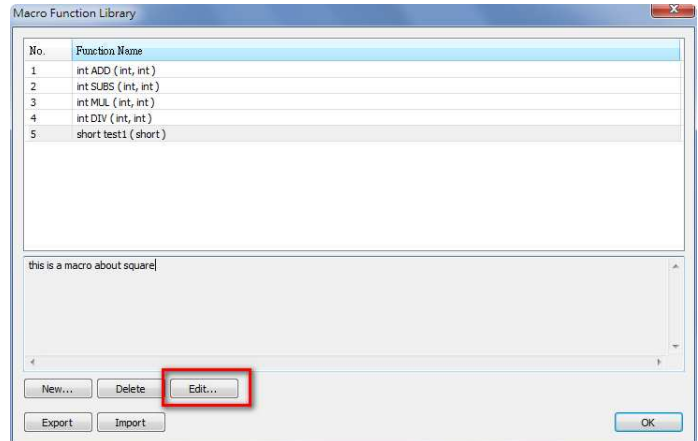

18.8.3.4 Import a Function

1. Functions can be imported using an external *.mlb file.

2. EX: To import a function library “math.mlb” which contains a function “test1”.
3. Click [Open].

4. When importing a function with a name which already exists in the Library, a message will popup.
 - OK: Overwrite the existing function with the imported one.
 - NO: Cancel the importing of the function with the same name.
 - Yes to all: Overwrite using all the imported functions with the same name.
 - No to all: Cancel the importing of all the functions with the same name.
5. The imported functions will be saved in Default Function Library, so if “math.mlb” file is deleted, “test1” will still exist in the Library, even when restart software.

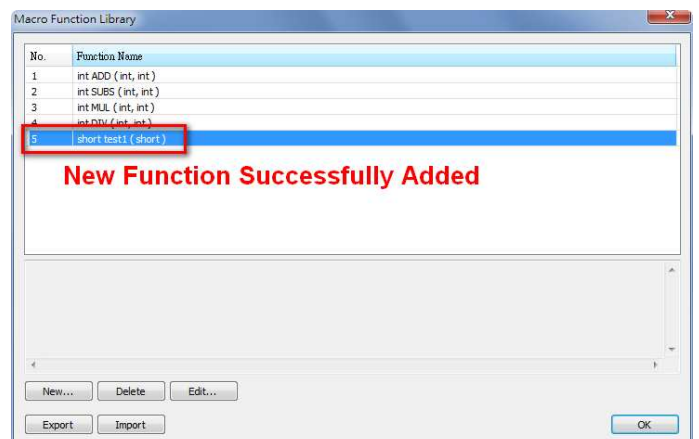
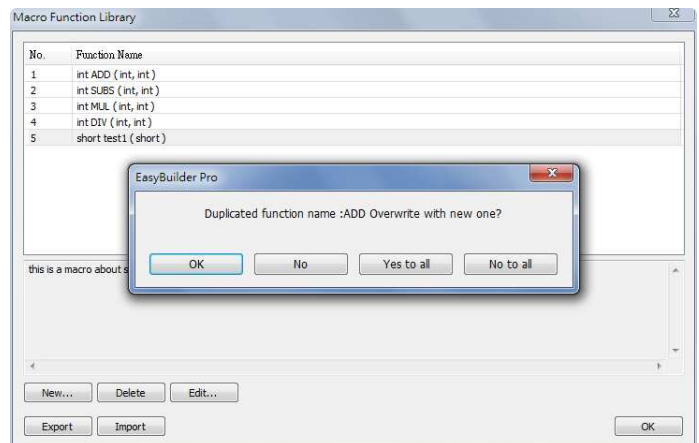
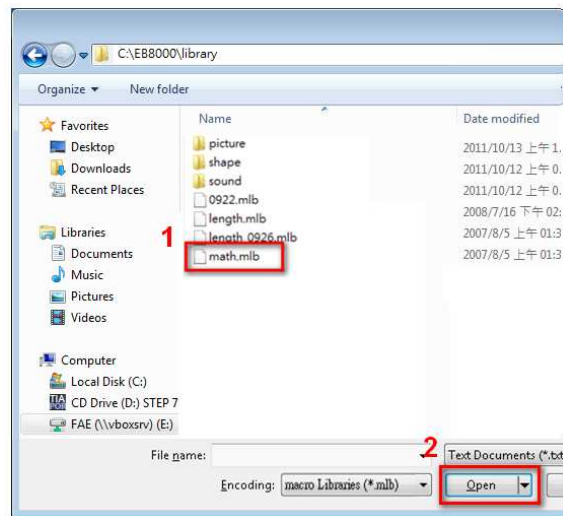
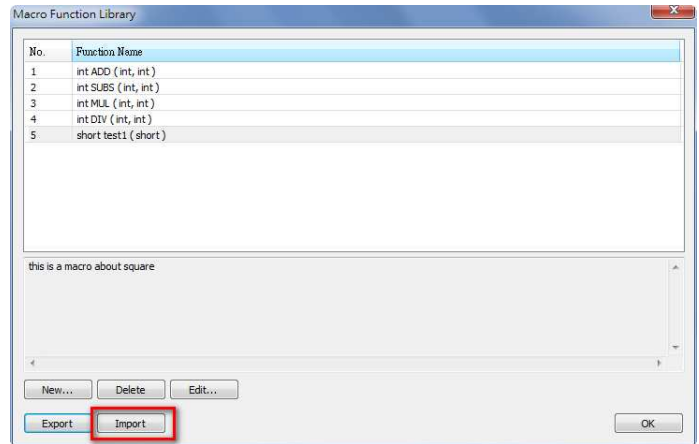

18.8.3.5 Export a Function

1. Export the function from Function Library and save as *.mlb file.
2. Click [Export].

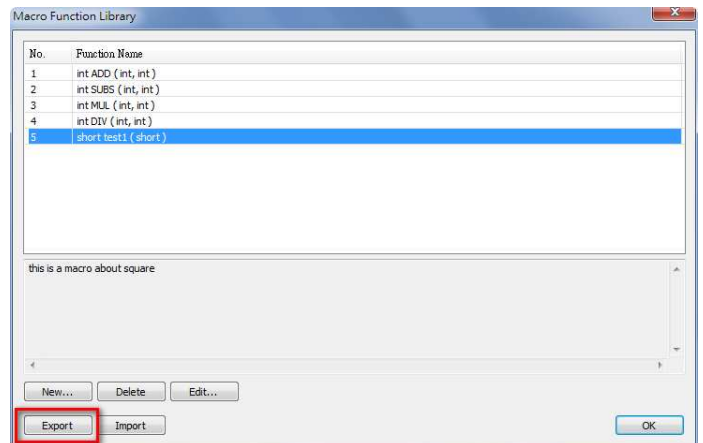

3. Select the function to be exported, and click [Export].
4. A “math.mlb” file can be found under export directory. This file contains 4 functions: ADD, SUBS, MUL, and DIV.

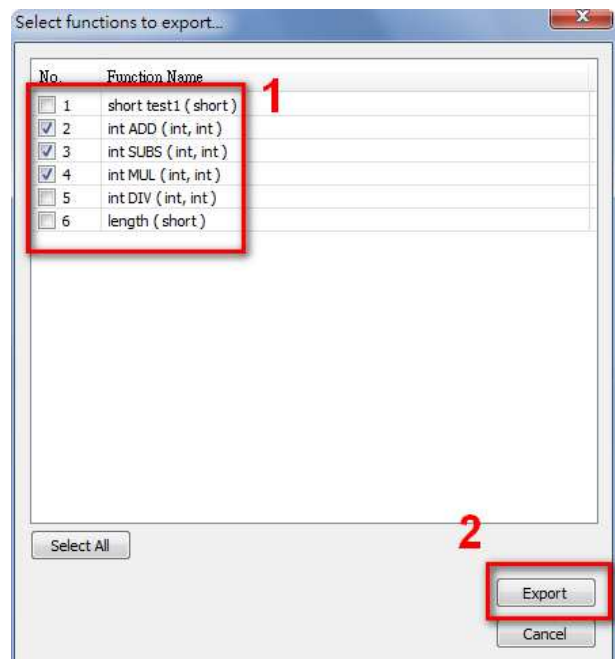

5. The exported *.mlb file can be imported to another PC. Open HMI programming software, import, then the functions in this file can be used.

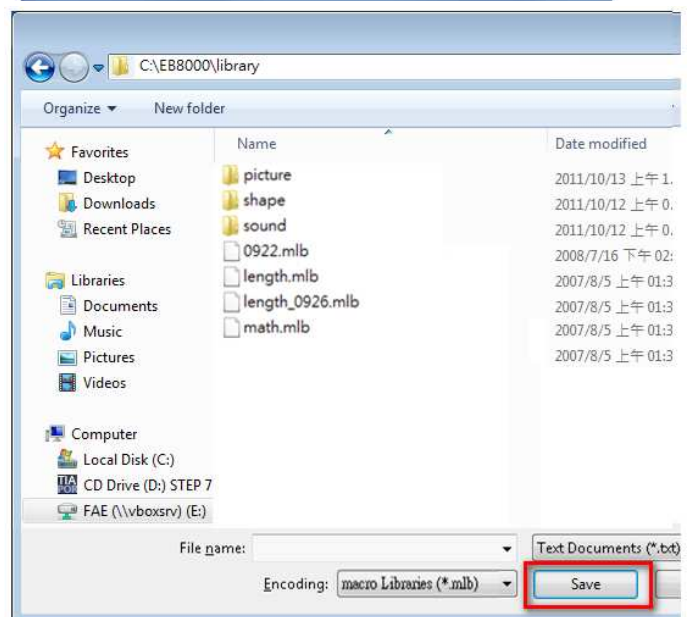

18.9 Some Notes about Using the Macro

1. The maximum storage space of local variables in a macro is 4K bytes. So the maximum array size of different variable types are as follows:

chara[4096]

boolb[4096]

short c[2048]

int d[1024]

float e[1024]

2. A maximum of 256 macros are allowed in an EasyBuilder 8000 project.
3. A macro may cause the HMI to lock up. Possible causes are:
 - . A macro contains an infinite loop with no PLC communication.
 - . The size of an array exceeds the storage space in a macro.
4. PLC communication time may cause the macro to execute slower than expected. Also, too many macro instructions may slow down the PLC communication.

18.10 Use the Free Protocol to Control a Device

When EasyBuilder 8000 does not provide an essential driver for communication with a device, Users also can make use of OUTPORT and INPORT to control the device. The data sent with OUTPORT and INPORT must follow the device's communication protocol. The following example explains how to use these two functions to control a MODBUS RTU device.

First, create a new device in the device table. The device type of the new device is set to "Free Protocol" and named with "MODBUS RTU device" as follows:

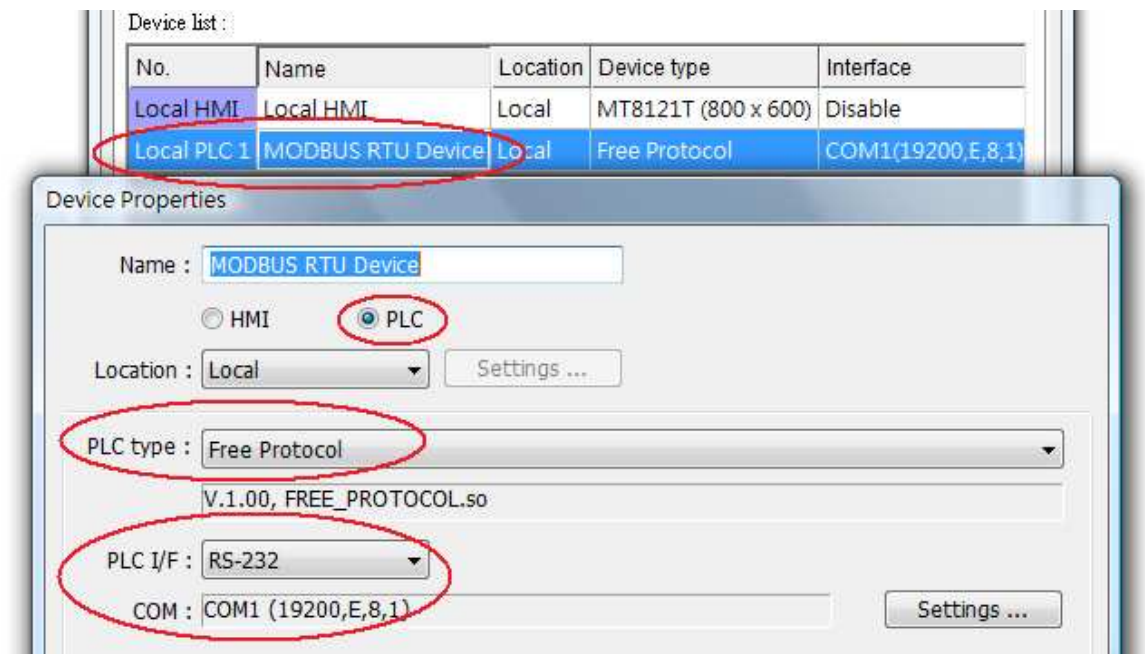

The interface of the device (PLC I/F) uses "RS-232" now. If connecting a MODBUS TCP/IP device, the interface must select 'Ethernet'. In addition, it is necessary to set correct IP and port number as follows:

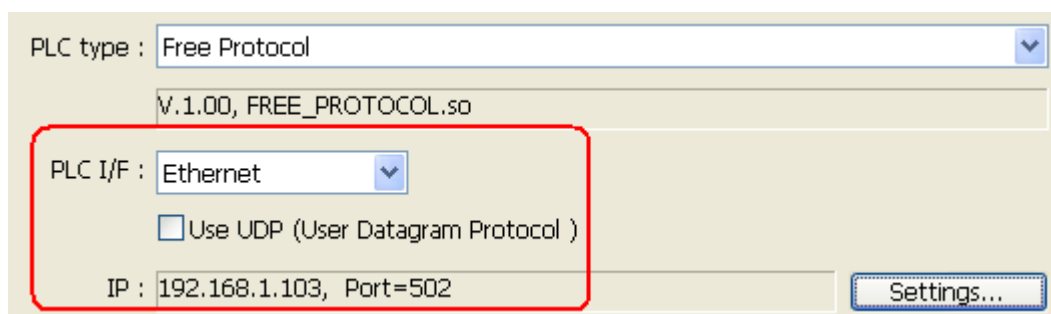

Suppose that HMI will read the data of 4x_1 and 4x_2 on the device. First, utilize OUTPORT to send out a read request to the device. The prototype of OUTPORT is:

```
OUTPORT(command[start], device_name, cmd_count)
```

Since “MODBUS RTU device” is a MODBUS RTU device, the read request must follow MODBUS RTU protocol. The request uses “Reading Holding Registers (0x03)” command to read data. The following picture displays the content of the command. (The items of the station number (byte 0) and the last two bytes (CRC) are ignored).

Request

Function code	1 Byte	0x03
Starting Address	2 Bytes	0x0000 to 0xFFFF
Quantity of Registers	2 Bytes	1 to 125 (0x7D)

Response

Function code	1 Byte	0x03
Byte count	1 Byte	2 x N*
Register value	N* x 2 Bytes	

*N = Quantity of Registers

Error

Error code	1 Byte	0x83
Exception code	1 Byte	01 or 02 or 03 or 04

Depending on the protocol, the content of a read command as follows (The total is 8 bytes):

command[0] : station number	(BYTE 0)
command[1] : function code	(BYTE 1)
command[2] : high byte of starting address	(BYTE 2)
command[3] : low byte of starting address	(BYTE 3)
command[4] : high byte of quantity of registers	(BYTE 4)
command[5] : low byte of quantity of registers	(BYTE 5)
command[6] : low byte of 16-bit CRC	(BYTE 6)
command[7] : high byte of 16-bit CRC	(BYTE 7)

So a read request is designed as follows :

```
char command[32]
short address, checksum
```

```
FILL(command[0], 0, 32) // initialize command[0]~command[31] to 0
```

```
command[0] = 0x1 // station number
```

```
command[1] = 0x3 // read holding registers (function code is 0x3)
```

```
address = 0// starting address (4x_1) is 0
```

```
HIBYTE(address, command[2])
```

```
LOBYTE(address, command[3])
```

```
read_no = 2// the total words of reading is 2 words
```

```
HIBYTE(read_no, command[4])
```

```
LOBYTE(read_no, command[5])
```

```
CRC(command[0], checksum, 6)// calculate 16-bit CRC
```

```
LOBYTE(checksum, command[6])
```

```
HIBYTE(checksum, command[7])
```

Lastly, use OUPORT to send out this read request to PLC

```
OUTPORT(command[0], "MODBUS RTU Device", 8)// send read request
```

After sending out the request, use INPORT to get the response from PLC.

Depending on the protocol, the content of the response is as follows (the total byte is 9):

command[0] : station number	(BYTE 0)
command[1] : function code	(BYTE 1)
command[2] : byte count	(BYTE 2)
command[3] : high byte of 4x_1	(BYTE 3)
command[4] : low byte of 4x_1	(BYTE 4)
command[5] : high byte of 4x_2	(BYTE 5)
command[6] : high byte of 4x_2	(BYTE 6)
command[7] : low byte of 16-bit CRC	(BYTE 7)
command[8] : high byte of 16-bit CRC	(BYTE 8)

The usage of INPORT is described below:

```
INPORT(response[0], "MODBUS RTU Device", 9, return_value)// read
response
```

Where the real read count is restored to the variable `return_value` (unit is byte).
If `return_value` is 0, it means reading fails in executing `INPORT`.

Depending on the protocol, `response[1]` must be equal to `0x3`, if the response is correct. After getting correct response, calculate the data of `4x_1` and `4x_2` and put in the data into `LW100` and `LW101` of HMI.

```
if (return_value >0 and response[1] == 0x3) then
    read_data[0] = response[4] + (response[3] << 8)// 4x_1
    read_data[1] = response[6] + (response[5] << 8)// 4x_2

    SetData(read_data[0], "Local HMI", LW, 100, 2)
end if
```

The complete macro is as follows:

```
// Read Holding Registers
macro_command main()

char command[32], response[32]
short address, checksum
short read_no, return_value, read_data[2], i

FILL(command[0], 0, 32)// initialize command[0]~command[31] to 0
FILL(response[0], 0, 32)

command[0] = 0x1// station number
command[1] = 0x3// read holding registers (function code is 0x3)

address = 0
address = 0// starting address (4x_1) is 0
HIBYTE(address, command[2])
LOBYTE(address, command[3])

read_no = 2/ the total words of reading is 2 words
HIBYTE(read_no, command[4])
```

```

LOBYTE(read_no, command[5])

CRC(command[0], checksum, 6)// calculate 16-bit CRC

LOBYTE(checksum, command[6])
HIBYTE(checksum, command[7])

OUTPORT(command[0], "MODBUS RTU Device", 8 )// send request
INPORT(response[0], "MODBUS RTU Device", 9, return_value)// read
response

if (return_value > 0 and response[1] == 0x3) then
    read_data[0] = response[4] + (response[3] << 8)// 4x_1
    read_data[1] = response[6] + (response[5] << 8)// 4x_2

    SetData(read_data[0], "Local HMI", LW, 100, 2)
end if

end macro_command
    
```

The following example explains how to design a request to set the status of 0x_1. The request uses "Write Single Coil(0x5)" command.

Request

Function code	1 Byte	0x05
Output Address	2 Bytes	0x0000 to 0xFFFF
Output Value	2 Bytes	0x0000 or 0xFF00

Response

Function code	1 Byte	0x05
Output Address	2 Bytes	0x0000 to 0xFFFF
Output Value	2 Bytes	0x0000 or 0xFF00

Error

Error code	1 Byte	0x85
Exception code	1 Byte	01 or 02 or 03 or 04

The complete macro is as follows:

```

// Write Single Coil (ON)
macro_command main()
    
```

```
char command[32], response[32]
short address, checksum
short i, return_value

FILL(command[0], 0, 32)// initialize command[0]~ command[31] to 0
FILL(response[0], 0, 32)

command[0] = 0x1// station number
command[1] = 0x5// function code : write single coil

address = 0
HIBYTE(address, command[2])
LOBYTE(address, command[3])

command[4] = 0xff// force 0x_1 on
command[5] = 0

CRC(command[0], checksum, 6)

LOBYTE(checksum, command[6])
HIBYTE(checksum, command[7])

OUTPORT(command[0], "MODBUS RTU Device", 8)// send request
INPORT(response[0], "MODBUS RTU Device", 8, return_value)// read
response

end macro_command
```

18.11 Compiler Error Message

1. Error Message Format:

error c# : error description

(# is the error message number)

Example: error C37 : undeclared identifier : i

When there are compile errors, the error description can be referenced by the compiler error message number.

2. Error Description

(C1)syntax error : 'identifier'

There are many possibilities to cause compiler error.

For example:

```
macro_command main()
char i, 123xyz // this is an unsupported variable name
end macro_command
```

(C2) 'identifier' used without having been initialized

Macro must define the size of an array during declaration.

For example:

```
macro_command main()
char i
int g[i] // i must be a numeric constant
end macro_command
```

(C3) redefinition error : 'identifier'

The name of variable and function within its scope must be unique.

For example:

```
macro_command main()

int g[10] , g // error
```

end macro_command

(C4) function name error : 'identifier'

Reserved keywords and constant can not be the name of a function

For example :

```
sub int if() // error
```

(C5) parentheses have not come in pairs

Statement missing "(" or ")"

For example :

```
macro_command main ) // missing "("
```

(C6) illegal expression without matching 'if'

Missing expression in "if" statement

(C7) illegal expression (no 'then') without matching 'if'

Missing "then" in "if" statement

(C8) illegal expression (no 'end if')

Missing "end if"

(C9) illegal 'end if' without matching 'if'

Unfinished "If" statement before "End If"

(C10) illegal 'else'

The format of "if" statement is :

```
if [logic expression] then
[ else [if [logic expression] then ] ]
```

```
end if
```

Any format other than this format will cause a compile error.

(C17) illegal expression (no 'for') without matching 'next'

“for” statement error : missing “for” before “next”

(C18) illegal variable type (not integer or char)

Should be integer or char variable

(C19) variable type error

Missing assign statement

(C20) must be keyword ‘to’ or ‘down’

Missing keyword “to” or “down”

(C21) illegal expression (no 'next')

The format of “for” statement is:

for [variable] = [initial value] to [end value] [step]

next [variable]

Any format other than this format will cause a compile error.

(C22) ‘wend’ statement contains no ‘while’

“While” statement error : missing “while” before “Wend”

(C23) illegal expression without matching ‘wend’

The format of “While” statement is :

while [logic expression]

wend

Any format other than this format will cause a compile error.

(C24) syntax error : ‘break’

“break” statement can only be used in “for”, “while” statement.

(C25) syntax error : ‘continue’

“continue” statement can only be used in “for” statement, or “while” statement.

(C26) syntax error

Error in expression.

(C27) syntax error

The mismatch of an operation object in expression can cause a compile error.

For example :

```
macro_command main( )
int a, b
for a = 0 to 2
b = 4 + xyz // illegal : xyz is undefined
next a
end macro_command
```

(C28) must be 'macro_command'

There must be 'macro_command'

(C29) must be key word 'sub'

The format of function declaration is:

```
sub [data type] function_name(...)
.....
end sub
```

For example::

```
sub int pow(int exp)
.....
end sub
```

Any format other than this format will cause a compile error.

(C30) number of parameters is incorrect

Mismatch of the number of parameters

(C31) parameter type is incorrect

Mismatch of data type of parameter. When a function is called, the data type and the number of parameters should match the declaration of function, otherwise it will cause a compile error.

(C32) variable is incorrect

The parameters of a function must be equivalent to the arguments passing to a function to avoid compile error.

(C33) function name : undeclared function

(C34) expected constant expression

Illegal array index format.

(C35) invalid array declaration

(C36) array index error

(C37) undeclared identifier : i 'identifier'

Any variable or function should be declared before use.

(C38) un-supported PLC data address

The parameter of GetData(...), SetData(...) should be legal PLC address. If the address is illegal, this error message will be shown.

(C39) 'identifier' must be integer, char or constant

The format of array is:

Declaration: array_name[constant] (constant is the size of the array)

Usage: array_name[integer, character or constant]

Any format other than this format will cause a compile error.

(C40) execution syntax should not exist before variable declaration or constant definition

For example :

```
macro_command main( )  
int a, b  
for a = 0 To 2  
  b = 4 + a
```

```
int h , k // illegal – definitions must occur before any statements or
expressions
    // for example, b = 4 + a
next a
end macro_command
```

(C41) float variables cannot be contained in shift calculation

(C42) function must return a value

(C43) function should not return a value

(C44) float variables cannot be contained in calculation

(C45) PLC address error

(C46) array size overflow (max. 4k)

(C47) macro command entry function is not only one

(C48) macro command entry function must be only one

The only one main entrance of macro is :

```
macro_command function_name( )
end macro_command
```

(C49) an extended addressee's station number must be between 0 and 255

For example :

```
SetData(bits[0] , "PLC 1", LB , 300#123, 100)
// illegal : 300#123 means the station number is 300, but the
maximum is 255
```

(C50) an invalid PLC name

PLC name is not defined in the device list of system parameters.

(C51) macro command do not control a remote device

A macro can only control a local machine.

For example :

```
SetData(bits[0] , "PLC 1", LB , 300#123, 100)
```

"PLC 1" is connected with the remote HMI ,so it can not work.

18.12 Sample Macro Code

1. "for" statement and other expressions (arithmetic, bitwise shift, logic and comparison)

```
macro_command main()
int a[10], b[10], i

b[0]= (400 + 400 << 2) / 401
b[1]= 22 *2 - 30 % 7
b[2]= 111 >> 2
b[3]= 403 > 9 + 3 >= 9 + 3 < 4 + 3 <= 8 + 8 == 8
b[4]= not 8 + 1 and 2 + 1 or 0 + 1 xor 2
b[5]= 405 and 3 and not 0
b[6]= 8 & 4 + 4 & 4 + 8 | 4 + 8 ^ 4
b[7]= 6 - (~4)
b[8]= 0x11
b[9]= 409

for i = 0 to 4 step 1
    if (a[0] == 400) then
        GetData(a[0], "Device 1", 4x, 0,9)
        GetData(b[0], "Device 1", 4x, 11,10)
    end If
next i
end macro_command
```

2. "while", "if" and "break" statements

```
macro_command main()
int b[10], i
i = 5
while i == 5 - 20 % 3
    GetData(b[1], "Device 1", 4x, 11, 1)

    if b[1] == 100 then
        break
    end if
```

```
wend  
end macro_command
```

3. Global variables and function call

```
char g  
sub int fun(int j, int k)  
int y  
  
SetData(j, "Local HMI", LB, 14, 1)  
GetData(y, "Local HMI", LB, 15, 1)  
g = y  
  
return y  
end Sub  
  
macro_command main()  
int a, b, i  
  
a = 2  
b = 3  
i = fun(a, b)  
SetData(i, "Local HMI", LB, 16, 1)  
end macro_command
```

4. "if" statement

```
macro_command main()  
int k[10], j  
  
for j = 0 to 10  
    k[j] = j  
next j  
  
if k[0] == 0 then  
    SetData(k[1], "Device 1", 4x, 0, 1)  
end if
```

```
if k[0] == 0 then
    SetData(k[1], "Device 1", 4x, 0, 1)
else
    SetData(k[2], "Device 1", 4x, 0, 1)
end if
```

```
if k[0] == 0 then
    SetData(k[1], "Device 1", 4x, 1, 1)
else if k[2] == 1 then
    SetData(k[3], "Device 1", 4x, 2, 1)
end If
```

```
if k[0] == 0 then
    SetData(k[1], "Device 1", 4x, 3, 1)
else if k[2] == 2 then
    SetData(k[3], "Device 1", 4x, 4, 1)
else
    SetData(k[4], "Device 1", 4x, 5, 1)
end If
end macro_command
```

5. "while" and wend" statements

```
macro_command main()
char i = 0
int a[13], b[14], c = 4848
```

```
b[0] = 13
```

```
while b[0]
    a[i] = 20 + i * 10

    if a[i] == 120 then
        c = 200
        break
    end if

    i = i + 1
```

wend

```
SetData(c, "Device 1", 4x, 2, 1)
end macro_command
```

6. "break" and "continue" statements

```
macro_command main()
char i = 0
int a[13], b[14], c = 4848
```

```
b[0] = 13
```

```
while b[0]
    a[i] = 20 + i * 10

    if a[i] == 120 then
        c = 200
        i = i + 1
        continue
    end if

    i = i + 1

    if c == 200 then
        SetData(c, "Device 1", 4x, 2, 1)
        break
    end if
wend
end macro_command
```

7. Array

```
macro_command main()
int a[25], b[25], i

b[0] = 13
```



```
for i = 0 to b[0] step 1
  a[i] = 20 + i * 10
next i
```

```
SetData(a[0], "Device 1", 4x, 0, 13)
end macro_command
```

18.13 Macro TRACE Function

1. TRACE function is added to MACRO, and can be used with EasyDiagnoser, for viewing current content of the variable used.

The following illustrates how to use TRACE function in MACRO.

First of all, add macro_1 in the project, and in macro_1 add **TRACE** ("LW = %d", a). "%d" indicates to display current value of LW in decimal. The content of macro_1 is as the following:

```
macro_command main()

short a

GetData(a, "Local HMI", LW, 0, 1)

a= a + 1

SetData(a, "Local HMI", LW, 0, 1)

TRACE ("LW0 = %d", a)

end macro_command
```

For the detailed usage of TRACE function, please refer to the illustration in the following paragraph.

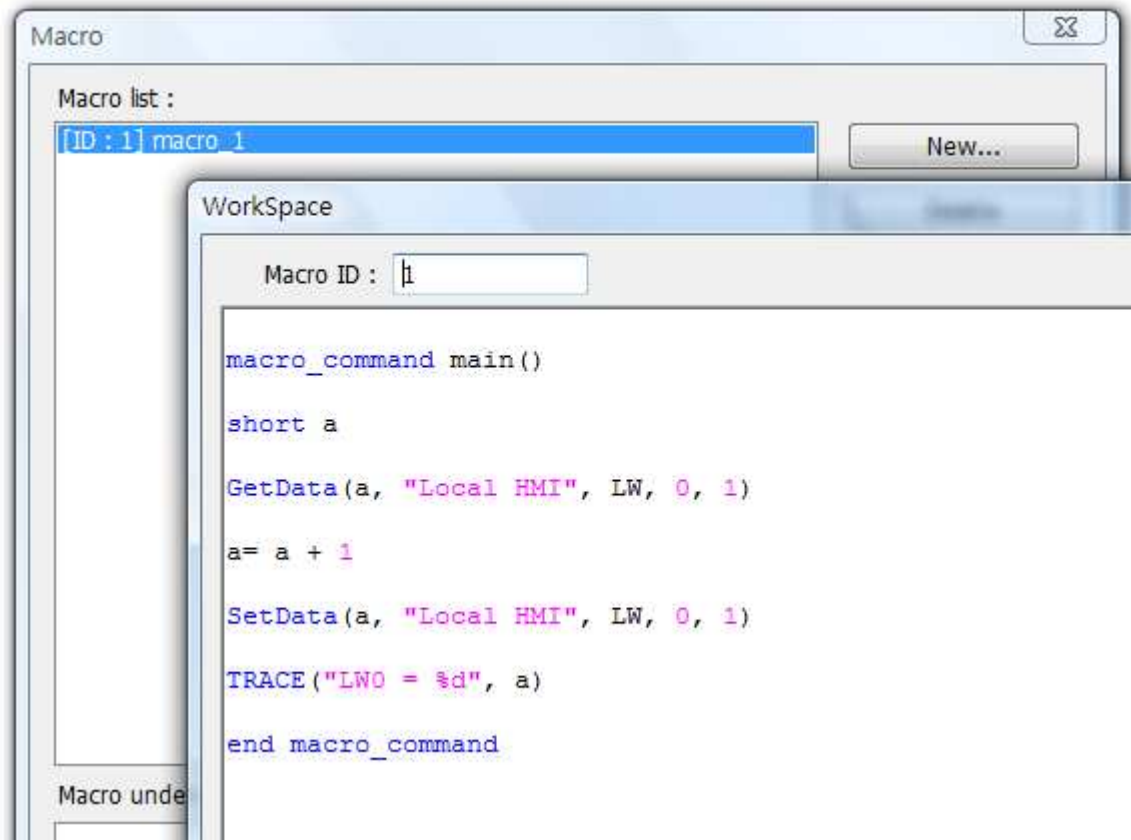

Secondly, add Numeric Display and Function Key objects in window 10 of the project. The settings of these objects are shown below. Function Key object is used to execute macro_1.

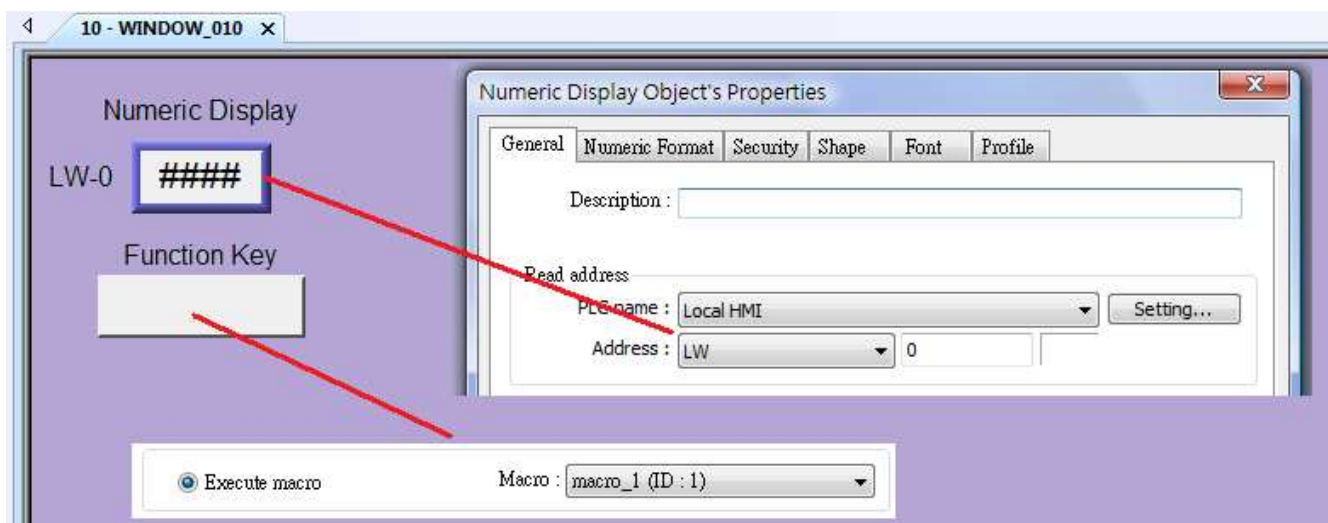

Lastly, compile the completed project and execute Off-line or On-line simulation.

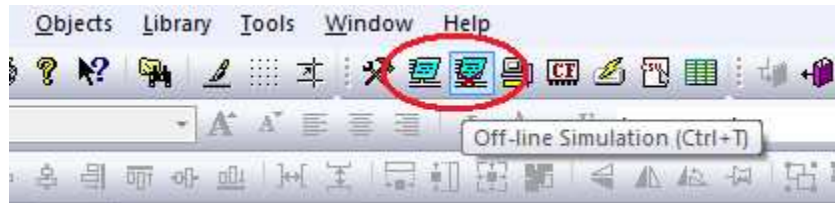

When processing simulation on PC, right click and select “Run EasyDiagnoser” in the pop-up menu.

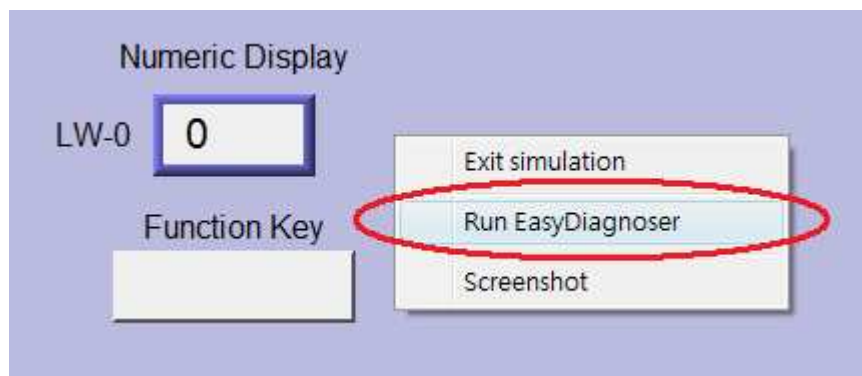

Afterwards, EasyDiagnoser will be started. [Logger] window displays whether EasyDiagnoser is able to connect with the HMI to be watched or not. [Output] window displays the output of the TRACE function. The illustration below shows that EasyDiagnoser succeeds in connecting with HMI.

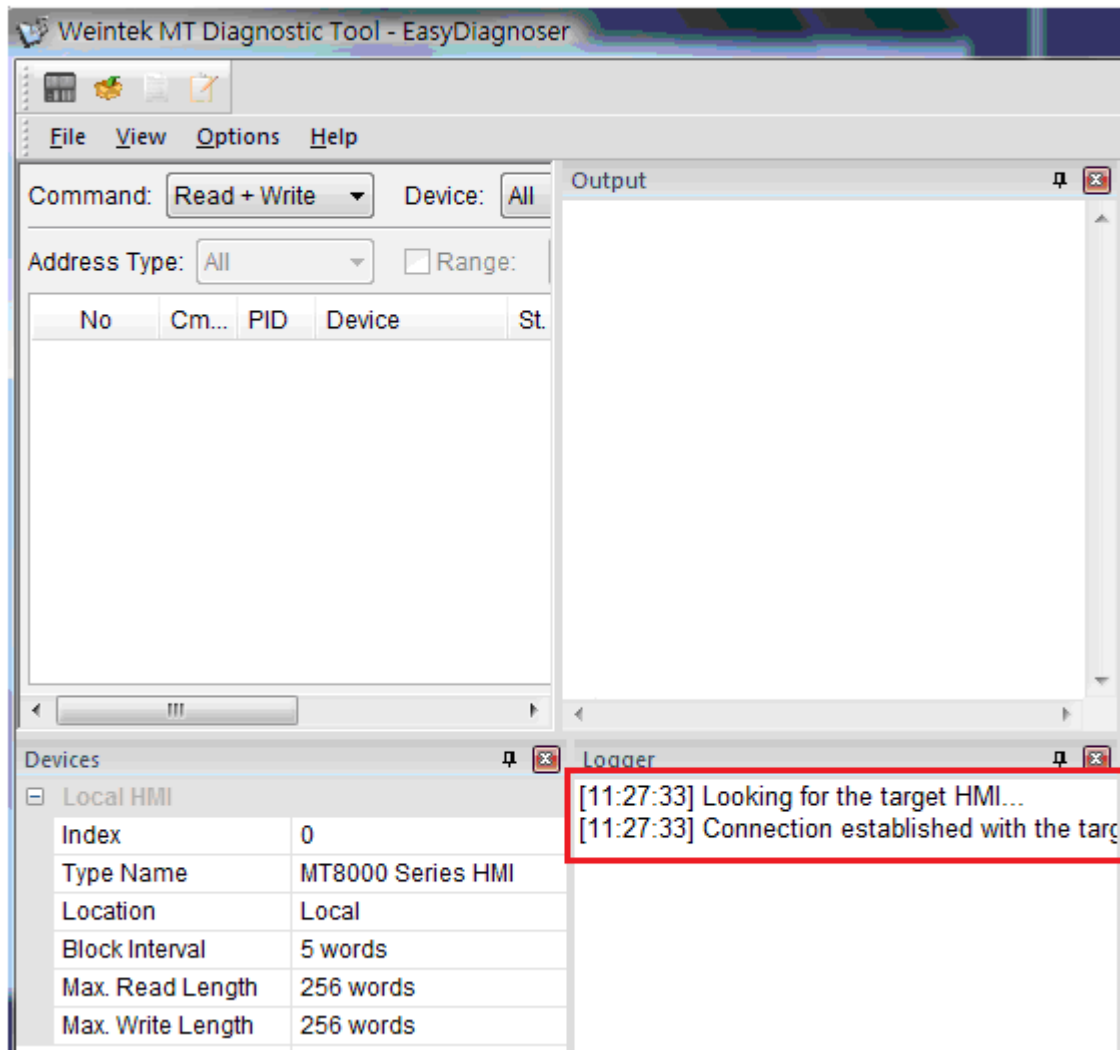

When EasyDiagnoser is not able to connect with HMI, [Logger] window displays content as shown below:

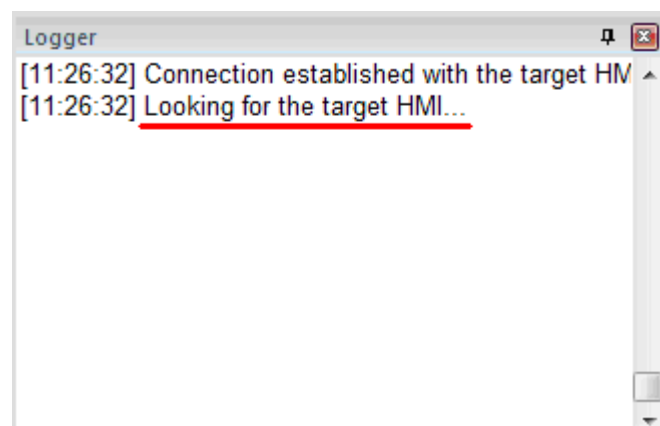

The possible reason of not being able to get connection with HMI can be failure in executing simulation on PC. Another reason is that the Port No. used in project for simulation on PC is incorrect (or occupied by system). Please change Port No. as shown, compile project then do simulation again.

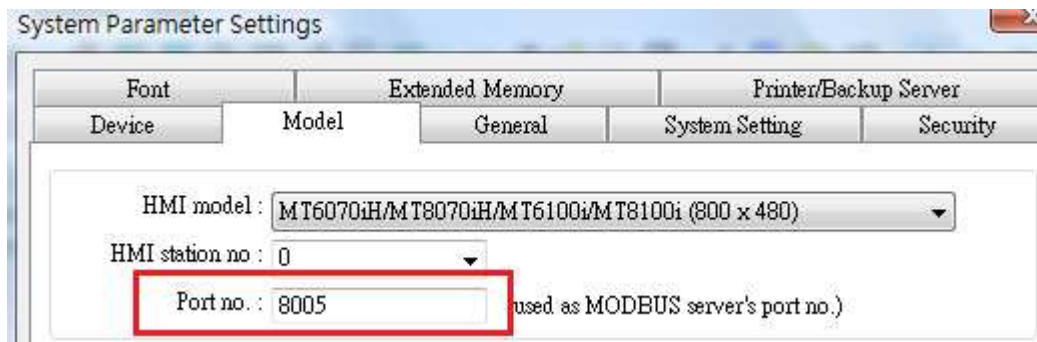

When opening EasyDiagnoser, the Port No. should be set the same as that in project. Only in this way can the communication succeed.

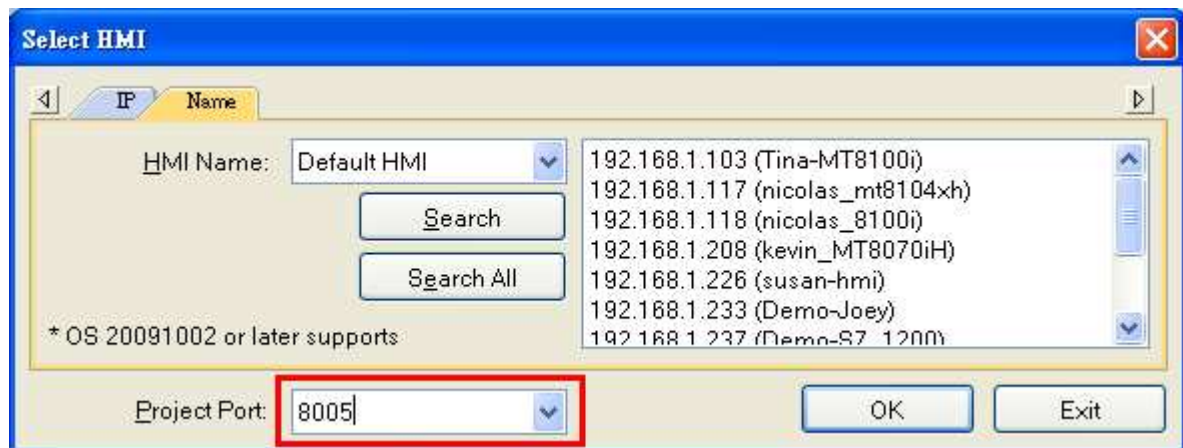

The three successive ports of the project port no. are preserved for HMI communication. Take the setting above as example, Port No. is set as 8005, therefore port 8005, 8006 and 8007 will be preserved. In this case when

executing simulation on PC, please make sure that these ports are not occupied by other programs.

2. TRACE Syntax List :

Name	TRACE														
Syntax	TRACE(format, argument)														
Description	<p>Use this function to send specified string to the EasyDiagnoser. Users can print out the current value of variables during run-time of macro for debugging.</p> <p>When TRACE encounters the first format specification (if any), it converts the value of the first argument after format and outputs it accordingly. <i>format</i> refers to the format control of output string. A format specification, which consists of optional (in []) and required fields (in bold), has the following form:</p> <p style="text-align: center;">%[flags] [width] [.precision] type</p> <p>Each field of the format specification is described as below:</p> <p><i>flags</i> (optional):</p> <p style="padding-left: 40px;">- +</p> <p><i>width</i> (optional):</p> <p style="padding-left: 40px;">A nonnegative decimal integer controlling the minimum number of characters printed.</p> <p><i>precision</i> (optional):</p> <p style="padding-left: 40px;">A nonnegative decimal integer which specifies the precision and the number of characters to be printed.</p> <p><i>type</i>:</p> <table style="margin-left: 40px;"> <tr> <td>C or c</td> <td>: specifies a single-byte character.</td> </tr> <tr> <td>d</td> <td>: signed decimal integer.</td> </tr> <tr> <td>i</td> <td>: signed decimal integer.</td> </tr> <tr> <td>o</td> <td>: unsigned octal integer.</td> </tr> <tr> <td>u</td> <td>: unsigned decimal integer.</td> </tr> <tr> <td>X or x</td> <td>: unsigned hexadecimal integer.</td> </tr> <tr> <td>E or e</td> <td>: Signed value having the form.</td> </tr> </table> <p style="margin-left: 40px;">[-]<i>d</i>.<i>dddd</i> e [<i>sign</i>]<i>ddd</i> where <i>d</i> is a single decimal digit, <i>dddd</i> is one or more decimal digits, <i>ddd</i> is exactly three decimal digits, and <i>sign</i> is + or -.</p>	C or c	: specifies a single-byte character.	d	: signed decimal integer.	i	: signed decimal integer.	o	: unsigned octal integer.	u	: unsigned decimal integer.	X or x	: unsigned hexadecimal integer.	E or e	: Signed value having the form.
C or c	: specifies a single-byte character.														
d	: signed decimal integer.														
i	: signed decimal integer.														
o	: unsigned octal integer.														
u	: unsigned decimal integer.														
X or x	: unsigned hexadecimal integer.														
E or e	: Signed value having the form.														

	<p style="text-align: center;">f : Signed value having the form [–]<i>dddd.dddd</i>, where <i>dddd</i> is one or more decimal digits.</p> <p>The length of output string is limited to 256 characters. The <i>argument</i> part is optional.</p>
<p>Example</p>	<pre>macro_command main() char c1 = 'a' short s1 = 32767 float f1 = 1.234567 TRACE("The results are") // output: The results are TRACE("c1 = %c, s1 = %d, f1 = %f", c1, s1, f1) // output: c1 = a, s1 = 32767, f1 = 1.234567 end macro_command</pre>

3. Newly Added LB9059 – disable MACRO TRACE function (when ON)

When set ON, the output message of TRACE won't be sent to EasyDiagnoser.

4. Users can directly execute EasyDiagnoser.exe from Project Manager. In Project Manager, current HMI on line will be listed; users can simply select the HMI to be watched.

Please note that Project Port should be the same as Port No. used in project file.

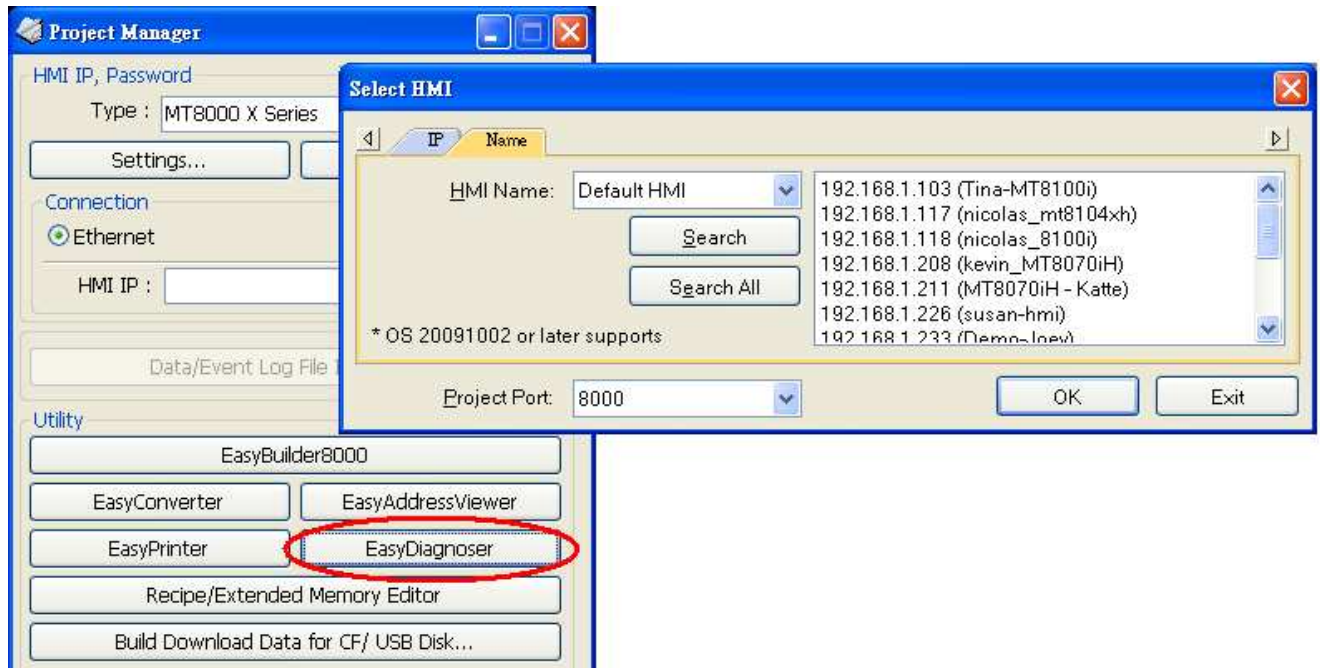

5. Download project to HMI to start operating. When EasyDiagnoser is unable to get connection with the HMI to be watched, it is possible that HMI power is not ON, or Port No. is incorrect. This may cause EasyDiagnoser to connect then disconnect with HMI continuously. Please check if the Port No. in EasyDiagnoser settings is same as that of the project. The way to change it is described before.
6. When EasyDiagnoser succeeds in connecting with HMI, simply execute macro_1, [Output] window will then display the output of the TRACE function.

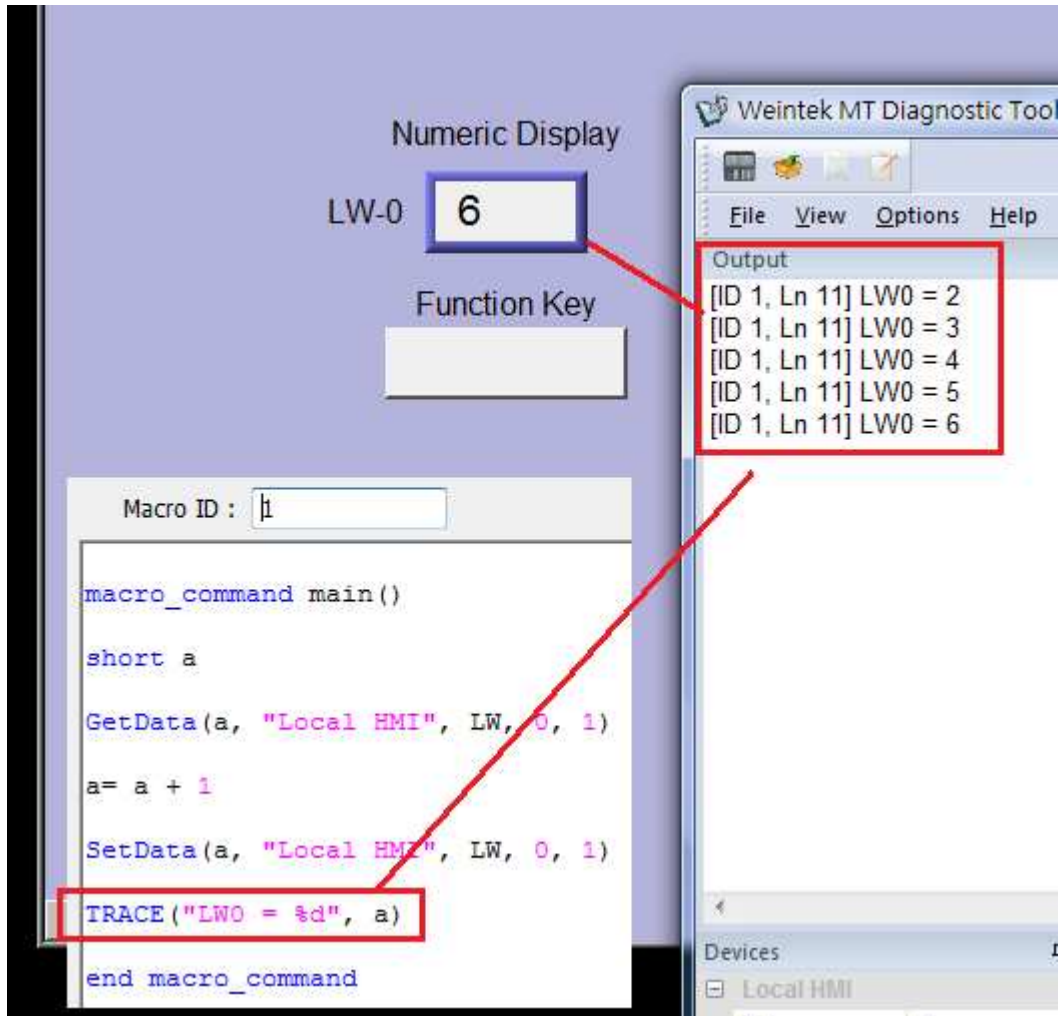

18.14 The Usage of String Operation Functions

String operation functions are added to macro which provides users a more convenient way to operate strings. The term “string” means a sequence of ASCII characters, each of which occupies 1 byte. The sequence of characters can be stored into 16-bit registers with least significant byte first. For example, create an ASCII input object and setup as follows:

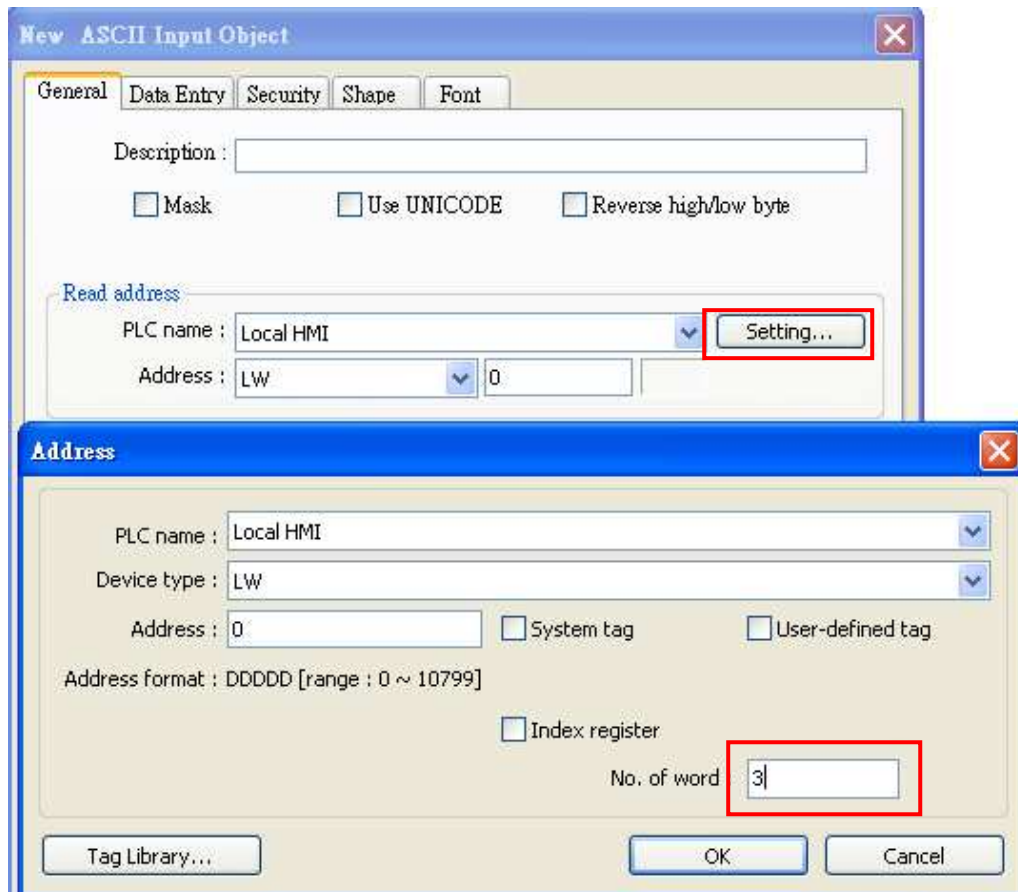

Run simulation and input “abcdef”:



The string “abcdef” is stored in LW0~LW2 as follows (LB represents low byte and HB represents high byte):

	HB	LB
LW0	'B'	'A'
LW1	'D'	'C'
LW2	'F'	'E'
LW3		
LW4		
LW5		

The ASCII input object reads 1 word (2 bytes) at a time as described in the previous chapter. Suppose an ASCII input object is set to read 3 words as shown in the above example, it can actually read at most 6 ASCII characters since that one ASCII character occupies 1 byte.

The functionality of each string operation function is described in the following table:

Function name	Description
StringGet	Read string data from a device.
StringGetEx	Read string data from a device and continue executing next command even if no response from that device.
StringSet	Write string data to a device.
StringSetEx	Write string data to a device and continue executing next command even if no response from that device.
StringCopy	Copy one string to another.
StringMid	Retrieve a substring.
StringDecAsc2Bin	Convert a decimal string to an integer.
StringBin2DecAsc	Convert an integer to a decimal string.
StringDecAsc2Float	Convert a decimal string to floats.
StringFloat2DecAsc	Convert a float to a decimal string.
StringHexAsc2Bin	Convert a hexadecimal string to binary data.
StringBin2HexAsc	Convert binary data into a hexadecimal string.
StringLength	Obtain the length of a string.
StringCat	Append source string to destination string.
StringCompare	Do a case-sensitive comparison of two strings.
StringCompareNoCase	Do a case-insensitive comparison of two strings.
StringFind	Find a substring inside a larger string.
StringReverseFind	Find a substring inside a larger string; starts from the end.
StringFindOneOf	Find the first matching character from a set.
StringIncluding	Extracts a substring that contains only the characters in a set.
StringExcluding	Extracts a substring that contains only the characters not in a set.
StringToUpper	Convert the characters of a string to uppercase.
StringToLower	Convert the characters of a string to lowercase.
StringToReverse	Reverse the characters of a string.
StringTrimLeft	Trim the leading specified characters in a set from

	the source string.
StringTrimRight	Trim the trailing specified characters in a set from the source string.
StringInsert	Insert a string in a specific location within another string.

For more detailed information of the above string operation functions, please check out the “Build-In Function Block” section. In order to demonstrate the powerful usage of string operation functions, the following examples will show you step by step how to create executable project files using the new functions; starts from creating a macro, ends in executing simulation.

1. How to read (or write) a string from a device.



Create a new macro:

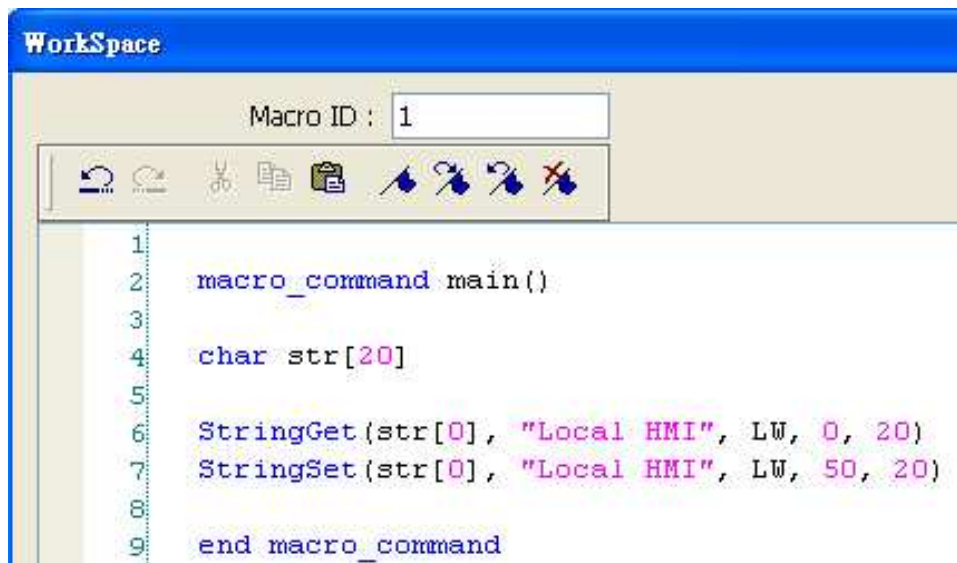

Edit the content:



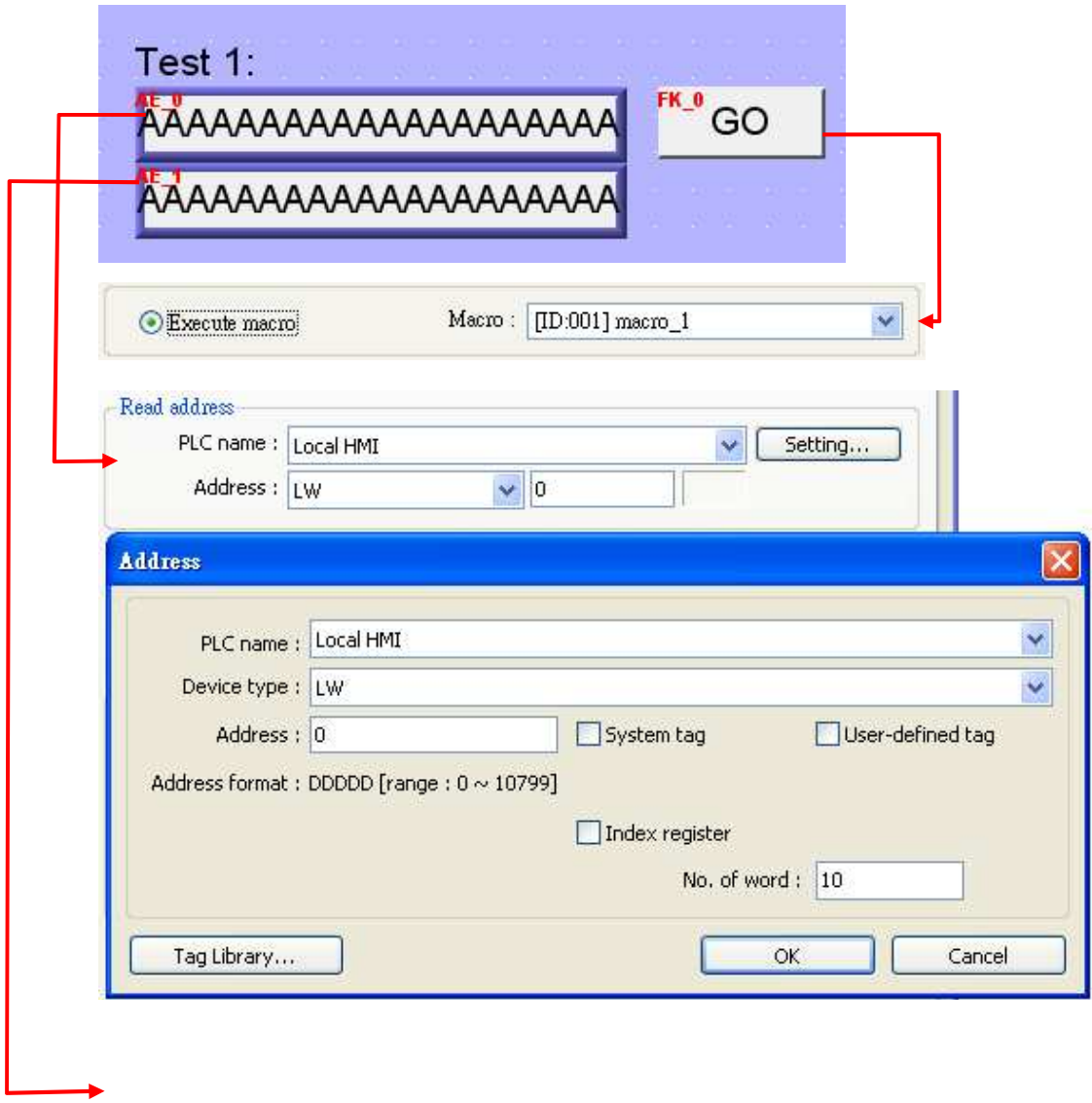

The first function “StringGet” is used to read a string from LW0~LW19, and store it into the str array. The second function “StringSet” is used to output the content of str array.

Add ASCII Input  and Function Key  objects in window 10 of the project. The settings of these objects are shown as below. Function Key object is used to execute macro_1.

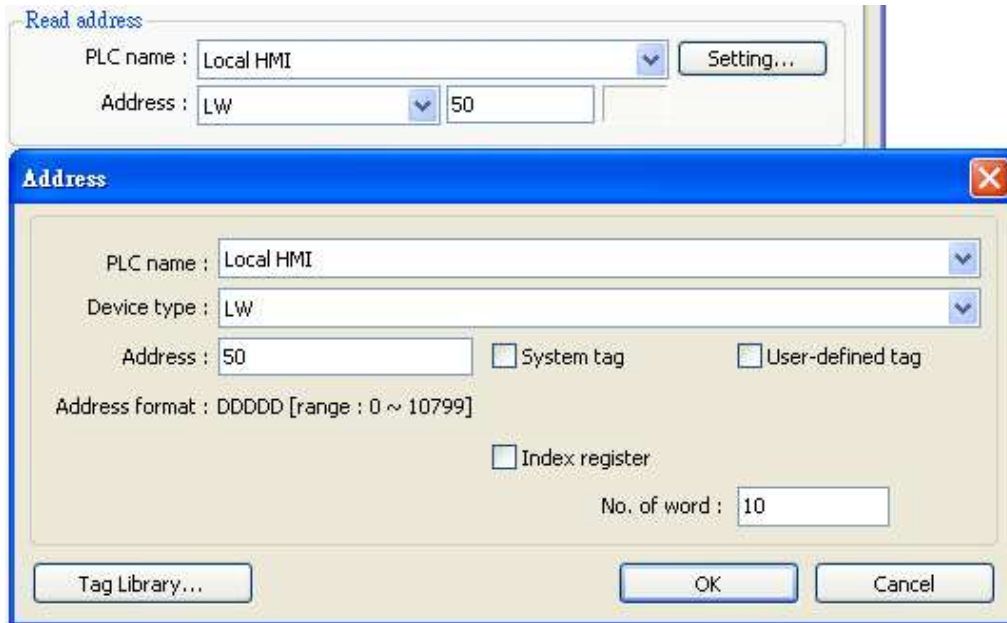



Lastly, compile  the completed project and execute Off-line  or On-line  simulation. Follow the steps below to operate the executing project:

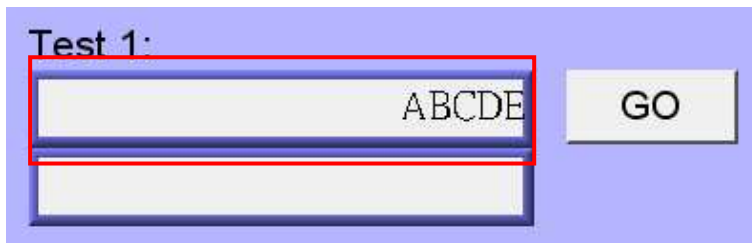

Step 1: input string



Step 2: press "GO" button

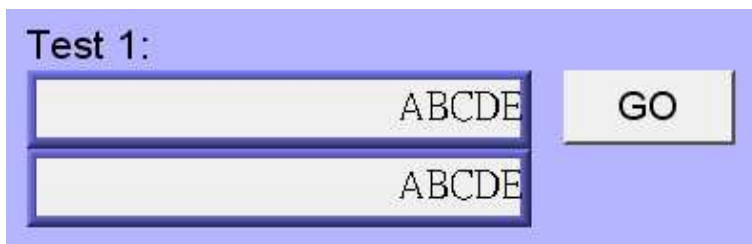

Step 3: output string

2. Initialization of a string.

Create a new macro and edit the content:

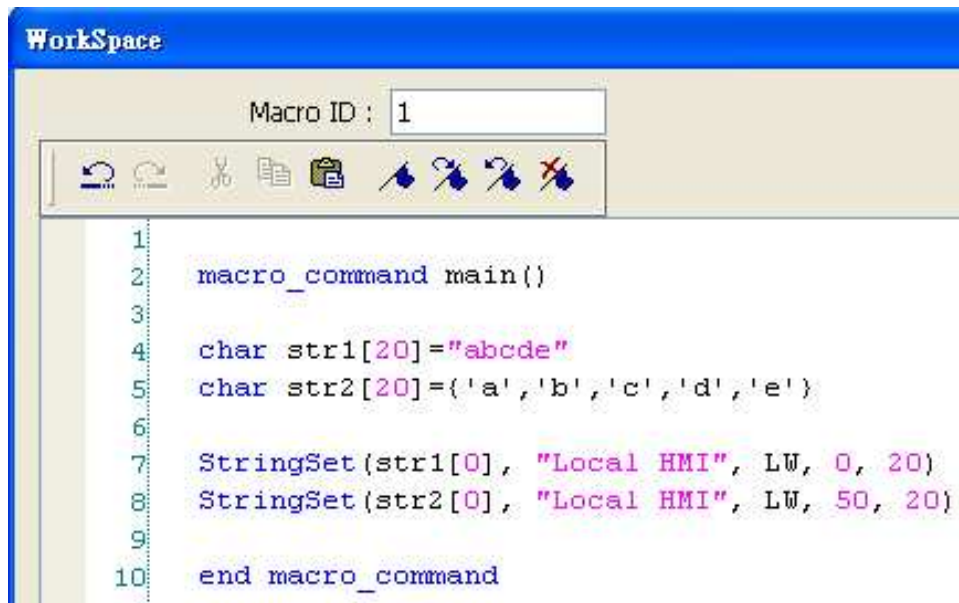

```

1
2  macro_command main()
3
4  char str1[20]="abcde"
5  char str2[20]={'a','b','c','d','e'}
6
7  StringSet(str1[0], "Local HMI", LW, 0, 20)
8  StringSet(str2[0], "Local HMI", LW, 50, 20)
9
10 end macro_command

```

The data enclosed in double quotation mark (") is viewed as a string. str1 is initialized as a string while str2 is initialized as a char array. The following snapshot of simulation shows the difference between str1 and str2 using two ASCII input objects.



Macro compiler will add a terminating null character ('\0') at the end of a string. The function "StringSet" will send each character of str1 to registers until a null character is reached. The extra characters following the null character will be ignored even if the data count is set to a larger value than the length of string. On the contrary, macro compiler will not add a terminating null character ('\0') at the end of a char array. The actual number of characters of str2 being sent to registers depends on the value of data count that is passed to the "StringSet" function.

3. A simple login page.



Create a new macro and edit the content:



```

1  macro_command main()
2  char name[20]="admin"
3  char password[20]="123456"
4  char name_input[20]
5  char password_input[20]
6  char message_success[40]="Success! Access Accepted."
7  char message_fail[40]="Fail! Access Denied."
8  char message_clear[40]
9  bool name_match=false
10 bool password_match=false
11
12 StringGet(name_input[0], "Local HMI", LW, 0, 20)
13 StringGet(password_input[0], "Local HMI", LW, 50, 20)
14 name_match = StringCompare(name_input[0], name[0])
15 password_match = StringCompare(password_input[0], password[0])
16
17 FILL(message_clear[0], 0x20, 40)// FILL with white space
18 StringSet(message_clear[0], "Local HMI", LW, 100, 40)
19 if(name_match==true and password_match==true) then
20     StringSet(message_success[0], "Local HMI", LW, 100, 40)
21 else
22     StringSet(message_fail[0], "Local HMI", LW, 100, 40)
23 end if
24 end macro_command

```

The first two “StringGet” functions will read the strings input by users and store them into arrays named name_input and password_input separately. Use the function “StringCompare” to check if the input account name and password are matched. If the account name is matched, name_match is set true; if the password is matched, password_match is set true. If both name_match and password_match are true, output the string “Success! Access Accepted.”. Otherwise, output the string “Fail! Access Denied.”.

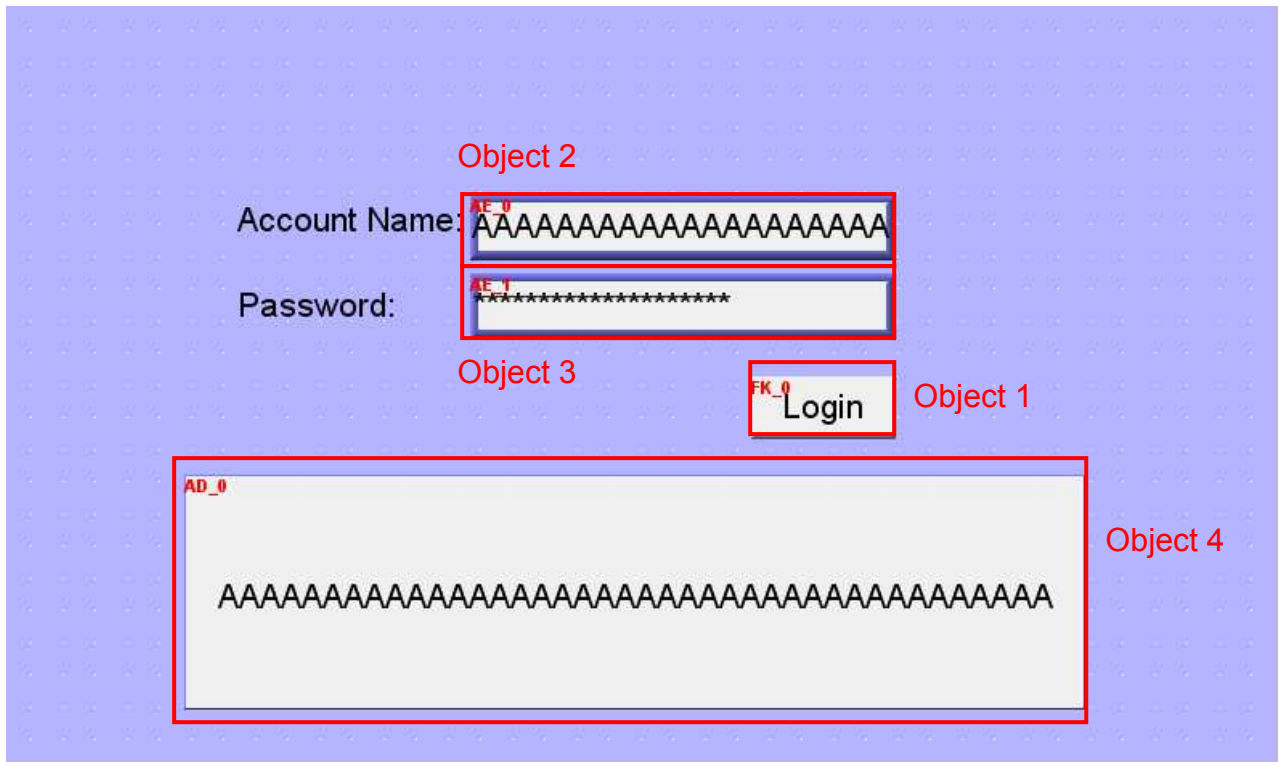
Add ASCII Input  and Function Key  objects in window 10 of the project. The settings of these objects are shown as below. Function Key object is used to execute macro_1.



Object settings:

Object 1: Function Key 



Object 2: ASCII Input 

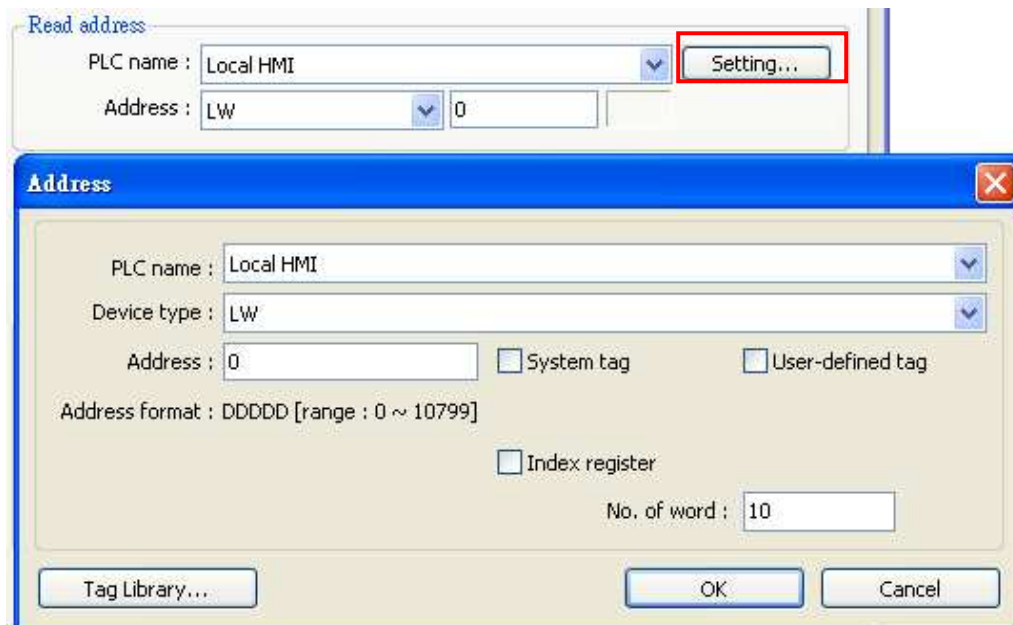

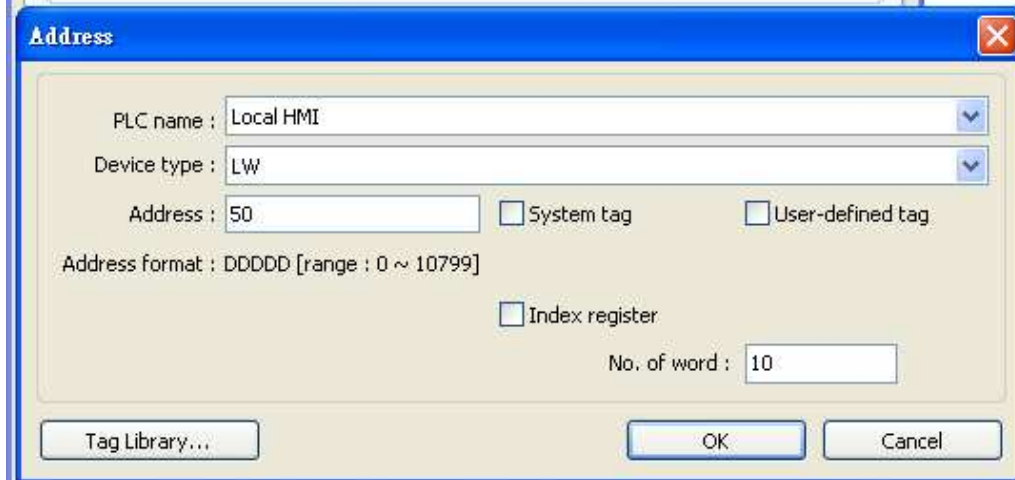

Object 3: ASCII Input 

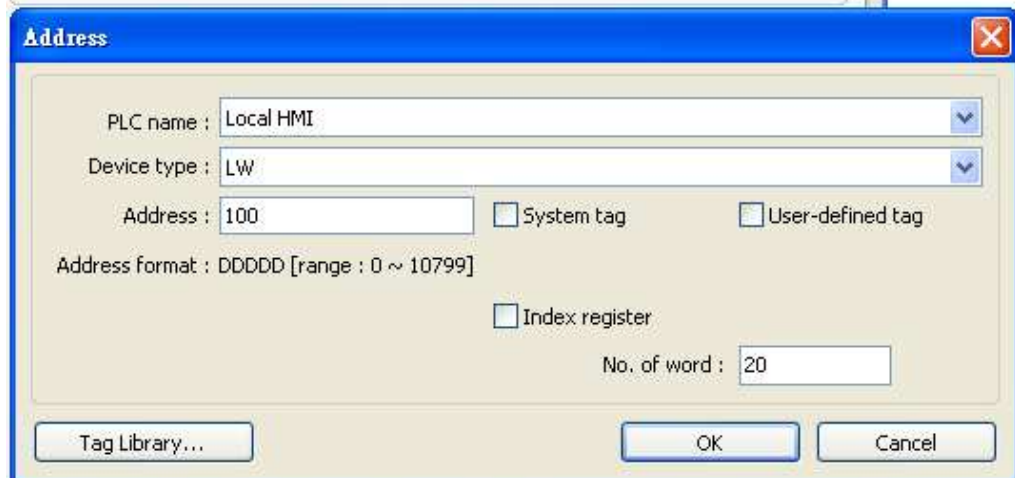
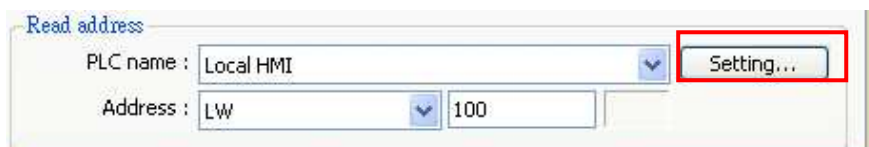

Object 4: ASCII Display 



Lastly, compile  the completed project and execute Off-line  or On-line  simulation. Follow the steps below to operate the executing project:

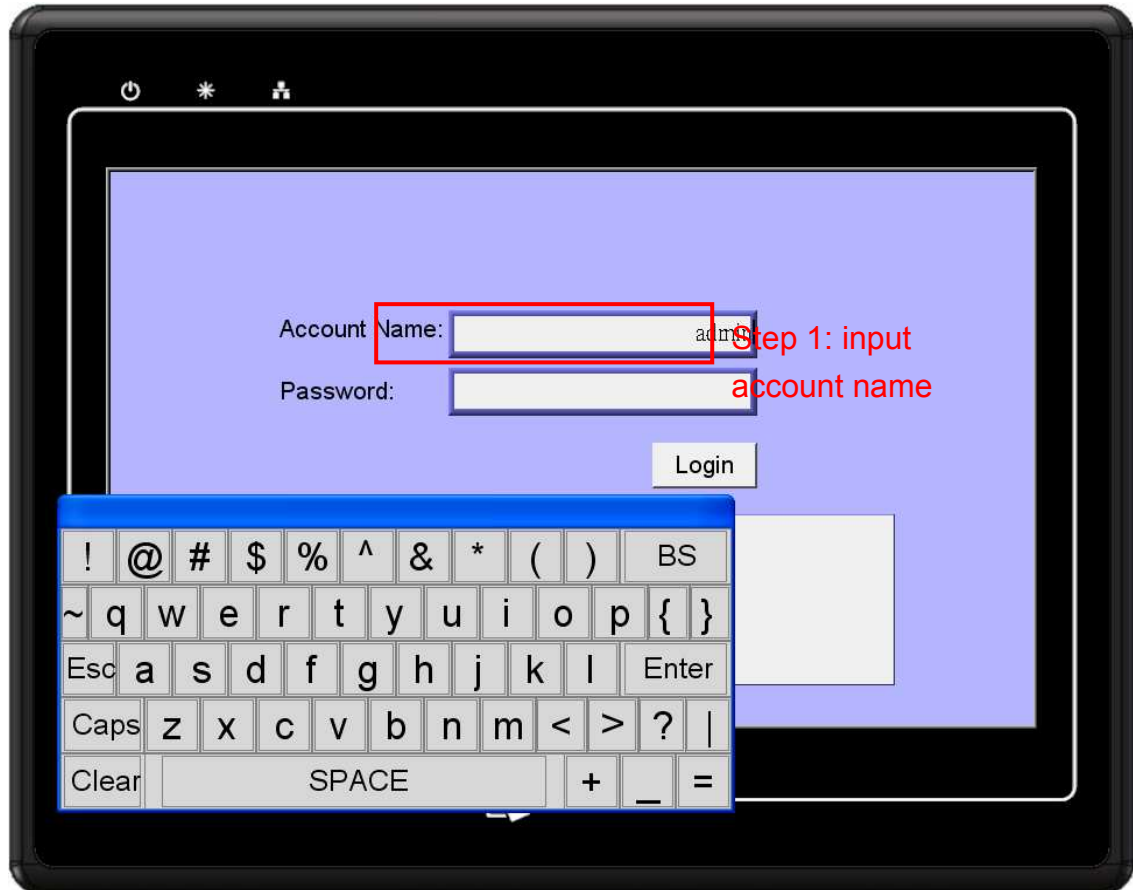

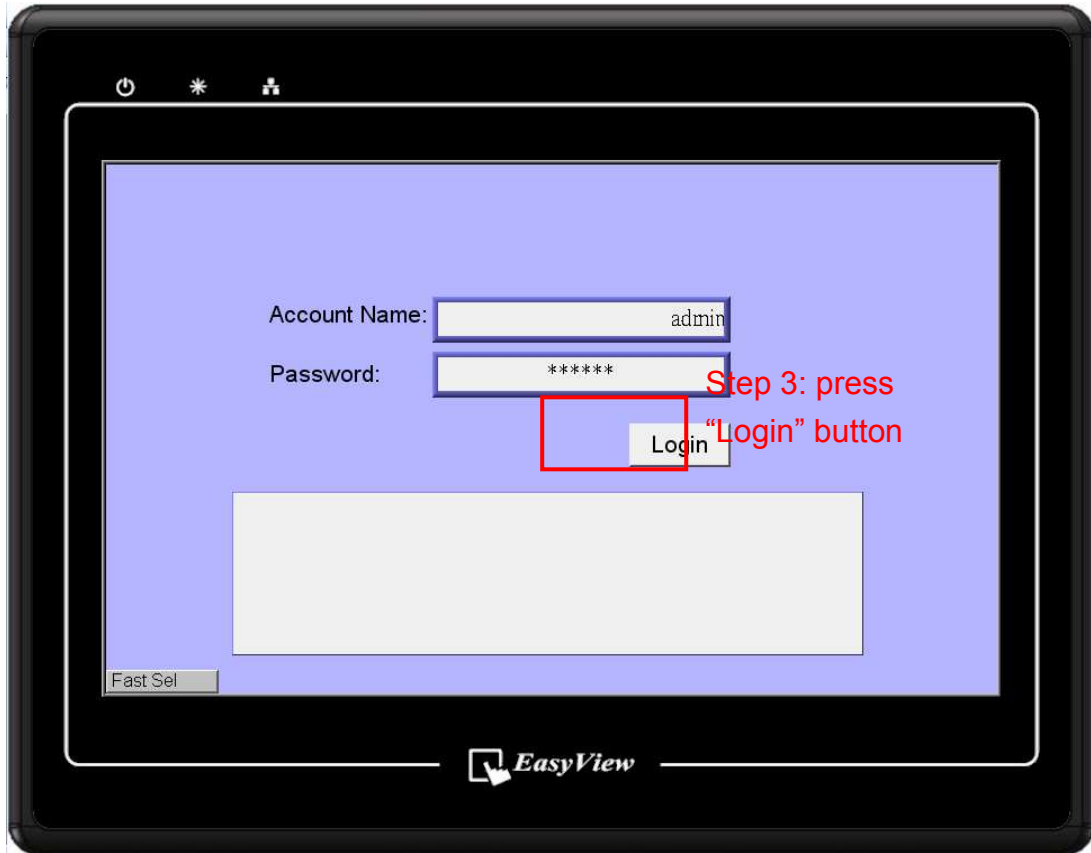
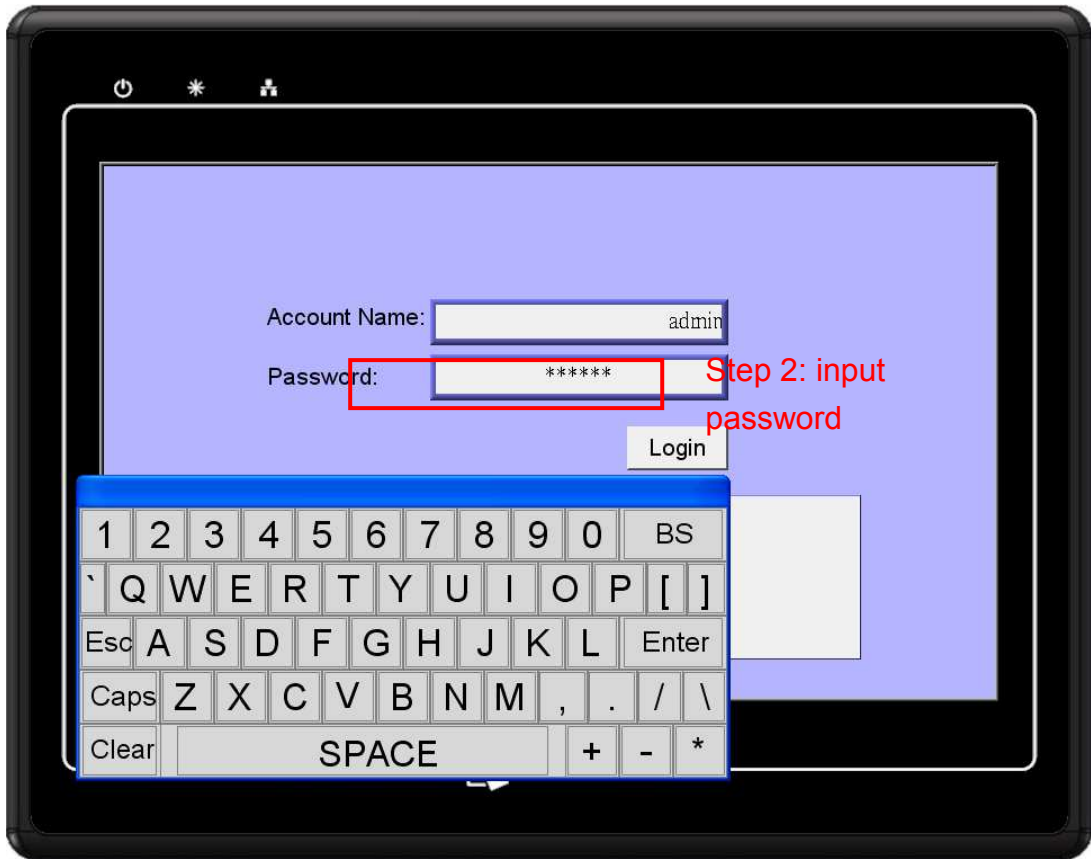

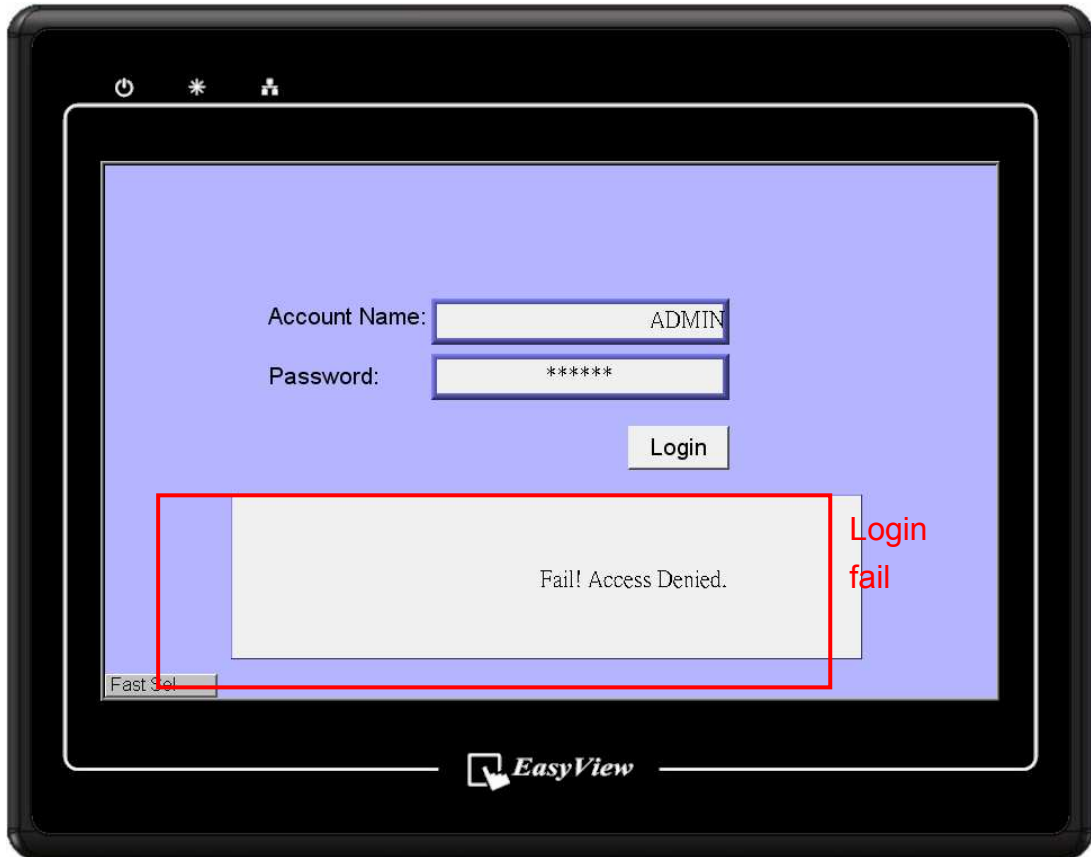
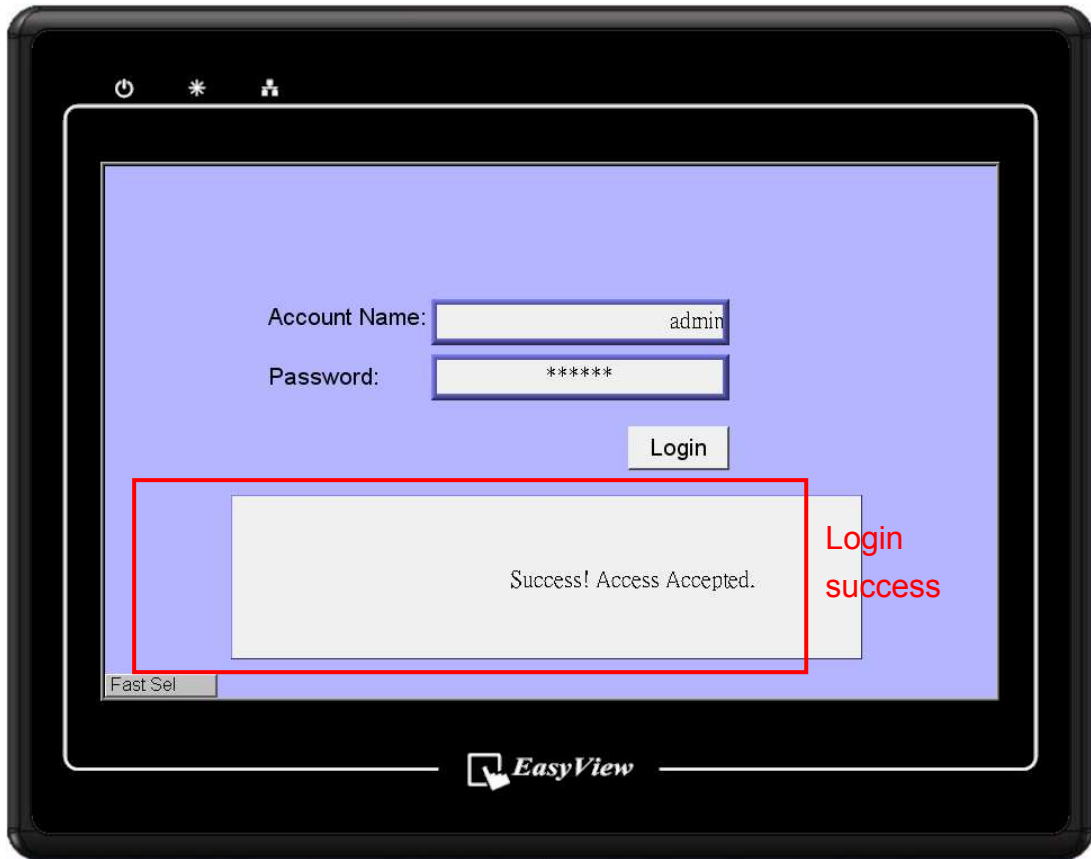

18.15 Macro Password Protection



On MACRO editing window there's the [Password protect] selection, tick it and click [Set password...] to set a password less than or equals to 10 characters (support ASCII character only, ex. "a\$#*hFds").

After setting MACRO password, users will have to input correct password when opening MACRO editing window.

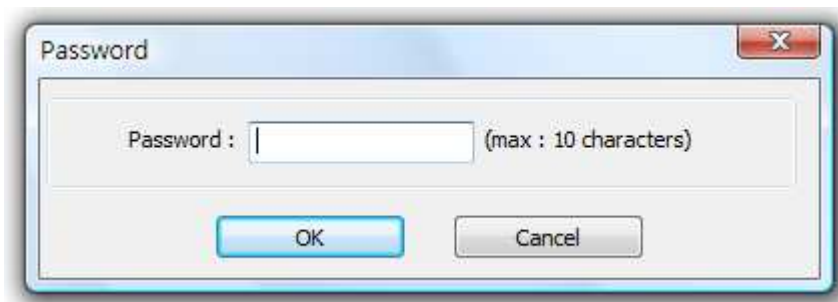

EasyBuilder8000 should be rebooted for typing the password again after 3 incorrect attempts.

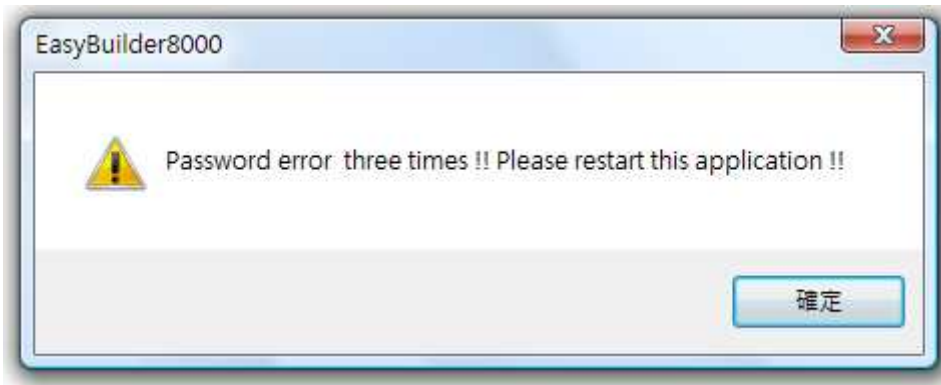

[Caution] When MACRO is password protected, decompilation of XOB file will not be able to restore MACRO contents.

Chapter 19 Set HMI as a MODBUS Server

19.1 Setting HMI as MODBUS Device

Once HMI is set as MODBUS Server, the data of HMI can be read or written via MODBUS protocol.

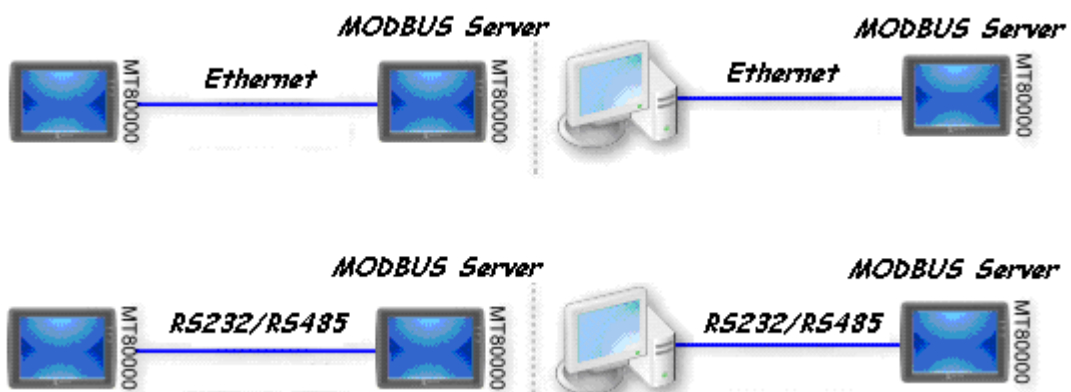

Refer to the illustration above, it shows HMI is set as MODBUS Server. The HMI, PC or other devices can use MODBUS protocol to read or write the data from HMI via Ethernet or RS232/485 interface. Please follow the steps as below.

19.1.1 Creating a MODBUS Server

First of all, add a new device “MODBUS Server” in the **[Device]** tab of **[System Parameter Settings]**. The **[PLC I/F]** can be set to RS232, RS485 2W, RS485 4W, Ethernet.

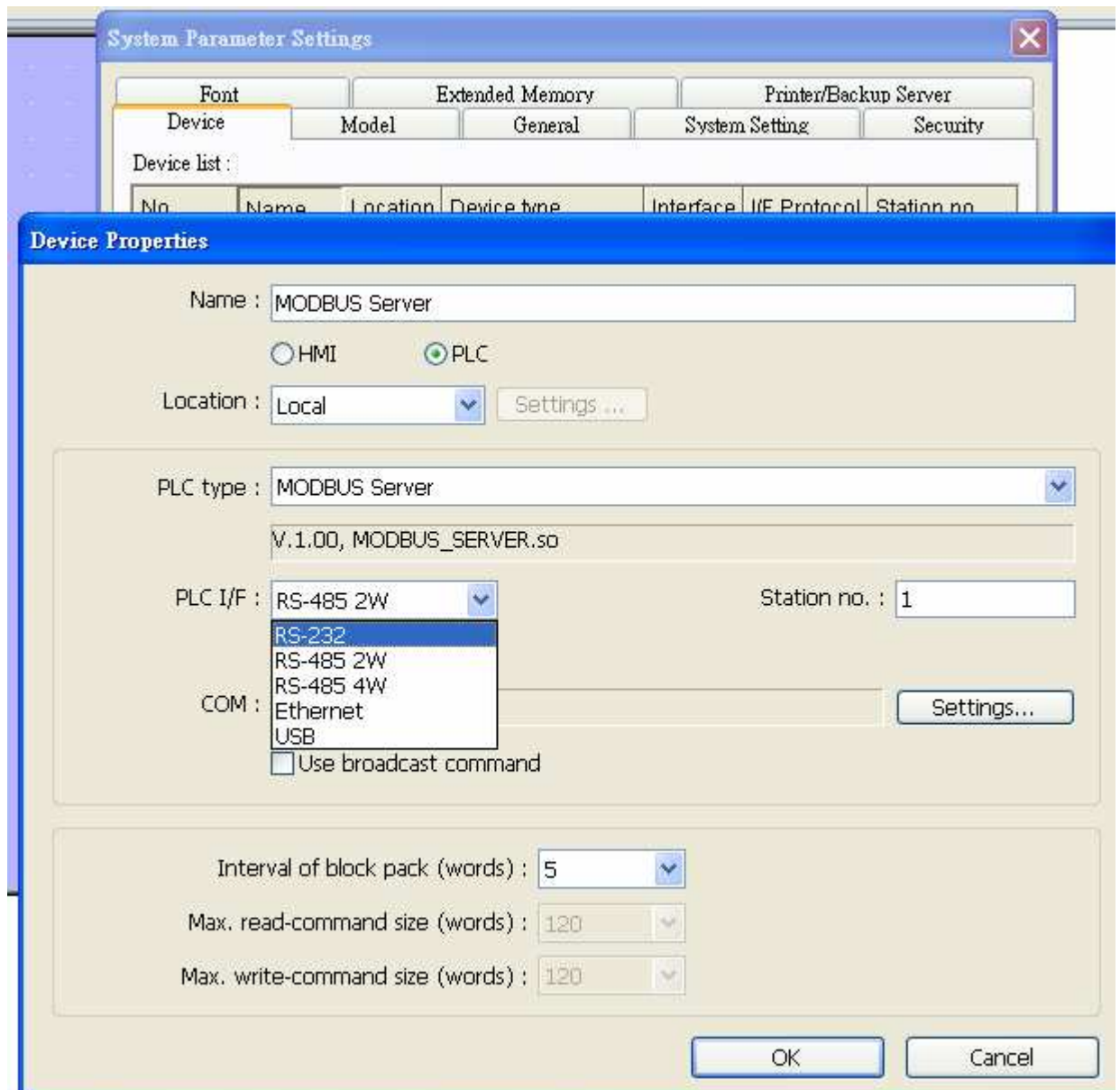

If [PLC I/F] is set as [RS232] or [RS485], please fill in [COM Port Settings] also.



If [PLC I/F] is set as [Ethernet], the [IP address] is the same as HMI.

For communication, MODBUS Server **[Port no.]** should be set the same as HMI Port no.



PLC type : MODBUS Server
 V.1.00, MODBUS_SERVER.so
 PLC I/F : Ethernet Station no. : 1
 Use UDP (User Datagram Protocol)
 IP : Local, Port=8000 (=HMI Port) **Settings...**
 Use broadcast command

Please refer to HMI Port no. to set MODBUS Server Port no. Go to **[Model]** tab of **[System Parameter Settings]**, the HMI **[Port no.]** is shown there.

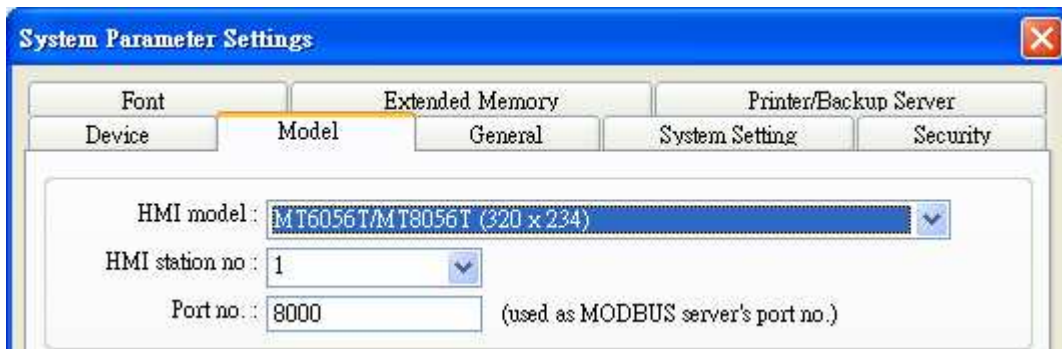

System Parameter Settings
 Font Extended Memory Printer/Backup Server
 Device Model General System Setting Security
 HMI model : MT6056T/MT8056T (20 x 234)
 HMI station no. : 1
 Port no. : 8000 (used as MODBUS server's port no.)

After finishing the setting, MODBUS Server will be listed in **[Device]** tab.

You can send MODBUS command to read or write the data from MODBUS Server after downloading the XOB file to HMI.



System Parameter Settings
 Font Extended Memory Printer/Backup Server
 Device Model General System Setting Security
 Device list :

No.	Name	Location	Device type	Interface	I/F
Local HMI	Local HMI	Local	MT6056T/MT8056T...	Disable	N/A
Local Server	MODBUS Server	Local	MODBUS Server	Ethernet(IP=Local, Port=8000)	TC

19.1.2 Read from / Write to MODBUS Server

HMI (the client) can read from / write to another HMI (the server) via MODBUS protocol. Add a new device in the project of client. If client's **[PLC I/F]** is set as **[Ethernet]**, please select "MODBUS TCP/IP" as **[PLC type]** and fill in the correct **[IP]** (the IP of server HMI) and **[Port no.]**.

The screenshot displays the 'Device Properties' dialog box for a MODBUS TCP/IP (Ethernet) device. The main dialog has the following settings:

- Name: MODBUS TCP/IP (Ethernet)
- Device type: HMI, PLC
- Location: Local (with a 'Settings...' button)
- PLC type: MODBUS TCP/IP (Ethernet) (with a dropdown arrow)
- Version: V.1.50, MODBUS_TCPIP.so
- PLC I/F: Ethernet (with a dropdown arrow)
- PLC default station no.: 1
- Use UDP (User Datagram Protocol)
- IP: 192.168.1.111, Port=8000 (with a 'Settings...' button)

The 'IP Address Settings' sub-dialog is open, showing the following configuration:

- IP address: 192 . 168 . 1 . 111
- Port no.: 8000
- Timeout (sec): 1.0 (with a dropdown arrow)
- Turn around delay (ms): 0
- Send ACK delay (ms): 0
- Parameter 1: 0
- Parameter 2: 0
- Parameter 3: 0

Buttons for 'OK' and 'Cancel' are visible at the bottom of the sub-dialog.

If the client use **[RS232/485]** interface, the **[PLC type]** must be set as "MODBUS RTU". Please make sure the communication parameter setting is correct.

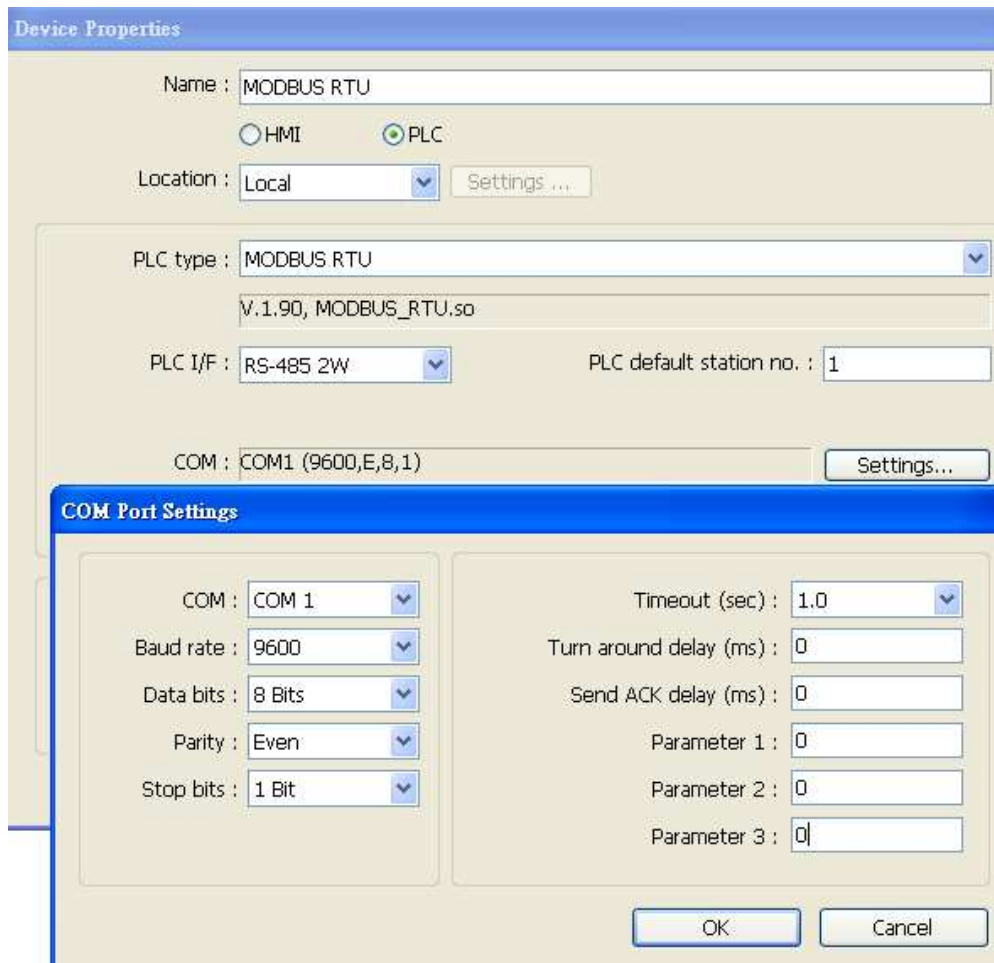

Device Properties

Name : MODBUS RTU

HMI PLC

Location : Local [Settings ...]

PLC type : MODBUS RTU
V.1.90, MODBUS_RTU.so

PLC I/F : RS-485 2W PLC default station no. : 1

COM : COM1 (9600,E,8,1) [Settings...]

COM Port Settings

COM : COM 1

Baud rate : 9600

Data bits : 8 Bits

Parity : Even

Stop bits : 1 Bit

Timeout (sec) : 1.0

Turn around delay (ms) : 0

Send ACK delay (ms) : 0

Parameter 1 : 0

Parameter 2 : 0

Parameter 3 : 0

[OK] [Cancel]

Set and click **[OK]**, a new device "MODBUS RTU" will be listed in the **[Device]** tab.

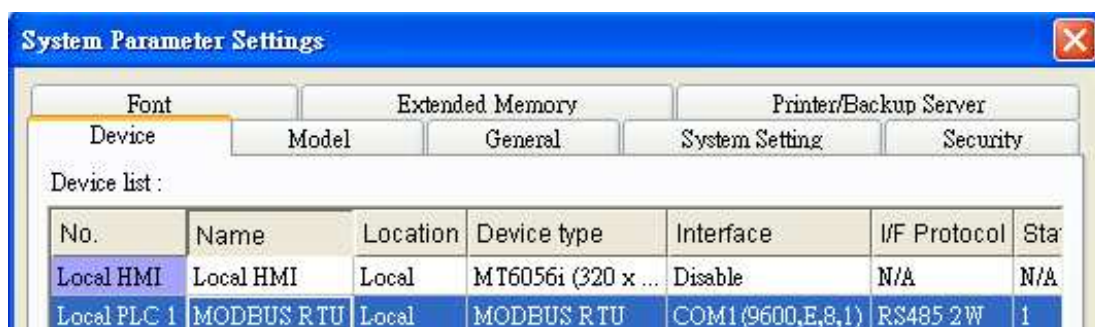

System Parameter Settings

Font Extended Memory Printer/Backup Server

Device Model General System Setting Security

Device list :

No.	Name	Location	Device type	Interface	I/F Protocol	Sta
Local HMI	Local HMI	Local	MT6056i (320 x ...	Disable	N/A	N/A
Local PLC 1	MODBUS RTU	Local	MODBUS RTU	COM1 (9600,E,8,1)	RS485 2W	1

In the setting page of each object, there is a "MODBUS RTU" in the **[PLC name]** selection list; you can then select appropriate device type and address.

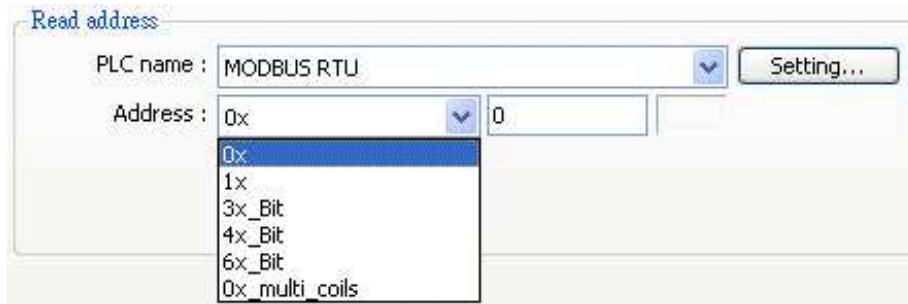

Since the server is HMI, the corresponding read and write address are as follows :

reading / writing	0x/1x(1~9999)	to reading / writing	LB(0~9998)
reading / writing	3x/4x/5x(1~9999)	to reading / writing	LW(0~9998)
reading / writing	3x/4x/5x(10000~75533)	to reading / writing	RW(0~65533)

19.2 Changing the Station Number of a MODBUS Server in Runtime

Change the related reserved registers to modify the station number of a MODBUS/ASCII server (HMI).

- [LW-9541] The station number of a MODBUS/ASCII server (COM 1)
- [LW-9542] The station number of a MODBUS/ASCII server (COM 2)
- [LW-9543] The station number of a MODBUS/ASCII server (COM 3)
- [LW-9544] The station number of a MODBUS/ASCII server (Ethernet)

19.3 About MODBUS Address Type

Address types under MODBUS protocol in EB8000 are 0x, 1x, 3x, 4x, 5x, 6x, 3x_bit and 4x_bit.

Modbus RTU function code:

0x	0x01 Read coil	0x05 write single coil
0x_multi_coils	0x01 Read coil	0x0f write multiple coil
1x	0x02 Read discrete input	N/A for write operation
3x	0x04 Read input register	N/A for write operation
4x	0x03 Read holding register	0x10 write multiple register
5x	0x03 Read holding register	0x10
6x	0x03 Read holding register	0x06 write single register
3x_bit	0x04 Read input register	N/A for write operation
4X_bit	0x03 Read holding register	0x10 write multiple register

Note:

- ① Address type “5x” is mapping to Hold Reg. The communication protocol of 5x is almost same as “4x” except “5x” makes double word swap.

If 4x contains following information

```
Address  1  2  3  4  5  6  ...
Data in word  0x1 0x2 0x3 0x4 0x5 0x6
Data  0x20001 0x40003 0x60005
```

For 5x, it becomes

```
Address  1  2  3  4  5  6  ...
Data in word  0x2 0x1 0x4 0x3 0x6 0x5
Data  0x10002 0x30004 0x50006
```

- ② Address type 6x is limited to data of one word only.
- ③ The communication protocol of 3x_bit and 4x_bit are the same as 3x and 4x. The difference is that 3x_bit and 4x_bit read single bit of the whole data.

Chapter 20 How to Connect a Barcode Device

Barcode interfaces:

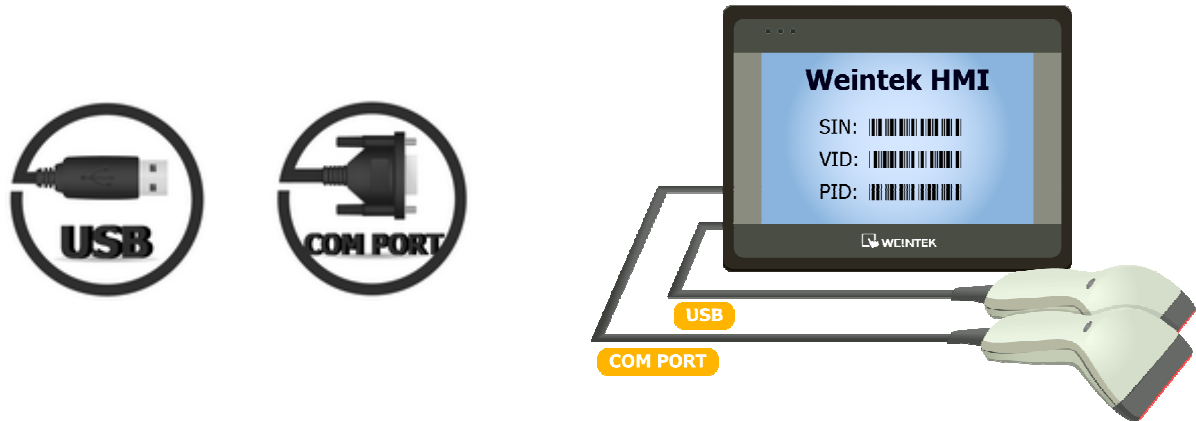

20.1 How to Connect a Barcode Device

Weintek HMI support connecting barcode (USB/COM) device. Please add a new barcode device in **[Edit]/ [System Parameter Settings]/ [Device list]** first as shown below.

Click **[Settings...]** and finish **[Barcode Device Settings]**:

The settings are detailed respectively below.

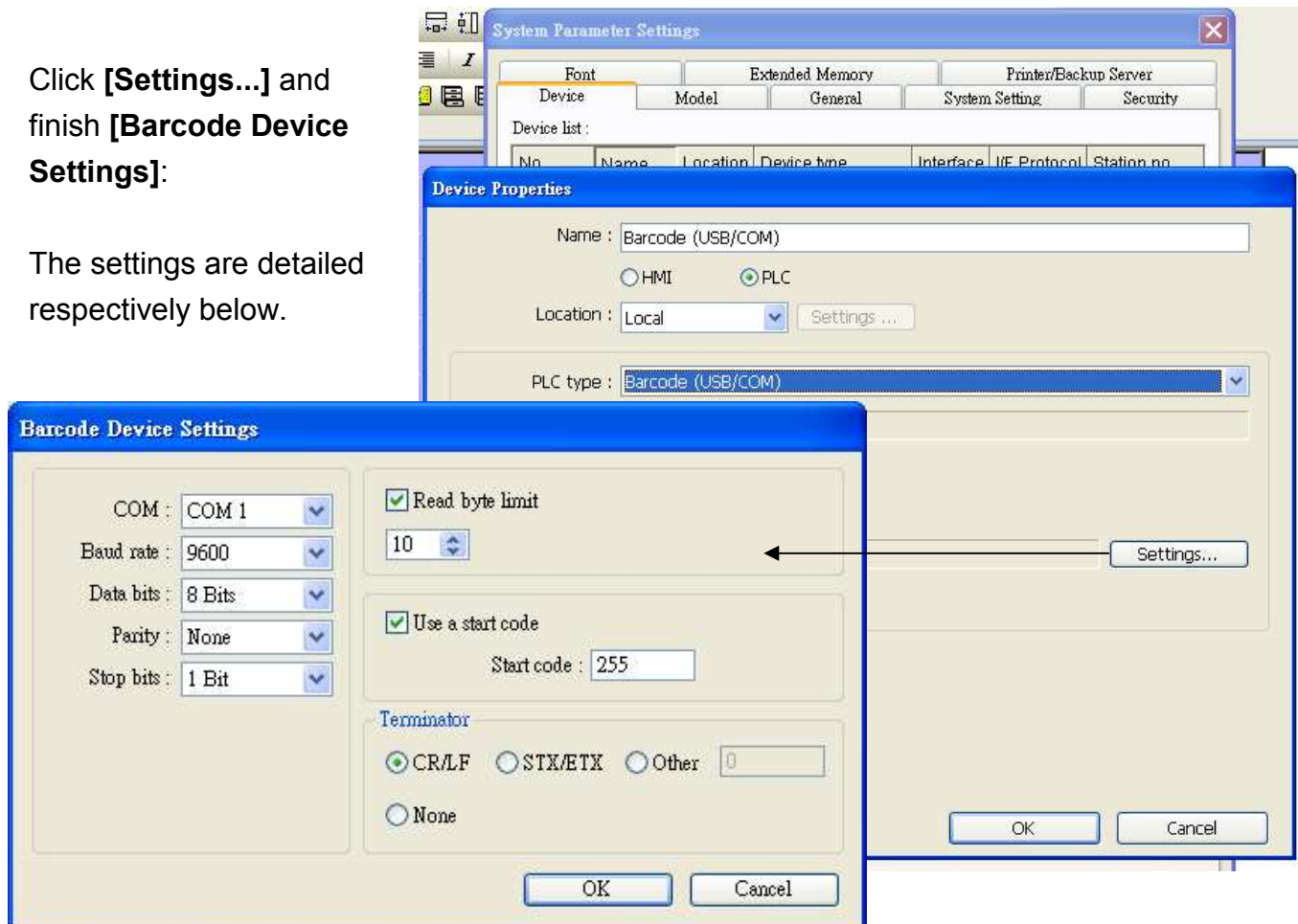

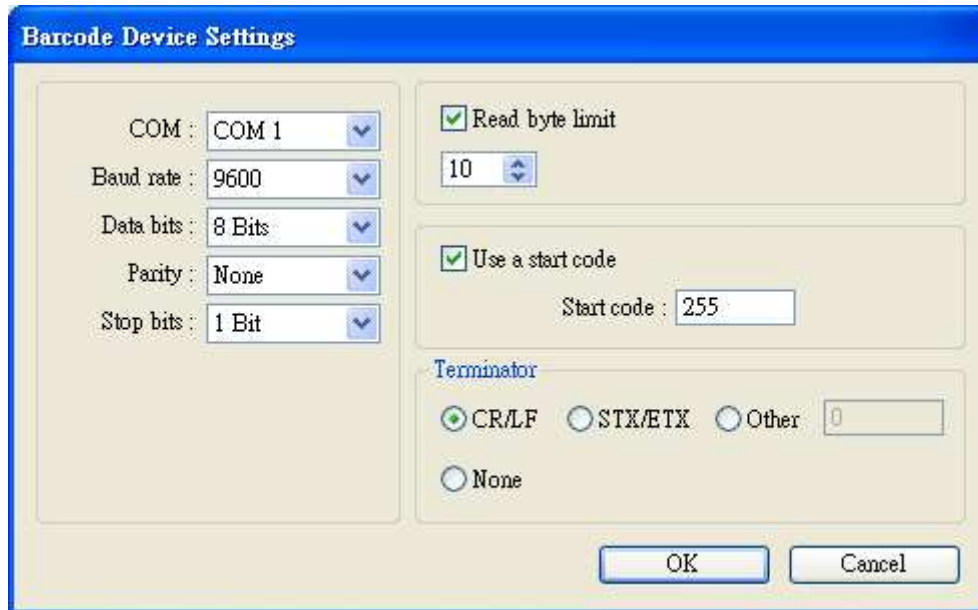

[COM]、[Baud rate]、[Data bits]、[Parity]、[Stop bits]

Barcode device can be connected to any of COM 1 ~ COM 3 or USB. When use COM interface, please set the communication parameters of barcode device accordingly. When USB interface is used, the parameters needn't to be set.

[Read byte limit]

This function will restrict the number of byte to read in order to prevent barcode device from reading too much data. The range is 10 ~ 512.

For example:

When **[Read byte limit]** is set to "10", if the data the barcode device should read: "0x34 0x39 0x31 0x32 0x30 0x30 0x34 0x37 0x30 0x38 0x33 0x38". (12 bytes)

Only the first 10 bytes will be read in this case.

"0x34 0x39 0x31 0x32 0x30 0x30 0x34 0x37 0x30 0x38"

[Use a start code]

With this function, HMI will only view the first data read by barcode device that identifies with start code to be legal input. Otherwise the data read will be ignored. All the data other than start code will be saved in designated address. Enter the decimal ASCII value of the character.

For example: if the start code is 255(0xff), and original data read:

“0xff 0x34 0x39 0x31 0x32 0x30 0x30 0x34 0x37”,

The data saved in designated barcode device address will be:

“0x34 0x39 0x31 0x32 0x30 0x30 0x34 0x37”

[Terminator]

Terminator means the end of data, when terminator is detected; it stands for the end of data stream.

[CR/LF] 0x0a or 0x0d stands for the end of data.

[STX/ETX] 0x02 or 0x03 stands for the end of data.

[Other] User can set the terminator manually.

[None] HMI will save all read data to designated address of barcode device.

After completing all settings described above, a new “Barcode” device will be listed in the **[Device list]**.

Now the barcode device can be selected in **[PLC type]** on the object parameters setting dialogue box. There are 2 types of address:

Address type	Address name	Description
Bit	FLAG	FLAG 0 indicates the status of data reading. When reading data is complete, the status of FLAG 0 will be changed from OFF to ON. It will not return to OFF automatically, users are free to set base on actual usage.
Word	BARCODE	BARCODE 0 Number of bytes currently read. BARCODE 1 ~ n Store the data read by barcode device.

The following is a barcode device setting example, the barcode read is 9421007480830. BARCODE 0 is the address of “Numeric Display” object

(bytes) and BARCODE 1 ~ n is the address of “ASCII Display” object (barcode).



Address : BARCODE 0
BYTES : 13
 Address : BARCODE 1~n
BARCODE : 9421007480830

In the example the data stored by barcode device corresponding address are listed below:

Barcode corresponding address	Data
BARCODE 0	13 bytes (decimal) The data saved in this address is 14 bytes = 7 words. If the number of byte is odd, system will add a byte (0x00) to make it even.
BARCODE 1	3439HEX
BARCODE 2	3132HEX
BARCODE 3	3030HEX
BARCODE 4	3437HEX
BARCODE 5	3038HEX
BARCODE 6	3338HEX
BARCODE 7	0030HEX
BARCODE 8	empty



- USB barcode interface does not support on-line simulation.
- HMI now only supports barcode device to connect with one USB interface. When Device Table of project includes this kind of device, keyboard will be detected as barcode device, and LB-9064 will be set to ON automatically when power on. For restoring keyboard to normal function and to pause using barcode device, set LB-9064 to OFF. For restoring barcode device, simply set LB-9064 to ON.



Please confirm your Internet connection before downloading the demo project.

Chapter 21 Ethernet Communication and Multi-HMI Connection

There are two ways of Ethernet communication:

1. Use RJ45 straight through cable + hub

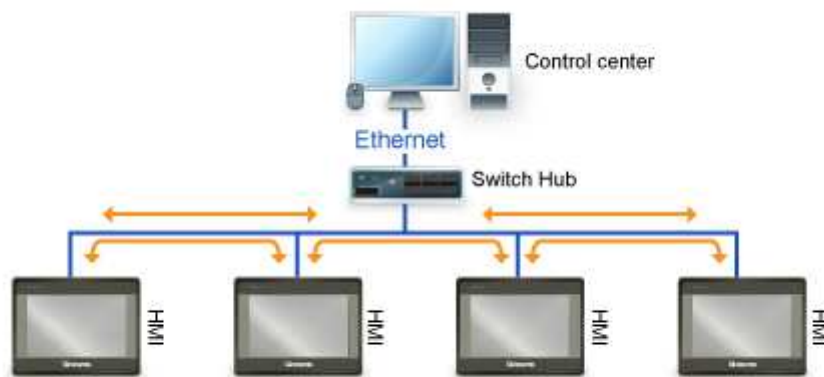

2. Use RJ45 crossover cable and without hub, but this is limited to the condition of point to point connection (HMI to HMI or PC to HMI).

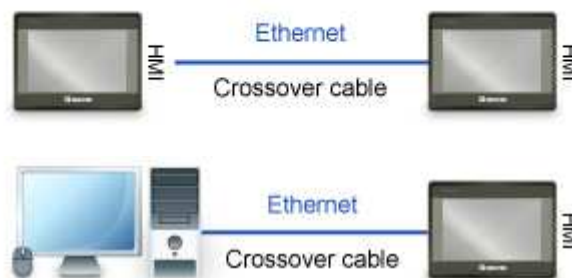

Through Ethernet network, EasyBuilder Pro provides the following methods for data transmission:

1. HMI to HMI communication
2. PC to HMI communication
3. Operating the PLC connected to other HMI

21.1 HMI to HMI Communication



In the communication between HMI A and HMI B, when using  [set bit] object on HMI A to control [LB-0] of HMI B:

1. Set the IP address of the two HMI, example: HMI A = 192.168.1.1, HMI B = 192.168.1.2

2. HMI A project /
[System Parameter Settings]
 / **[Device list]**
 Add a remote HMI B.
 IP 192.168.1.2

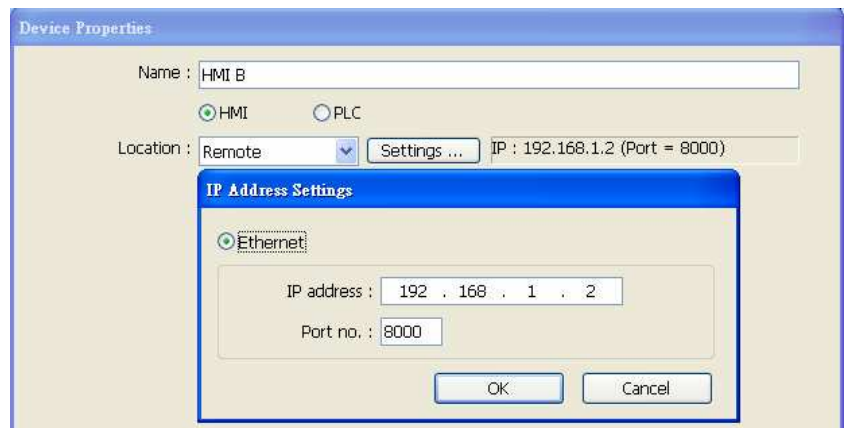

2.  **Set Bit / [PLC name]**
 select "HMI B" to control the
 address of remote HMI.

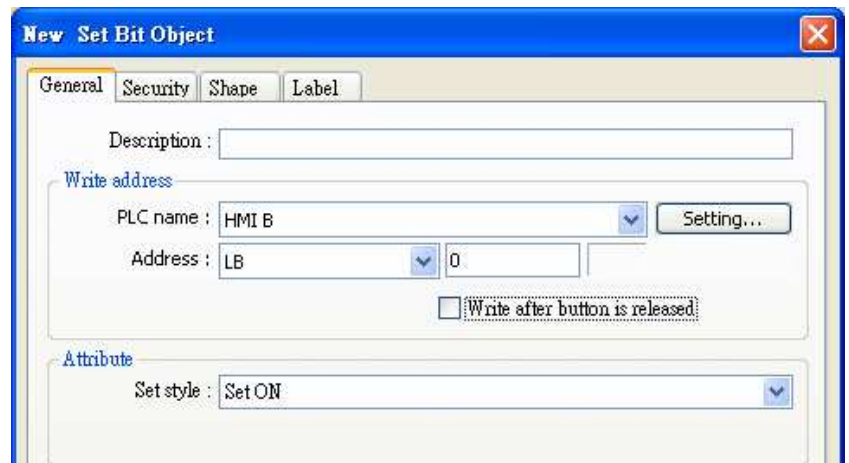

■ One HMI can handle requests from a maximum of other 32 HMI simultaneously.

21.2 PC to HMI Communication

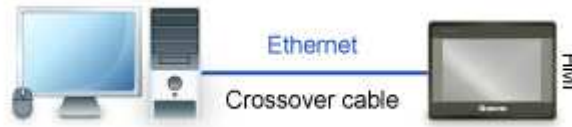

With On-line Simulation Function, PC can collect data of HMI through Ethernet network and save the data files on PC.

PC can control HMI by operating system reserved register.

HMI can control PC, for example, commanding PC to save data from HMI or PLC.

Suppose PC is going to communicate with two HMI (HMI A and HMI B), the MTP project on PC setting procedure:

1. Set the IP address of the two HMI, example: HMI A = 192.168.1.1, HMI B = 192.168.1.2

2. PC project/
[System Parameter] /
[Device List], add remote
 HMI A & HMI B.

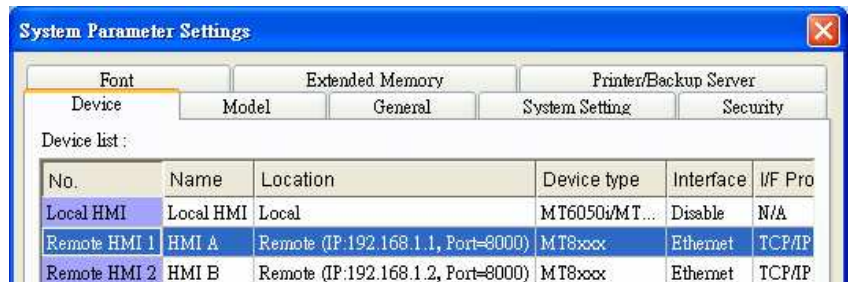

3.  **Set Bit /**
[PLC name], select the
 device to be controlled, if
 it's HMI A [LB], select
 "HMI A".

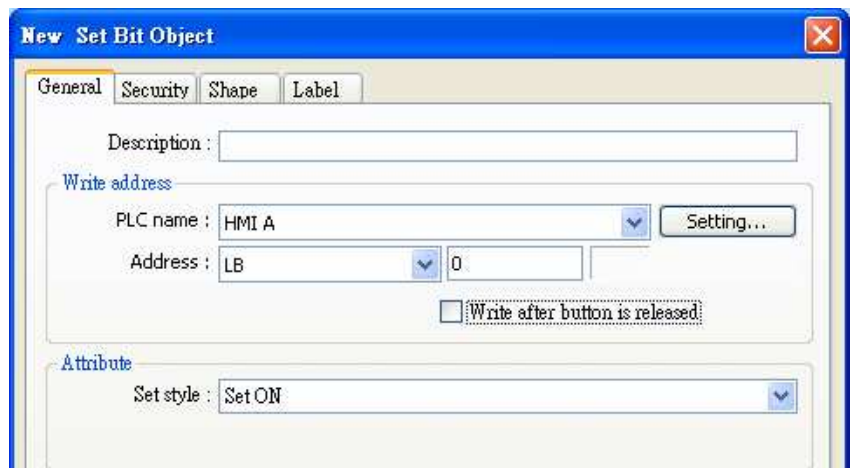

- The number of HMI that a PC can control is not limited.
- HMI can control data on PC by considering PC another HMI.

Add PC as a new Remote HMI device to the HMI MTP project and set the IP address of the Remote HMI pointing to the PC.

21.3 Operate the PLC Connected with Other HMI

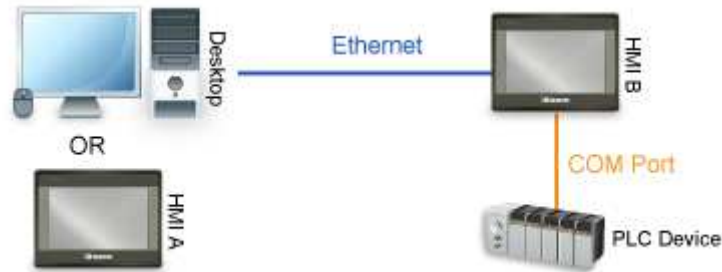

Through Ethernet network, PC or HMI can operate PLC that is connected to other HMI; for example, a Mitsubishi PLC connected to COM 1 of HMI B. When using PC or HMI A to read PLC data, the procedure for setting PC or HMI A MTP projects:

1. Set HMI B IP, for example: 192.168.1.2

2. PC or HMI A project / **[System Parameter]** / **[Device list]**, add a remote PLC, and set correct parameters. Since this PLC is connected to remote HMI B, set **IP** the same as HMI B (192.168.1.2).

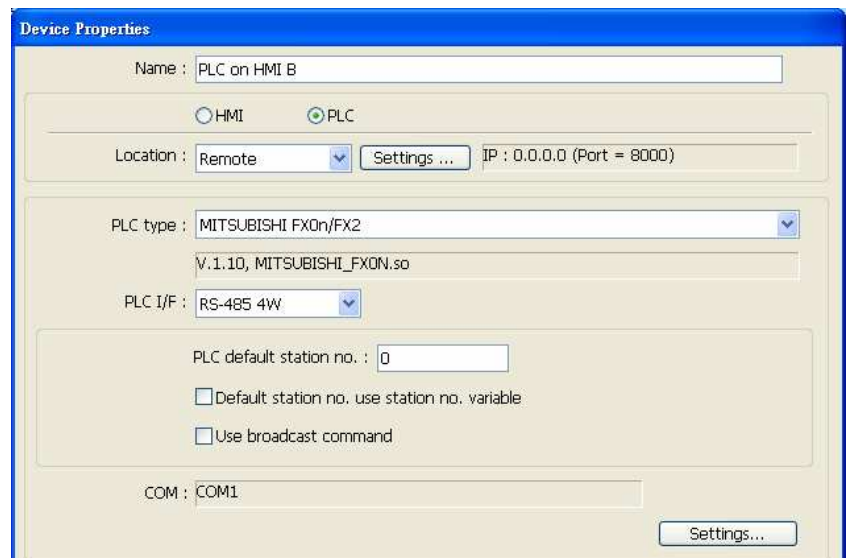

3.  **Set Bit/ [PLC name]**

select "PLC on HMI B" (remote PLC) to control the PLC connected to HMI B.

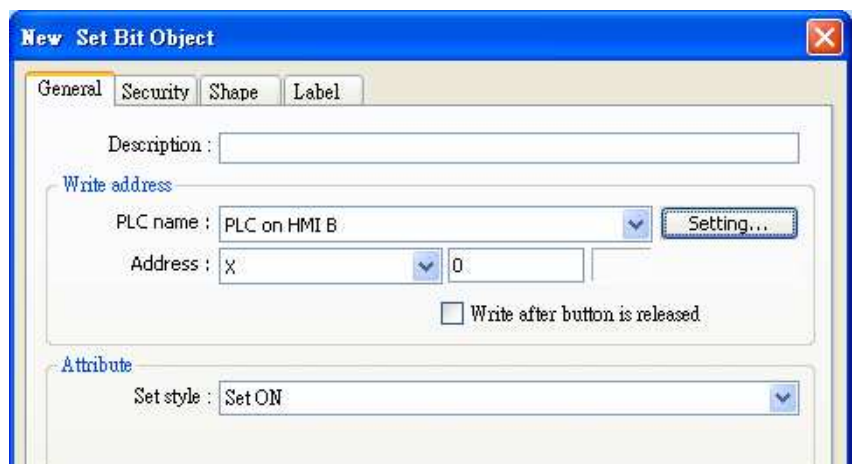

Chapter 22 System Reserved Words / Bits

Some Local Words and Local Bits are reserved for system usage. These registers are all with different functions described below:

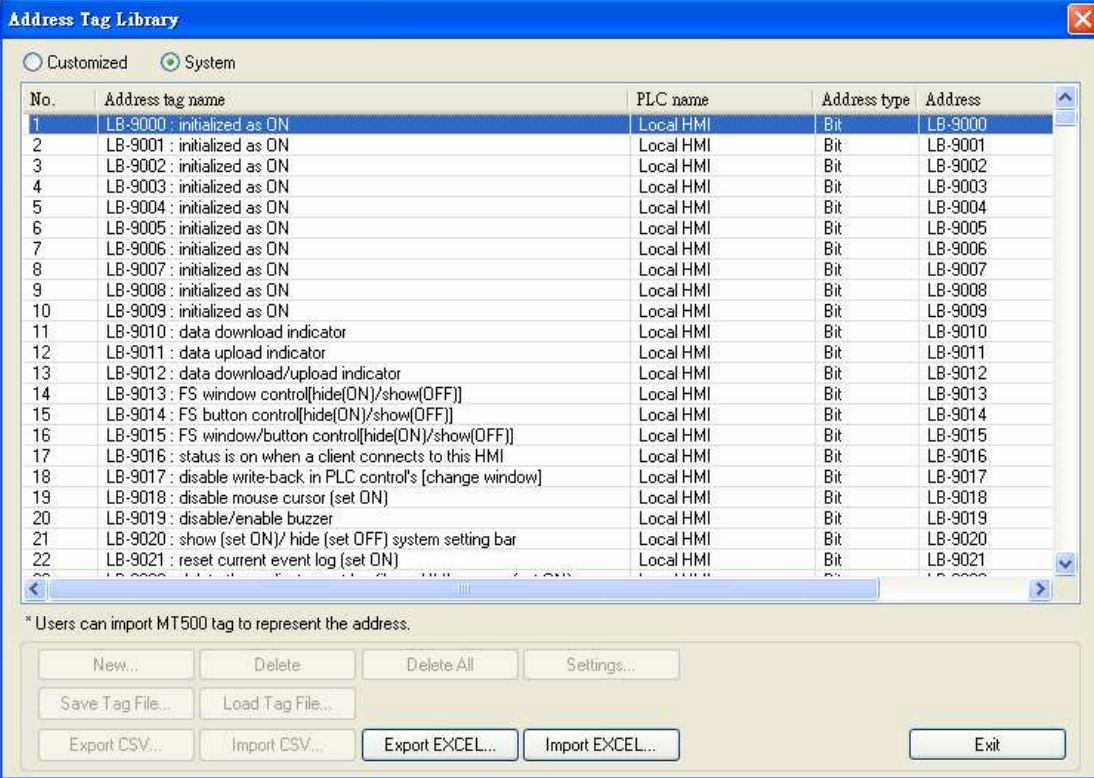

The screenshot shows the 'Address Tag Library' window with the 'System' tab selected. It contains a table of system reserved words and bits, along with a control panel at the bottom.

No.	Address tag name	PLC name	Address type	Address
1	LB-9000 : initialized as ON	Local HMI	Bit	LB-9000
2	LB-9001 : initialized as ON	Local HMI	Bit	LB-9001
3	LB-9002 : initialized as ON	Local HMI	Bit	LB-9002
4	LB-9003 : initialized as ON	Local HMI	Bit	LB-9003
5	LB-9004 : initialized as ON	Local HMI	Bit	LB-9004
6	LB-9005 : initialized as ON	Local HMI	Bit	LB-9005
7	LB-9006 : initialized as ON	Local HMI	Bit	LB-9006
8	LB-9007 : initialized as ON	Local HMI	Bit	LB-9007
9	LB-9008 : initialized as ON	Local HMI	Bit	LB-9008
10	LB-9009 : initialized as ON	Local HMI	Bit	LB-9009
11	LB-9010 : data download indicator	Local HMI	Bit	LB-9010
12	LB-9011 : data upload indicator	Local HMI	Bit	LB-9011
13	LB-9012 : data download/upload indicator	Local HMI	Bit	LB-9012
14	LB-9013 : FS window control[hide(ON)/show(OFF)]	Local HMI	Bit	LB-9013
15	LB-9014 : FS button control[hide(ON)/show(OFF)]	Local HMI	Bit	LB-9014
16	LB-9015 : FS window/button control[hide(ON)/show(OFF)]	Local HMI	Bit	LB-9015
17	LB-9016 : status is on when a client connects to this HMI	Local HMI	Bit	LB-9016
18	LB-9017 : disable write-back in PLC control's [change window]	Local HMI	Bit	LB-9017
19	LB-9018 : disable mouse cursor (set ON)	Local HMI	Bit	LB-9018
20	LB-9019 : disable/enable buzzer	Local HMI	Bit	LB-9019
21	LB-9020 : show (set ON)/ hide (set OFF) system setting bar	Local HMI	Bit	LB-9020
22	LB-9021 : reset current event log (set ON)	Local HMI	Bit	LB-9021

* Users can import MT500 tag to represent the address.

Buttons: New..., Delete, Delete All, Settings..., Save Tag File..., Load Tag File..., Export CSV..., Import CSV..., Export EXCEL..., Import EXCEL..., Exit

22.1 The Address Ranges of Local HMI Memory

22.1.1 Bits

Memory	Device Type	Range	Format
Local Memory Bits	LB	0 ~ 12095	DDDDD
Local Word Bits	LW_BIT	0 ~ 1079915	DDDDDdd DDDDD: address dd: bit no. (00 ~ 15)
Retentive Memory Bit Index	RBI	0 ~ 65535f	DDDDDh DDDDD: address h: bit no. (0 ~ f) Example: 567 <u>a</u> RW_Bit address = 567 + [LW-9000] bit offset = a
Retentive Memory Word Bits	RW_Bit	0 ~ 524287f	DDDDDh DDDDD: address h: bit no. (0 ~ f)
Retentive Memory A Word Bits	RW_A_Bit	0 ~ 65535f	DDDDh DDDDD: address h: bit no. (0 ~ f)

22.1.2 Words

Memory	Device Type	Range	Format
Local Memory Words	LW	0 ~ 10799	DDDDD
Retentive Memory Words	RW	0 ~ 524287	DDDDDD
Retentive Memory Word Index	RWI	0 ~ 65535	DDDDD Example: 567 RW address = 567 + [LW-9000]
Retentive Memory A Word	RW_A	0 ~ 65535	DDDDD
Extended Memory Words	EM0 ~ EM9	0 ~ 1073741823	DDDDDDDDDD Limited by device, max. 2G

22.2 HMI Time

Address	Description	Read(R)/Write(W)/Control(Y)		
		Local HMI	MACRO R/Y	Remote HMI R/Y
LW-9010	(16bit-BCD) : local second	R/W	R/Y	R/Y
LW-9011	(16bit-BCD) : local minute	R/W	R/Y	R/Y
LW-9012	(16bit-BCD) : local hour	R/W	R/Y	R/Y
LW-9013	(16bit-BCD) : local day	R/W	R/Y	R/Y
LW-9014	(16bit-BCD) : local month	R/W	R/Y	R/Y
LW-9015	(16bit-BCD) : local year	R/W	R/Y	R/Y
LW-9016	(16bit-BCD) : local week	R	R	R
LW-9017	(16bit) : local second	R/W	R/Y	R/Y
LW-9018	(16bit) : local minute	R/W	R/Y	R/Y
LW-9019	(16bit) : local hour	R/W	R/Y	R/Y
LW-9020	(16bit) : local day	R/W	R/Y	R/Y
LW-9021	(16bit) : local month	R/W	R/Y	R/Y
LW-9022	(16bit) : local year	R/W	R/Y	R/Y
LW-9023	(16bit) : local week	R	R	R
LW-9030	(32bit) : system time (unit : 0.1 second)	R	R	R
LW-9048	(16bit) : time (0 : AM, 1 : PM)	R/W	R/Y	R/Y
LW-9049	(16bit) : local hour (12-hour format)	R/W	R/Y	R/Y

22.3 User Name and Password

Address	Description	Read(R)/Write(W)/Control(Y)		
		Local HMI	MACRO R/Y	Remote HMI R/Y
LB-9050	user logout	W	Y	Y
LB-9060	password error	R	R	R
LB-9061	update password (set ON)	W	Y	Y
LW-9219	(16bit) : user no. (1~12)	R/W	R/Y	R/Y
LW-9220	(32bit) : password	R/W	R/Y	R/Y
LW-9222	(16bit) : classes can be operated for current user (bit 0:A, bit 1:B,bit 2:C, ...)	R	R	R
LW-9500	(32bit) : user 1's password	R/W	R/Y	R/Y
LW-9502	(32bit) : user 2's password	R/W	R/Y	R/Y
LW-9504	(32bit) : user 3's password	R/W	R/Y	R/Y
LW-9506	(32bit) : user 4's password	R/W	R/Y	R/Y
LW-9508	(32bit) : user 5's password	R/W	R/Y	R/Y
LW-9510	(32bit) : user 6's password	R/W	R/Y	R/Y
LW-9512	(32bit) : user 7's password	R/W	R/Y	R/Y
LW-9514	(32bit) : user 8's password	R/W	R/Y	R/Y
LW-9516	(32bit) : user 9's password	R/W	R/Y	R/Y
LW-9518	(32bit) : user 10's password	R/W	R/Y	R/Y
LW-9520	(32bit) : user 11's password	R/W	R/Y	R/Y
LW-9522	(32bit) : user 12's password	R/W	R/Y	R/Y



Please confirm your Internet connection before downloading the demo project.

22.4 Data Sampling

Address	Description	Read(R)/Write(W)/Control(Y)		
		Local HMI	MACRO R/Y	Remote HMI R/Y
LB-9025	delete the earliest data sampling file on HMI memory (set ON)	W	Y	Y
LB-9026	delete all data sampling files on HMI memory (set ON)	W	Y	Y
LB-9027	refresh data sampling information on HMI memory (set ON)	W	Y	Y
LB-9034	save event/data sampling to HMI, USB disk, SD card (set ON)	W	Y	Y
LB-11949	delete the earliest data sampling file on SD card (set ON)	W	Y	Y
LB-11950	delete all data sampling files on SD card (set ON)	W	Y	Y
LB-11951	refresh data sampling information on SD card (set ON)	W	Y	Y
LB-11952	delete the earliest data sampling file on USB 1 (set ON)	W	Y	Y
LB-11953	delete all data sampling files on USB 1 (set ON)	W	Y	Y
LB-11954	refresh data sampling information on USB 1 (set ON)	W	Y	Y
LB-11955	delete the earliest data sampling file on USB 2 (set ON)	W	Y	Y
LB-11956	delete all data sampling files on USB 2 (set ON)	W	Y	Y
LB-11957	refresh data sampling information on USB 2 (set ON)	W	Y	Y
LW-9063	(16bit) : no. of data sampling files on HMI memory	R	R	R
LW-9064	(32bit) : size of data sampling files on HMI memory	R	R	R
LW-10489	(16bit) : no. of data sampling files on SD card	R	R	R
LW-10490	(32bit) : size of data sampling files on SD card	R	R	R
LW-10492	(16bit) : no. of data sampling files on USB 1	R	R	R

LW-10493	(32bit) : size of data sampling files on USB 1	R	R	R
LW-10495	(16bit) : no. of data sampling files on USB 2	R	R	R
LW-10496	(32bit) : size of data sampling files on USB 2	R	R	R

22.5 Event Log

Address	Description	Read(R)/Write(W)/Control(Y)		
		Local HMI	MACRO R/Y	Remote HMI R/Y
LB-9021	reset current event log (set ON)	W	Y	Y
LB-9022	delete the earliest event log file on HMI memory (set ON)	W	Y	Y
LB-9023	delete all event log files on HMI memory (set ON)	W	Y	Y
LB-9024	refresh event log information on HMI memory (set ON)	W	Y	Y
LB-9034	save event/data sampling to HMI, USB disk, SD card (set ON)	W	Y	Y
LB-9042	acknowledge all alarm events (set ON)	W	Y	Y
LB-9043	unacknowledged events exist (when ON)	R	R	R
LB-11940	delete the earliest event log file on SD card (set ON)	W	Y	Y
LB-11941	delete all event log files on SD card (set ON)	W	Y	Y
LB-11942	refresh event log information on SD card (set ON)	W	Y	Y
LB-11943	delete the earliest event log file on USB 1 (set ON)	W	Y	Y
LB-11944	delete all event log files on USB 1 (set ON)	W	Y	Y
LB-11945	refresh event log information on USB 1 (set ON)	W	Y	Y
LB-11946	delete the earliest event log file on USB 2 (set ON)	W	Y	Y
LB-11947	delete all event log files on USB 2 (set ON)ON)	W	Y	Y
LB-11948	refresh event log information on USB 2 (set ON)	W	Y	Y
LW-9060	(16bit) : no. of event log files on HMI memory	R	R	R
LW-9061	(32bit) : size of event log files on HMI memory	R	R	R
LW-9450	(16bit) : time tag of event log – second *Note1	R/W	R/Y	R/Y
LW-9451	(16bit) : time tag of event log – minute*Note1	R/W	R/Y	R/Y
LW-9452	(16bit) : time tag of event log – hour *Note1	R/W	R/Y	R/Y
LW-9453	(16bit) : time tag of event log – day *Note1	R/W	R/Y	R/Y

LW-9454	(16bit) : time tag of event log – month *Note1	R/W	R/Y	R/Y
LW-9455	(16bit) : time tag of event log – year*Note1	R/W	R/Y	R/Y
LW-10480	(16bit) : no. of event log files on SD card	R	R	R
LW-10481	(32bit) : size of event log files on SD card	R	R	R
LW-10483	(16bit) : no. of event log files on USB 1	R	R	R
LW-10484	(32bit) : size of event log files on USB 1	R	R	R
LW-10486	(16bit) : no. of event log files on USB 2	R	R	R
LW-10487	(32bit) : size of event log files on USB 2	R	R	R



1. If LW-9450 ~ LW-9455 are used as tags of Event Log time source, please set [system parameters] / [General] correctly.

22.6 HMI Hardware Operation

Address	Description	Read(R)/Write(W)/Control(Y)		
		Local HMI	MACRO R/Y	Remote HMI R/Y
LB-9018	disable mouse cursor (set ON)	R/W	R/Y	R/Y
LB-9019	disable/enable buzzer	R/W	R/Y	R/Y
LB-9020	show (set ON)/ hide (set OFF) system setting bar	R/W	R/Y	R/Y
LB-9033	disable(when on)/enable (when off) HMI upload function(i series only) *Note1	R/W	R/Y	R
LB-9040	backlight up (set ON) *Note2	W	Y	Y
LB-9041	backlight down (set ON) *Note2	W	Y	Y
LB-9047	reboot HMI (set ON when LB9048 is on)	W	Y	Y
LB-9048	reboot-HMI protection	R/W	R/Y	R/Y
LB-9062	open hardware setting dialog (set ON)	W	Y	Y
LB-9063	disable(set ON)/enable(set OFF) popping information dialog while finding an USB disk (i series support only)	R/W	R/Y	R/Y
LW-9008	(32bit-float) : battery voltage (i series supports only) *Note3	R	R	R
LW-9025	(16bit) : CPU loading (x 100%)	R	R	R
LW-9026	(16bit) : OS version (year)	R	R	R
LW-9027	(16bit) : OS version (month)	R	R	R
LW-9028	(16bit) : OS version (day)	R	R	R
LW-9040	(16bit) : backlight index *Note2	R	R	R
LW-9080	(16bit) : backlight saver time (unit : minute)	R/W	R/Y	R/Y
LW-9081	(16bit) : screen saver time (unit : minute)	R/W	R/Y	R/Y



1. After changing the settings, please reboot HMI for updating.
2. LW-9040 used together with LB-9040 ~ LB-9041 can adjust the backlight brightness with level 0 ~ 31.
3. For LW-9008, when the battery voltage level goes below 2.89V, it is recommended to replace the battery.

22.7 Local HMI Network Information

Address	Description	Read(R)/Write(W)/Control(Y)		
		Local HMI	MACRO R/Y	Remote HMI R/Y
LW-9125	(16bit) : HMI ethernet gateway 0 (machine used only)	R/W	R/Y	R/Y
LW-9126	(16bit) : HMI ethernet gateway 1 (machine used only)	R/W	R/Y	R/Y
LW-9127	(16bit) : HMI ethernet gateway 2 (machine used only)	R/W	R/Y	R/Y
LW-9128	(16bit) : HMI ethernet gateway 3 (machine used only)	R/W	R/Y	R/Y
LW-9129	(16bit) : HMI ethernet IP 0 (machine used only)	R/W	R/Y	R/Y
LW-9130	(16bit) : HMI ethernet IP 1 (machine used only)	R/W	R/Y	R/Y
LW-9131	(16bit) : HMI ethernet IP 2 (machine used only)	R/W	R/Y	R/Y
LW-9132	(16bit) : HMI ethernet IP 3 (machine used only)	R/W	R/Y	R/Y
LW-9133	(16bit) : ethernet port no.	R	R	R
LW-9135	(16bit) : media access control (MAC) address 0	R	R	R
LW-9136	(16bit) : media access control (MAC) address 1	R	R	R
LW-9137	(16bit) : media access control (MAC) address 2	R	R	R
LW-9138	(16bit) : media access control (MAC) address 3	R	R	R
LW-9139	(16bit) : media access control (MAC) address 4	R	R	R
LW-9140	(16bit) : media access control (MAC) address 5	R	R	R
LW-1075 0	(16bit) : HMI ethernet Mask 0 (machine used only)	R/W	R/Y	R/Y
LW-1075 1	(16bit) : HMI ethernet Mask 0 (machine used only)	R/W	R/Y	R/Y
LW-1075 2	(16bit) : HMI ethernet Mask 0 (machine used only)	R/W	R/Y	R/Y
LW-1075 3	(16bit) : HMI ethernet Mask 0 (machine used only)	R/W	R/Y	R/Y

22.8 Recipe and Extended Memory

Address	Description	Read(R)/Write(W)/Control(Y)		
		Local HMI	MACRO R/Y	Remote HMI R/Y
LB-9028	reset all recipe data (set ON)	W	Y	Y
LB-9029	save all recipe data to machine (set ON)	W	Y	Y
LB-9460	EM0's storage device (SD card) does not exist (when ON)	R	R	R
LB-9461	EM1's storage device (SD card) does not exist (when ON)	R	R	R
LB-9462	EM2's storage device (SD card) does not exist (when ON)	R	R	R
LB-9463	EM3's storage device (SD card) does not exist (when ON)	R	R	R
LB-9464	EM4's storage device (SD card) does not exist (when ON)	R	R	R
LB-9465	EM5's storage device (SD card) does not exist (when ON)	R	R	R
LB-9466	EM6's storage device (SD card) does not exist (when ON)	R	R	R
LB-9467	EM7's storage device (SD card) does not exist (when ON)	R	R	R
LB-9468	EM8's storage device (SD card) does not exist (when ON)	R	R	R
LB-9469	EM9's storage device (SD card) does not exist (when ON)	R	R	R
LB-9470	EM0's storage device (USB1 disk) does not exist (when ON)	R	R	R
LB-9471	EM1's storage device (USB1 disk) does not exist (when ON)	R	R	R
LB-9472	EM2's storage device (USB1 disk) does not exist (when ON)	R	R	R
LB-9473	EM3's storage device (USB1 disk) does not exist (when ON)	R	R	R
LB-9474	EM4's storage device (USB1 disk) does not exist (when ON)	R	R	R
LB-9475	EM5's storage device (USB1 disk) does not	R	R	R

	exist (when ON)			
LB-9476	EM6's storage device (USB1 disk) does not exist (when ON)	R	R	R
LB-9477	EM7's storage device (USB1 disk) does not exist (when ON)	R	R	R
LB-9478	EM8's storage device (USB1 disk) does not exist (when ON)	R	R	R
LB-9479	EM9's storage device (USB1 disk) does not exist (when ON)	R	R	R
LB-9480	EM0's storage device (USB2 disk) does not exist (when ON)	R	R	R
LB-9481	EM1's storage device (USB2 disk) does not exist (when ON)	R	R	R
LB-9482	EM2's storage device (USB2 disk) does not exist (when ON)	R	R	R
LB-9483	EM3's storage device (USB2 disk) does not exist (when ON)	R	R	R
LB-9484	EM4's storage device (USB2 disk) does not exist (when ON)	R	R	R
LB-9485	EM5's storage device (USB2 disk) does not exist (when ON)	R	R	R
LB-9486	EM6's storage device (USB2 disk) does not exist (when ON)	R	R	R
LB-9487	EM7's storage device (USB2 disk) does not exist (when ON)	R	R	R
LB-9488	EM8's storage device (USB2 disk) does not exist (when ON)	R	R	R
LB-9489	EM9's storage device (USB2 disk) does not exist (when ON)	R	R	R

22.9 Storage Space Management

Address	Description	Read(R)/Write(W)/Control(Y)		
		Local HMI	MACRO R/Y	Remote HMI R/Y
LB-9035	HMI free space insufficiency alarm (when ON)	R	R	R
LB-9036	SD card free space insufficiency alarm (when ON)	R	R	R
LB-9037	USB 1 free space insufficiency alarm (when ON)	R	R	R
LB-9038	USB 2 free space insufficiency alarm (when ON)	R	R	R
LW-9070	(16bit) : free space insufficiency warning (Mega bytes)	R	R	R
LW-9071	(16bit) : reserved free space size (K bytes)	R	R	R
LW-9072	(32bit) : HMI current free space (K bytes)	R	R	R
LW-9074	(32bit) : SD current free space (K bytes)	R	R	R
LW-9076	(32bit) : USB 1 current free space (K bytes)	R	R	R
LW-9078	(32bit) : USB 2 current free space (K bytes)	R	R	R

Want to know how to use LW-9072 ~ LW-9078 together with Backup object?



Please confirm your Internet connection before downloading the demo project.

22.10 Touch Position

Address	Description	Read(R)/Write(W)/Control(Y)		
		Local HMI	MACRO R/Y	Remote HMI R/Y
LW-9041	(16bit) : touch status word(bit 0 on = user is touching the screen)	R	R	R
LW-9042	(16bit) : touch x position	R	R	R
LW-9043	(16bit) : touch y position	R	R	R
LW-9044	(16bit) : leave x position	R	R	R
LW-9045	(16bit) : leave y position	R	R	R

Want to know how to trigger relevant registers to change window with finger slide?



Please confirm your Internet connection before downloading the demo project.

22.11 Station Number Variables

Address	Description	Read(R)/Write(W)/Control(Y)		
		Local HMI	MACRO R/Y	Remote HMI R/Y
LW-10000	(16bit) : var0 - station no variable (usage : var0#address)	R/W	R/Y	R/Y
LW-10001	(16bit) : var1 - station no variable (usage : var1#address)	R/W	R/Y	R/Y
LW-10002	(16bit) : var2 - station no variable (usage : var2#address)	R/W	R/Y	R/Y
LW-10003	(16bit) : var3 - station no variable (usage : var3#address)	R/W	R/Y	R/Y
LW-10004	(16bit) : var4 - station no variable (usage : var4#address)	R/W	R/Y	R/Y
LW-10005	(16bit) : var5 - station no variable (usage : var5#address)	R/W	R/Y	R/Y
LW-10006	(16bit) : var6 - station no variable (usage : var6#address)	R/W	R/Y	R/Y
LW-10007	(16bit) : var7 - station no variable (usage : var7#address)	R/W	R/Y	R/Y
LW-10008	(16bit) : var8 - station no variable (usage : var8#address)	R/W	R/Y	R/Y
LW-10009	(16bit) : var9 - station no variable (usage : var9#address)	R/W	R/Y	R/Y
LW-10010	(16bit) : var10 - station no variable (usage : var10#address)	R/W	R/Y	R/Y
LW-10011	(16bit) : var11 - station no variable (usage : var11#address)	R/W	R/Y	R/Y
LW-10012	(16bit) : var12 - station no variable (usage : var12#address)	R/W	R/Y	R/Y
LW-10013	(16bit) : var13 - station no variable (usage : var13#address)	R/W	R/Y	R/Y
LW-10014	(16bit) : var14 - station no variable (usage : var14#address)	R/W	R/Y	R/Y
LW-10015	(16bit) : var15 - station no variable (usage : var15#address)	R/W	R/Y	R/Y



Please confirm your Internet connection before downloading the demo project.

22.12 Index Register

Address	Description	Read(R)/Write(W)/Control(Y)		
		Local HMI	MACRO R/Y	Remote HMI R/Y
LW-9200	(16bit) : address index 0	R/W	R/Y	R/Y
LW-9201	(16bit) : address index 1	R/W	R/Y	R/Y
LW-9202	(16bit) : address index 2	R/W	R/Y	R/Y
LW-9203	(16bit) : address index 3	R/W	R/Y	R/Y
LW-9204	(16bit) : address index 4	R/W	R/Y	R/Y
LW-9205	(16bit) : address index 5	R/W	R/Y	R/Y
LW-9206	(16bit) : address index 6	R/W	R/Y	R/Y
LW-9207	(16bit) : address index 7	R/W	R/Y	R/Y
LW-9208	(16bit) : address index 8	R/W	R/Y	R/Y
LW-9209	(16bit) : address index 9	R/W	R/Y	R/Y
LW-9210	(16bit) : address index 10	R/W	R/Y	R/Y
LW-9211	(16bit) : address index 11	R/W	R/Y	R/Y
LW-9212	(16bit) : address index 12	R/W	R/Y	R/Y
LW-9213	(16bit) : address index 13	R/W	R/Y	R/Y
LW-9214	(16bit) : address index 14	R/W	R/Y	R/Y
LW-9215	(16bit) : address index 15	R/W	R/Y	R/Y
LW-9230	(32bit) : address index 16	R/W	R/Y	R/Y
LW-9232	(32bit) : address index 17	R/W	R/Y	R/Y
LW-9234	(32bit) : address index 18	R/W	R/Y	R/Y
LW-9236	(32bit) : address index 19	R/W	R/Y	R/Y
LW-9238	(32bit) : address index 20	R/W	R/Y	R/Y
LW-9240	(32bit) : address index 21	R/W	R/Y	R/Y
LW-9242	(32bit) : address index 22	R/W	R/Y	R/Y
LW-9244	(32bit) : address index 23	R/W	R/Y	R/Y
LW-9246	(32bit) : address index 24	R/W	R/Y	R/Y
LW-9248	(32bit) : address index 25	R/W	R/Y	R/Y
LW-9250	(32bit) : address index 26	R/W	R/Y	R/Y
LW-9252	(32bit) : address index 27	R/W	R/Y	R/Y
LW-9254	(32bit) : address index 28	R/W	R/Y	R/Y
LW-9256	(32bit) : address index 29	R/W	R/Y	R/Y
LW-9258	(32bit) : address index 30	R/W	R/Y	R/Y
LW-9260	(32bit) : address index 31	R/W	R/Y	R/Y

22.13 MTP File Information

Address	Description	Read(R)/Write(W)/Control(Y)		
		Local HMI	MACRO R/Y	Remote HMI R/Y
LW-9100	(16bit) : project name (16 words)	R	R	R
LW-9116	(32bit) : project size in bytes	R	R	R
LW-9118	(32bit) : project size in K bytes	R	R	R
LW-9120	(32bit) : compiler version	R	R	R
LW-9122	(16bit) : project compiled date [year]	R	R	R
LW-9123	(16bit) : project compiled date [month]	R	R	R
LW-9124	(16bit) : project compiled date [day]	R	R	R

22.14 MODBUS Server Communication

Address	Description	Read(R)/Write(W)/Control(Y)		
		Local HMI	MACRO R/Y	Remote HMI R/Y
LB-9055	MODBUS server (COM 1) receives a request (when ON)	R	R	R
LB-9056	MODBUS server (COM 2) receives a request (when ON)	R	R	R
LB-9057	MODBUS server (COM 3) receives a request (when ON)	R	R	R
LB-9058	MODBUS server (ethernet) receives a request (when ON)	R	R	R
LW-9270	(16bit) : request's function code - MODBUS server (COM 1)	R	R	R
LW-9271	(16bit) : request's starting address - MODBUS server (COM 1)	R	R	R
LW-9272	(16bit) : request's quantity of registers - MODBUS server (COM 1)	R	R	R
LW-9275	(16bit) : request's function code - MODBUS server (COM 2)	R	R	R
LW-9276	(16bit) : request's starting address - MODBUS server (COM 2)	R	R	R
LW-9277	(16bit) : request's quantity of registers - MODBUS server (COM 2)	R	R	R
LW-9280	(16bit) : request's function code - MODBUS server (COM 3)	R	R	R
LW-9281	(16bit) : request's starting address - MODBUS server (COM 3)	R	R	R
LW-9282	(16bit) : request's quantity of registers - MODBUS server (COM 3)	R	R	R
LW-9285	(16bit) : request's function code - MODBUS server (ethernet)	R	R	R
LW-9286	(16bit) : request's starting address - MODBUS server (ethernet)	R	R	R
LW-9287	(16bit) : request's quantity of registers - MODBUS server (ethernet)	R	R	R
LW-9541	(16bit) : MODBUS/ASCII server station no.	R/W	R/Y	R/Y

	(COM 1)			
LW-9542	(16bit) : MODBUS/ASCII server station no. (COM 2)	R/W	R/Y	R/Y
LW-9543	(16bit) : MODBUS/ASCII server station no. (COM 3)	R/W	R/Y	R/Y
LW-9544	(16bit) : MODBUS/ASCII server station no. (ethernet)	R/W	R/Y	R/Y
LW-9570	(32bit) : received data count (bytes) (COM 1 MODBUS server)	R	R	R
LW-9572	(32bit) : received data count (bytes) (COM 2 MODBUS server)	R	R	R
LW-9574	(32bit) : received data count (bytes) (COM 3 MODBUS server)	R	R	R
LW-9576	(32bit) : received data count (bytes) (Ethernet MODBUS server)	R	R	R

22.15 Communication Parameters Settings

Address	Description	Read(R)/Write(W)/Control(Y)		
		Local HMI	MACRO R/Y	Remote HMI R/Y
LB-9030	update COM 1 communication parameters (set ON)	R/W	R/Y	R/Y
LB-9031	update COM 2 communication parameters (set ON)	R/W	R/Y	R/Y
LB-9032	update COM 3 communication parameters (set ON)	R/W	R/Y	R/Y
LB-9065	disable/enable COM1 broadcast station no.	R/W	R/Y	R/Y
LB-9066	disable/enable COM2 broadcast station no.	R/W	R/Y	R/Y
LB-9067	disable/enable COM3 broadcast station no.	R/W	R/Y	R/Y
LW-9550	(16bit) : COM 1 mode(0:RS232,1:RS485 2W,2:RS485 4W)	R/W	R/Y	R/Y
LW-9551	(16bit) : COM 1 baud rate(7:1200,8:2400,0:4800,1:9600,2:19200,3:38400,4:57600,..)	R/W	R/Y	R/Y
LW-9552	(16bit) : COM 1 databits (7 : 7 bits, 8 : 8 bits)	R/W	R/Y	R/Y
LW-9553	(16bit) : COM 1 parity (0:none, 1:even, 2:odd, 3:mark, 4:space)	R/W	R/Y	R/Y
LW-9554	(16bit) : COM 1 stop bits (1 : 1 bit, 2 : 2 bits)	R/W	R/Y	R/Y
LW-9555	(16bit) : COM 2 mode(0:RS232,1:RS485 2W,2:RS485 4W)	R/W	R/Y	R/Y
LW-9556	(16bit) : COM 2 baud rate(7:1200,8:2400,0:4800,1:9600,2:19200,3:38400,4:57600,..)	R/W	R/Y	R/Y
LW-9557	(16bit) : COM 2 databits (7 : 7 bits, 8 : 8 bits)	R/W	R/Y	R/Y
LW-9558	(16bit) : COM 2 parity (0:none, 1:even, 2:odd, 3:mark, 4:space)	R/W	R/Y	R/Y
LW-9559	(16bit) : COM 2 stop bits (1 : 1 bit, 2 : 2 bits)	R/W	R/Y	R/Y
LW-9560	(16bit) : COM 3 mode(0:RS232,1:RS485 2W)	R/W	R/Y	R/Y
LW-9561	(16bit) : COM 3 baud rate(7:1200,8:2400,0:4800,1:9600,2:19200,3:38400,4:57600,..)	R/W	R/Y	R/Y
LW-9562	(16bit) : COM 3 databits (7 : 7 bits, 8 : 8 bits)	R/W	R/Y	R/Y
LW-9563	(16bit) : COM 3 parity (0:none, 1:even, 2:odd,	R/W	R/Y	R/Y

	3:mark, 4:space)			
LW-9564	(16bit) : COM 3 stop bits (1 : 1 bit, 2 : 2 bits)	R/W	R/Y	R/Y
LW-9565	(16bit) : COM 1 broadcast station no.	R/W	R/Y	R/Y
LW-9566	(16bit) : COM 2 broadcast station no.	R/W	R/Y	R/Y
LW-9567	(16bit) : COM 3 broadcast station no.	R/W	R/Y	R/Y
LW-10500	(16bit) : PLC 1 timeout (unit : 100ms)	R/W	R/Y	R/Y
LW-10501	(16bit) : PLC 1 turn around delay (unit : ms)	R/W	R/Y	R/Y
LW-10502	(16bit) : PLC 1 send ACK delay (unit : ms)	R/W	R/Y	R/Y
LW-10503	(16bit) : PLC 1 parameter 1	R/W	R/Y	R/Y
LW-10504	(16bit) : PLC 1 parameter 2	R/W	R/Y	R/Y
LW-10505	(16bit) : PLC 2 timeout (unit : 100ms)	R/W	R/Y	R/Y
LW-10506	(16bit) : PLC 2 turn around delay (unit : ms)	R/W	R/Y	R/Y
LW-10507	(16bit) : PLC 2 send ACK delay (unit : ms)	R/W	R/Y	R/Y
LW-10508	(16bit) : PLC 2 parameter 1	R/W	R/Y	R/Y
LW-10509	(16bit) : PLC 2 parameter 2	R/W	R/Y	R/Y
LW-10510	(16bit) : PLC 3 timeout (unit : 100ms)	R/W	R/Y	R/Y
LW-10511	(16bit) : PLC 3 turn around delay (unit : ms)	R/W	R/Y	R/Y
LW-10512	(16bit) : PLC 3 send ACK delay (unit : ms)	R/W	R/Y	R/Y
LW-10513	(16bit) : PLC 3 parameter 1	R/W	R/Y	R/Y
LW-10514	(16bit) : PLC 3 parameter 2	R/W	R/Y	R/Y
LW-10515	(16bit) : PLC 4 timeout (unit : 100ms)	R/W	R/Y	R/Y
LW-10516	(16bit) : PLC 4 turn around delay (unit : ms)	R/W	R/Y	R/Y
LW-10517	(16bit) : PLC 4 send ACK delay (unit : ms) (SIEMENS S7/400 Link type)	R/W	R/Y	R/Y
LW-10518	(16bit) : PLC 4 parameter 1 (SIEMENS S7/400 rack)	R/W	R/Y	R/Y
LW-10519	(16bit) : PLC 4 parameter 2 (SIEMENS S7/400 CPU slot)	R/W	R/Y	R/Y
LW-10520	(16bit) : PLC 5 timeout (unit : 100ms)	R/W	R/Y	R/Y
LW-10521	(16bit) : PLC 5 turn around delay (unit : ms)	R/W	R/Y	R/Y
LW-10522	(16bit) : PLC 5 send ACK delay (unit : ms) (SIEMENS S7/400 Link type)	R/W	R/Y	R/Y
LW-10523	(16bit) : PLC 5 parameter 1 (SIEMENS S7/400 rack)	R/W	R/Y	R/Y
LW-10524	(16bit) : PLC 5 parameter 2 (SIEMENS S7/400 CPU slot)	R/W	R/Y	R/Y
LW-10525	(16bit) : PLC 6 timeout (unit : 100ms)	R/W	R/Y	R/Y

LW-10526	(16bit) : PLC 6 turn around delay (unit : ms)	R/W	R/Y	R/Y
LW-10527	(16bit) : PLC 6 send ACK delay (unit : ms) (SIEMENS S7/400 Link type)	R/W	R/Y	R/Y
LW-10528	(16bit) : PLC 6 parameter 1 (SIEMENS S7/400 rack)	R/W	R/Y	R/Y
LW-10529	(16bit) : PLC 6 parameter 2 (SIEMENS S7/400 CPU slot)	R/W	R/Y	R/Y
LW-10530	(16bit) : PLC 7 timeout (unit : 100ms)	R/W	R/Y	R/Y
LW-10531	(16bit) : PLC 7 turn around delay (unit : ms)	R/W	R/Y	R/Y
LW-10532	(16bit) : PLC 7 send ACK delay (unit : ms) (SIEMENS S7/400 Link type)	R/W	R/Y	R/Y
LW-10533	(16bit) : PLC 7 parameter 1 (SIEMENS S7/400 rack)	R/W	R/Y	R/Y
LW-10534	(16bit) : PLC 7 parameter 2 (SIEMENS S7/400 CPU slot)	R/W	R/Y	R/Y
LW-10535	(16bit) : PLC 8 timeout (unit : 100ms)	R/W	R/Y	R/Y
LW-10536	(16bit) : PLC 8 turn around delay (unit : ms)	R/W	R/Y	R/Y
LW-10537	(16bit) : PLC 8 send ACK delay (unit : ms) (SIEMENS S7/400 Link type)	R/W	R/Y	R/Y
LW-10538	(16bit) : PLC 8 parameter 1 (SIEMENS S7/400 rack)	R/W	R/Y	R/Y
LW-10539	(16bit) : PLC 8 parameter 2 (SIEMENS S7/400 CPU slot)	R/W	R/Y	R/Y

22.16 Communication Status with PLC (COM)

Address	Description	Read(R)/Write(W)/Control(Y)		
		Local HMI	MACRO R/Y	Remote HMI R/Y
LB-9150	auto. connection for PLC 1 (COM1) (when ON)	R/W	R/Y	R/Y
LB-9151	auto. connection for PLC 2 (COM2) (when ON)	R/W	R/Y	R/Y
LB-9152	auto. connection for PLC 3 (COM3) (when ON)	R/W	R/Y	R/Y
LB-9200	PLC 1 status (SN0, COM1), set on to retry connection	R/W	R/Y	R/Y
LB-9201	PLC 1 status (SN1, COM1), set on to retry connection	R/W	R/Y	R/Y
LB-9202	PLC 1 status (SN2, COM1), set on to retry connection	R/W	R/Y	R/Y
LB-9203	PLC 1 status (SN3, COM1), set on to retry connection	R/W	R/Y	R/Y
LB-9204	PLC 1 status (SN4, COM1), set on to retry connection	R/W	R/Y	R/Y
LB-9205	PLC 1 status (SN5, COM1), set on to retry connection	R/W	R/Y	R/Y
LB-9206	PLC 1 status (SN6, COM1), set on to retry connection	R/W	R/Y	R/Y
LB-9207	PLC 1 status (SN7, COM1), set on to retry connection	R/W	R/Y	R/Y
LB-9500	PLC 2 status (SN0, COM2), set on to retry connection	R/W	R/Y	R/Y
LB-9501	PLC 2 status (SN1, COM2), set on to retry connection	R/W	R/Y	R/Y
LB-9502	PLC 2 status (SN2, COM2), set on to retry connection	R/W	R/Y	R/Y
LB-9503	PLC 2 status (SN3, COM2), set on to retry connection	R/W	R/Y	R/Y
LB-9504	PLC 2 status (SN4, COM2), set on to retry connection	R/W	R/Y	R/Y
LB-9505	PLC 2 status (SN5, COM2), set on to retry connection	R/W	R/Y	R/Y
LB-9506	PLC 2 status (SN6, COM2), set on to retry connection	R/W	R/Y	R/Y

LB-9507	PLC 2 status (SN7, COM2), set on to retry connection	R/W	R/Y	R/Y
LB-9800	PLC 3 status (SN0, COM3), set on to retry connection	R/W	R/Y	R/Y
LB-9801	PLC 3 status (SN1, COM3), set on to retry connection	R/W	R/Y	R/Y
LB-9802	PLC 3 status (SN2, COM3), set on to retry connection	R/W	R/Y	R/Y
LB-9803	PLC 3 status (SN3, COM3), set on to retry connection	R/W	R/Y	R/Y
LB-9804	PLC 3 status (SN4, COM3), set on to retry connection	R/W	R/Y	R/Y
LB-9805	PLC 3 status (SN5, COM3), set on to retry connection	R/W	R/Y	R/Y
LB-9806	PLC 3 status (SN6, COM3), set on to retry connection	R/W	R/Y	R/Y
LB-9807	PLC 3 status (SN7, COM3), set on to retry connection	R/W	R/Y	R/Y

22.17 Communication Status with PLC (Ethernet)

Address	Description	Read(R)/Write(W)/Control(Y)		
		Local HMI	MACRO R/Y	Remote HMI R/Y
LB-9153	auto. connection for PLC 4 (ethernet) (when ON)	R/W	R/Y	R/Y
LB-9154	auto. connection for PLC 5 (ethernet) (when ON)	R/W	R/Y	R/Y
LB-9155	auto. connection for PLC 6 (ethernet) (when ON)	R/W	R/Y	R/Y
LB-9156	auto. connection for PLC 7 (ethernet) (when ON)	R/W	R/Y	R/Y
LB-9157	auto. connection for PLC 8 (ethernet) (when ON)	R/W	R/Y	R/Y
LB-9158	auto. connection for PLC 9 (ethernet) (when ON)	R/W	R/Y	R/Y
LB-10070	forced to reconnect PLC 4 (ethernet) when IP or system parameters changed on-line (set ON)	R/W	R/Y	R/Y
LB-10071	forced to reconnect PLC 5 (ethernet) when IP or system parameters changed on-line (set ON)	R/W	R/Y	R/Y
LB-10072	forced to reconnect PLC 6 (ethernet) when IP or system parameters changed on-line (set ON)	R/W	R/Y	R/Y
LB-10073	forced to reconnect PLC 7 (ethernet) when IP or system parameters changed on-line (set ON)	R/W	R/Y	R/Y
LB-10074	forced to reconnect PLC 8 (ethernet) when IP or system parameters changed on-line (set ON)	R/W	R/Y	R/Y
LB-10075	forced to reconnect PLC 9 (ethernet) when IP or system parameters changed on-line (set ON)	R/W	R/Y	R/Y
LB-10100	PLC 4 status (ethernet), set on to retry connection	R/W	R/Y	R/Y
LB-10400	PLC 5 status (ethernet), set on to retry	R/W	R/Y	R/Y

	connection			
LB-10700	PLC 6 status (ethernet), set on to retry connection	R/W	R/Y	R/Y
LB-11000	PLC 7 status (ethernet), set on to retry connection	R/W	R/Y	R/Y
LB-11300	PLC 8 status (ethernet), set on to retry connection	R/W	R/Y	R/Y
LB-11600	PLC 9 status (ethernet), set on to retry connection	R/W	R/Y	R/Y
LB-11900	PLC 10 status (ethernet), set on to retry connection	R/W	R/Y	R/Y
LB-11901	PLC 11 status (ethernet), set on to retry connection	R/W	R/Y	R/Y
LB-11902	PLC 12 status (ethernet), set on to retry connection	R/W	R/Y	R/Y
LB-11903	PLC 13 status (ethernet), set on to retry connection	R/W	R/Y	R/Y
LB-11904	PLC 14 status (ethernet), set on to retry connection	R/W	R/Y	R/Y
LB-11905	PLC 15 status (ethernet), set on to retry connection	R/W	R/Y	R/Y
LB-11906	PLC 16 status (ethernet), set on to retry connection	R/W	R/Y	R/Y
LW-9600	(16bit) : PLC 4's IP0 (IP address = IP0:IP1:IP2:IP3)	R/W	R/Y	R/Y
LW-9601	(16bit) : PLC 4's IP1 (IP address = IP0:IP1:IP2:IP3)	R/W	R/Y	R/Y
LW-9602	(16bit) : PLC 4's IP2 (IP address = IP0:IP1:IP2:IP3)	R/W	R/Y	R/Y
LW-9603	(16bit) : PLC 4's IP3 (IP address = IP0:IP1:IP2:IP3)	R/W	R/Y	R/Y
LW-9604	(16bit) : PLC 4's port no.	R/W	R/Y	R/Y
LW-9605	(16bit) : PLC 5's IP0 (IP address = IP0:IP1:IP2:IP3)	R/W	R/Y	R/Y
LW-9606	(16bit) : PLC 5's IP1 (IP address = IP0:IP1:IP2:IP3)	R/W	R/Y	R/Y
LW-9607	(16bit) : PLC 5's IP2 (IP address = IP0:IP1:IP2:IP3)	R/W	R/Y	R/Y

LW-9608	(16bit) : PLC 5's IP3 (IP address = IP0:IP1:IP2:IP3)	R/W	R/Y	R/Y
LW-9609	(16bit) : PLC 5's port no.	R/W	R/Y	R/Y
LW-9610	(16bit) : PLC 6's IP0 (IP address = IP0:IP1:IP2:IP3)	R/W	R/Y	R/Y
LW-9611	(16bit) : PLC 6's IP1 (IP address = IP0:IP1:IP2:IP3)	R/W	R/Y	R/Y
LW-9612	(16bit) : PLC 6's IP2 (IP address = IP0:IP1:IP2:IP3)	R/W	R/Y	R/Y
LW-9613	(16bit) : PLC 6's IP3 (IP address = IP0:IP1:IP2:IP3)	R/W	R/Y	R/Y
LW-9614	(16bit) : PLC 6's port no.	R/W	R/Y	R/Y
LW-9615	(16bit) : PLC 7's IP0 (IP address = IP0:IP1:IP2:IP3)	R/W	R/Y	R/Y
LW-9616	(16bit) : PLC 7's IP1 (IP address = IP0:IP1:IP2:IP3)	R/W	R/Y	R/Y
LW-9617	(16bit) : PLC 7's IP2 (IP address = IP0:IP1:IP2:IP3)	R/W	R/Y	R/Y
LW-9618	(16bit) : PLC 7's IP3 (IP address = IP0:IP1:IP2:IP3)	R/W	R/Y	R/Y
LW-9619	(16bit) : PLC 7's port no.	R/W	R/Y	R/Y
LW-9620	(16bit) : PLC 8's IP0 (IP address = IP0:IP1:IP2:IP3)	R/W	R/Y	R/Y
LW-9621	(16bit) : PLC 8's IP1 (IP address = IP0:IP1:IP2:IP3)	R/W	R/Y	R/Y
LW-9622	(16bit) : PLC 8's IP2 (IP address = IP0:IP1:IP2:IP3)	R/W	R/Y	R/Y
LW-9623	(16bit) : PLC 8's IP3 (IP address = IP0:IP1:IP2:IP3)	R/W	R/Y	R/Y
LW-9624	(16bit) : PLC 8's port no.	R/W	R/Y	R/Y
LW-9625	(16bit) : PLC 9's IP0 (IP address = IP0:IP1:IP2:IP3)	R/W	R/Y	R/Y
LW-9626	(16bit) : PLC 9's IP1 (IP address = IP0:IP1:IP2:IP3)	R/W	R/Y	R/Y
LW-9627	(16bit) : PLC 9's IP2 (IP address = IP0:IP1:IP2:IP3)	R/W	R/Y	R/Y
LW-9628	(16bit) : PLC 9's IP3 (IP address = IP0:IP1:IP2:IP3)	R/W	R/Y	R/Y

LW-9629	(16bit) : PLC 9's port no.	R/W	R/Y	R/Y
---------	----------------------------	-----	-----	-----

22.18 Communication Status with PLC (USB)

Address	Description	Read(R)/Write(W)/Control(Y)		
		Local HMI	MACRO R/Y	Remote HMI R/Y
LB-9190	auto. connection for PLC (USB 1) (when ON)	R/W	R/Y	R/Y
LB-9191	PLC status (USB 1), set on to retry connection	R/W	R/Y	R/Y
LB-9193	auto. connection for PLC (USB 2) (when ON)	R/W	R/Y	R/Y
LB-9194	PLC status (USB 2), set on to retry connection	R/W	R/Y	R/Y

22.19 Communication Status with Remote HMI

Address	Description	Read(R)/Write(W)/Control(Y)		
		Local HMI	MACRO R/Y	Remote HMI R/Y
LB-9068	auto. connection for remote HMI 1 (when ON)	R/W	R/Y	R/Y
LB-9069	auto. connection for remote HMI 2 (when ON)	R/W	R/Y	R/Y
LB-9070	auto. connection for remote HMI 3 (when ON)	R/W	R/Y	R/Y
LB-9071	auto. connection for remote HMI 4 (when ON)	R/W	R/Y	R/Y
LB-9072	auto. connection for remote HMI 5 (when ON)	R/W	R/Y	R/Y
LB-9073	auto. connection for remote HMI 6 (when ON)	R/W	R/Y	R/Y
LB-9074	auto. connection for remote HMI 7 (when ON)	R/W	R/Y	R/Y
LB-9075	auto. connection for remote HMI 8 (when ON)	R/W	R/Y	R/Y
LB-9100	remote HMI 1 status (set on to retry connection)	R/W	R/Y	R/Y
LB-9101	remote HMI 2 status (set on to retry connection)	R/W	R/Y	R/Y
LB-9102	remote HMI 3 status (set on to retry connection)	R/W	R/Y	R/Y
LB-9103	remote HMI 4 status (set on to retry connection)	R/W	R/Y	R/Y
LB-9104	remote HMI 5 status (set on to retry connection)	R/W	R/Y	R/Y
LB-9105	remote HMI 6 status (set on to retry connection)	R/W	R/Y	R/Y
LB-9106	remote HMI 7 status (set on to retry connection)	R/W	R/Y	R/Y
LB-9107	remote HMI 8 status (set on to retry connection)	R/W	R/Y	R/Y
LB-9149	forced to reconnect remote HMI when IP changed on-line (set ON)	R/W	R/Y	R/Y
LW-9800	(16bit) : remote HMI 1's IP0 (IP address = IP0:IP1:IP2:IP3)	R/W	R/Y	R/Y
LW-9801	(16bit) : remote HMI 1's IP1 (IP address = IP0:IP1:IP2:IP3)	R/W	R/Y	R/Y
LW-9802	(16bit) : remote HMI 1's IP2 (IP address = IP0:IP1:IP2:IP3)	R/W	R/Y	R/Y
LW-9803	(16bit) : remote HMI 1's IP3 (IP address =	R/W	R/Y	R/Y

	IP0:IP1:IP2:IP3)			
LW-9804	(16bit) : remote HMI 1's port no.	R/W	R/Y	R/Y
LW-9805	(16bit) : remote HMI 2's IP0 (IP address = IP0:IP1:IP2:IP3)	R/W	R/Y	R/Y
LW-9806	(16bit) : remote HMI 2's IP1 (IP address = IP0:IP1:IP2:IP3)	R/W	R/Y	R/Y
LW-9807	(16bit) : remote HMI 2's IP2 (IP address = IP0:IP1:IP2:IP3)	R/W	R/Y	R/Y
LW-9808	(16bit) : remote HMI 2's IP3 (IP address = IP0:IP1:IP2:IP3)	R/W	R/Y	R/Y
LW-9809	(16bit) : remote HMI 2's port no.	R/W	R/Y	R/Y
LW-9810	(16bit) : remote HMI 3's IP0 (IP address = IP0:IP1:IP2:IP3)	R/W	R/Y	R/Y
LW-9811	(16bit) : remote HMI 3's IP1 (IP address = IP0:IP1:IP2:IP3)	R/W	R/Y	R/Y
LW-9812	(16bit) : remote HMI 3's IP2 (IP address = IP0:IP1:IP2:IP3)	R/W	R/Y	R/Y
LW-9813	(16bit) : remote HMI 3's IP3 (IP address = IP0:IP1:IP2:IP3)	R/W	R/Y	R/Y
LW-9814	(16bit) : remote HMI 3's port no.	R/W	R/Y	R/Y
LW-9815	(16bit) : remote HMI 4's IP0 (IP address = IP0:IP1:IP2:IP3)	R/W	R/Y	R/Y
LW-9816	(16bit) : remote HMI 4's IP1 (IP address = IP0:IP1:IP2:IP3)	R/W	R/Y	R/Y
LW-9817	(16bit) : remote HMI 4's IP2 (IP address = IP0:IP1:IP2:IP3)	R/W	R/Y	R/Y
LW-9818	(16bit) : remote HMI 4's IP3 (IP address = IP0:IP1:IP2:IP3)	R/W	R/Y	R/Y
LW-9819	(16bit) : remote HMI 4's port no.	R/W	R/Y	R/Y
LW-9820	(16bit) : remote HMI 5's IP0 (IP address = IP0:IP1:IP2:IP3)	R/W	R/Y	R/Y
LW-9821	(16bit) : remote HMI 5's IP1 (IP address = IP0:IP1:IP2:IP3)	R/W	R/Y	R/Y
LW-9822	(16bit) : remote HMI 5's IP2 (IP address = IP0:IP1:IP2:IP3)	R/W	R/Y	R/Y
LW-9823	(16bit) : remote HMI 5's IP3 (IP address = IP0:IP1:IP2:IP3)	R/W	R/Y	R/Y
LW-9824	(16bit) : remote HMI 5's port no.	R/W	R/Y	R/Y

LW-9825	(16bit) : remote HMI 6's IP0 (IP address = IP0:IP1:IP2:IP3)	R/W	R/Y	R/Y
LW-9826	(16bit) : remote HMI 6's IP1 (IP address = IP0:IP1:IP2:IP3)	R/W	R/Y	R/Y
LW-9827	(16bit) : remote HMI 6's IP2 (IP address = IP0:IP1:IP2:IP3)	R/W	R/Y	R/Y
LW-9828	(16bit) : remote HMI 6's IP3 (IP address = IP0:IP1:IP2:IP3)	R/W	R/Y	R/Y
LW-9829	(16bit) : remote HMI 6's port no.	R/W	R/Y	R/Y
LW-9830	(16bit) : remote HMI 7's IP0 (IP address = IP0:IP1:IP2:IP3)	R/W	R/Y	R/Y
LW-9831	(16bit) : remote HMI 7's IP1 (IP address = IP0:IP1:IP2:IP3)	R/W	R/Y	R/Y
LW-9832	(16bit) : remote HMI 7's IP2 (IP address = IP0:IP1:IP2:IP3)	R/W	R/Y	R/Y
LW-9833	(16bit) : remote HMI 7's IP3 (IP address = IP0:IP1:IP2:IP3)	R/W	R/Y	R/Y
LW-9834	(16bit) : remote HMI 7's port no.	R/W	R/Y	R/Y
LW-9835	(16bit) : remote HMI 8's IP0 (IP address = IP0:IP1:IP2:IP3)	R/W	R/Y	R/Y
LW-9836	(16bit) : remote HMI 8's IP1 (IP address = IP0:IP1:IP2:IP3)	R/W	R/Y	R/Y
LW-9837	(16bit) : remote HMI 8's IP2 (IP address = IP0:IP1:IP2:IP3)	R/W	R/Y	R/Y
LW-9838	(16bit) : remote HMI 8's IP3 (IP address = IP0:IP1:IP2:IP3)	R/W	R/Y	R/Y
LW-9839	(16bit) : remote HMI 8's port no.	R/W	R/Y	R/Y
LW-9905	(16bit) : remote HMI 21's IP0 (IP address = IP0:IP1:IP2:IP3)	R/W	R/Y	R/Y
LW-9906	(16bit) : remote HMI 21's IP1 (IP address = IP0:IP1:IP2:IP3)	R/W	R/Y	R/Y
LW-9907	(16bit) : remote HMI 21's IP2 (IP address = IP0:IP1:IP2:IP3)	R/W	R/Y	R/Y
LW-9908	(16bit) : remote HMI 21's IP3 (IP address = IP0:IP1:IP2:IP3)	R/W	R/Y	R/Y
LW-9909	(16bit) : remote HMI 21's port no.	R/W	R/Y	R/Y
LW-9910	(16bit) : remote HMI 22's IP0 (IP address = IP0:IP1:IP2:IP3)	R/W	R/Y	R/Y

LW-9911	(16bit) : remote HMI 22's IP1 (IP address = IP0:IP1:IP2:IP3)	R/W	R/Y	R/Y
LW-9912	(16bit) : remote HMI 22's IP2 (IP address = IP0:IP1:IP2:IP3)	R/W	R/Y	R/Y
LW-9913	(16bit) : remote HMI 22's IP3 (IP address = IP0:IP1:IP2:IP3)	R/W	R/Y	R/Y
LW-9914	(16bit) : remote HMI 22's port no.	R/W	R/Y	R/Y
LW-9915	(16bit) : remote HMI 23's IP0 (IP address = IP0:IP1:IP2:IP3)	R/W	R/Y	R/Y
LW-9916	(16bit) : remote HMI 23's IP1 (IP address = IP0:IP1:IP2:IP3)	R/W	R/Y	R/Y
LW-9917	(16bit) : remote HMI 23's IP2 (IP address = IP0:IP1:IP2:IP3)	R/W	R/Y	R/Y
LW-9918	(16bit) : remote HMI 23's IP3 (IP address = IP0:IP1:IP2:IP3)	R/W	R/Y	R/Y
LW-9919	(16bit) : remote HMI 23's port no.	R/W	R/Y	R/Y
LW-9920	(16bit) : remote HMI 24's IP0 (IP address = IP0:IP1:IP2:IP3)	R/W	R/Y	R/Y
LW-9921	(16bit) : remote HMI 24's IP1 (IP address = IP0:IP1:IP2:IP3)	R/W	R/Y	R/Y
LW-9922	(16bit) : remote HMI 24's IP2 (IP address = IP0:IP1:IP2:IP3)	R/W	R/Y	R/Y
LW-9923	(16bit) : remote HMI 24's IP3 (IP address = IP0:IP1:IP2:IP3)	R/W	R/Y	R/Y
LW-9924	(16bit) : remote HMI 24's port no.	R/W	R/Y	R/Y
LW-9925	(16bit) : remote HMI 25's IP0 (IP address = IP0:IP1:IP2:IP3)	R/W	R/Y	R/Y
LW-9926	(16bit) : remote HMI 25's IP1 (IP address = IP0:IP1:IP2:IP3)	R/W	R/Y	R/Y
LW-9927	(16bit) : remote HMI 25's IP2 (IP address = IP0:IP1:IP2:IP3)	R/W	R/Y	R/Y
LW-9928	(16bit) : remote HMI 25's IP3 (IP address = IP0:IP1:IP2:IP3)	R/W	R/Y	R/Y
LW-9929	(16bit) : remote HMI 25's port no.	R/W	R/Y	R/Y
LW-9930	(16bit) : remote HMI 26's IP0 (IP address = IP0:IP1:IP2:IP3)	R/W	R/Y	R/Y
LW-9931	(16bit) : remote HMI 26's IP1 (IP address = IP0:IP1:IP2:IP3)	R/W	R/Y	R/Y

LW-9932	(16bit) : remote HMI 26's IP2 (IP address = IP0:IP1:IP2:IP3)	R/W	R/Y	R/Y
LW-9933	(16bit) : remote HMI 26's IP3 (IP address = IP0:IP1:IP2:IP3)	R/W	R/Y	R/Y
LW-9934	(16bit) : remote HMI 26's port no.	R/W	R/Y	R/Y
LW-9935	(16bit) : remote HMI 27's IP0 (IP address = IP0:IP1:IP2:IP3)	R/W	R/Y	R/Y
LW-9936	(16bit) : remote HMI 27's IP1 (IP address = IP0:IP1:IP2:IP3)	R/W	R/Y	R/Y
LW-9937	(16bit) : remote HMI 27's IP2 (IP address = IP0:IP1:IP2:IP3)	R/W	R/Y	R/Y
LW-9938	(16bit) : remote HMI 27's IP3 (IP address = IP0:IP1:IP2:IP3)	R/W	R/Y	R/Y
LW-9939	(16bit) : remote HMI 27's port no.	R/W	R/Y	R/Y
LW-9940	(16bit) : remote HMI 28's IP0 (IP address = IP0:IP1:IP2:IP3)	R/W	R/Y	R/Y
LW-9941	(16bit) : remote HMI 28's IP1 (IP address = IP0:IP1:IP2:IP3)	R/W	R/Y	R/Y
LW-9942	(16bit) : remote HMI 28's IP2 (IP address = IP0:IP1:IP2:IP3)	R/W	R/Y	R/Y
LW-9943	(16bit) : remote HMI 28's IP3 (IP address = IP0:IP1:IP2:IP3)	R/W	R/Y	R/Y
LW-9944	(16bit) : remote HMI 28's port no.	R/W	R/Y	R/Y
LW-9945	(16bit) : remote HMI 29's IP0 (IP address = IP0:IP1:IP2:IP3)	R/W	R/Y	R/Y
LW-9946	(16bit) : remote HMI 29's IP1 (IP address = IP0:IP1:IP2:IP3)	R/W	R/Y	R/Y
LW-9947	(16bit) : remote HMI 29's IP2 (IP address = IP0:IP1:IP2:IP3)	R/W	R/Y	R/Y
LW-9948	(16bit) : remote HMI 29's IP3 (IP address = IP0:IP1:IP2:IP3)	R/W	R/Y	R/Y
LW-9949	(16bit) : remote HMI 29's port no.	R/W	R/Y	R/Y
LW-9950	(16bit) : remote HMI 30's IP0 (IP address = IP0:IP1:IP2:IP3)	R/W	R/Y	R/Y
LW-9951	(16bit) : remote HMI 30's IP1 (IP address = IP0:IP1:IP2:IP3)	R/W	R/Y	R/Y
LW-9952	(16bit) : remote HMI 30's IP2 (IP address = IP0:IP1:IP2:IP3)	R/W	R/Y	R/Y

LW-9953	(16bit) : remote HMI 30's IP3 (IP address = IP0:IP1:IP2:IP3)	R/W	R/Y	R/Y
LW-9954	(16bit) : remote HMI 30's port no.	R/W	R/Y	R/Y
LW-9955	(16bit) : remote HMI 31's IP0 (IP address = IP0:IP1:IP2:IP3)	R/W	R/Y	R/Y
LW-9956	(16bit) : remote HMI 31's IP1 (IP address = IP0:IP1:IP2:IP3)	R/W	R/Y	R/Y
LW-9957	(16bit) : remote HMI 31's IP2 (IP address = IP0:IP1:IP2:IP3)	R/W	R/Y	R/Y
LW-9958	(16bit) : remote HMI 31's IP3 (IP address = IP0:IP1:IP2:IP3)	R/W	R/Y	R/Y
LW-9959	(16bit) : remote HMI 31's port no.	R/W	R/Y	R/Y
LW-9960	(16bit) : remote HMI 32's IP0 (IP address = IP0:IP1:IP2:IP3)	R/W	R/Y	R/Y
LW-9961	(16bit) : remote HMI 32's IP1 (IP address = IP0:IP1:IP2:IP3)	R/W	R/Y	R/Y
LW-9962	(16bit) : remote HMI 32's IP2 (IP address = IP0:IP1:IP2:IP3)	R/W	R/Y	R/Y
LW-9963	(16bit) : remote HMI 32's IP3 (IP address = IP0:IP1:IP2:IP3)	R/W	R/Y	R/Y
LW-9964	(16bit) : remote HMI 32's port no.	R/W	R/Y	R/Y

22.20 Communication Status with Remote PLC

Address	Description	Read(R)/Write(W)/Control(Y)		
		Local HMI	MACRO R/Y	Remote HMI R/Y
LW-10050	(16bit) : IP0 of the HMI connecting to remote PLC 1 (IP address = IP0:IP1:IP2:IP3)	R/W	R/Y	R/Y
LW-10051	(16bit) : IP1 of the HMI connecting to remote PLC 1 (IP address = IP0:IP1:IP2:IP3)	R/W	R/Y	R/Y
LW-10052	(16bit) : IP2 of the HMI connecting to remote PLC 1 (IP address = IP0:IP1:IP2:IP3)	R/W	R/Y	R/Y
LW-10053	(16bit) : IP3 of the HMI connecting to remote PLC 1 (IP address = IP0:IP1:IP2:IP3)	R/W	R/Y	R/Y
LW-10054	(16bit) : port no. of the HMI connecting to remote PLC 1	R/W	R/Y	R/Y
LW-10055	(16bit) : IP0 of the HMI connecting to remote PLC 2 (IP address = IP0:IP1:IP2:IP3)	R/W	R/Y	R/Y
LW-10056	(16bit) : IP1 of the HMI connecting to remote PLC 2 (IP address = IP0:IP1:IP2:IP3)	R/W	R/Y	R/Y
LW-10057	(16bit) : IP2 of the HMI connecting to remote PLC 2 (IP address = IP0:IP1:IP2:IP3)	R/W	R/Y	R/Y
LW-10058	(16bit) : IP3 of the HMI connecting to remote PLC 2 (IP address = IP0:IP1:IP2:IP3)	R/W	R/Y	R/Y
LW-10059	(16bit) : port no. of the HMI connecting to remote PLC 2	R/W	R/Y	R/Y
LW-10060	(16bit) : IP0 of the HMI connecting to remote PLC 3 (IP address = IP0:IP1:IP2:IP3)	R/W	R/Y	R/Y
LW-10061	(16bit) : IP1 of the HMI connecting to remote PLC 3 (IP address = IP0:IP1:IP2:IP3)	R/W	R/Y	R/Y
LW-10062	(16bit) : IP2 of the HMI connecting to remote PLC 3 (IP address = IP0:IP1:IP2:IP3)	R/W	R/Y	R/Y
LW-10063	(16bit) : IP3 of the HMI connecting to remote PLC 3 (IP address = IP0:IP1:IP2:IP3)	R/W	R/Y	R/Y
LW-10064	(16bit) : port no. of the HMI connecting to remote PLC 3	R/W	R/Y	R/Y
LW-10065	(16bit) : IP0 of the HMI connecting to remote PLC 4 (IP address = IP0:IP1:IP2:IP3)	R/W	R/Y	R/Y
LW-10066	(16bit) : IP1 of the HMI connecting to remote	R/W	R/Y	R/Y

	PLC 4 (IP address = IP0:IP1:IP2:IP3)			
LW-10067	(16bit) : IP2 of the HMI connecting to remote PLC 4 (IP address = IP0:IP1:IP2:IP3)	R/W	R/Y	R/Y
LW-10068	(16bit) : IP3 of the HMI connecting to remote PLC 4 (IP address = IP0:IP1:IP2:IP3)	R/W	R/Y	R/Y
LW-10069	(16bit) : port no. of the HMI connecting to remote PLC 4	R/W	R/Y	R/Y
LW-10300	(16bit) : remote PLC 1's IP0 (IP address = IP0:IP1:IP2:IP3)	R/W	R/Y	R/Y
LW-10301	(16bit) : remote PLC 1's IP1 (IP address = IP0:IP1:IP2:IP3)	R/W	R/Y	R/Y
LW-10302	(16bit) : remote PLC 1's IP2 (IP address = IP0:IP1:IP2:IP3)	R/W	R/Y	R/Y
LW-10303	(16bit) : remote PLC 1's IP3 (IP address = IP0:IP1:IP2:IP3)	R/W	R/Y	R/Y
LW-10304	(16bit) : remote PLC 1's port no.	R/W	R/Y	R/Y
LW-10305	(16bit) : remote PLC 2's IP0 (IP address = IP0:IP1:IP2:IP3)	R/W	R/Y	R/Y
LW-10306	(16bit) : remote PLC 2's IP1 (IP address = IP0:IP1:IP2:IP3)	R/W	R/Y	R/Y
LW-10307	(16bit) : remote PLC 2's IP2 (IP address = IP0:IP1:IP2:IP3)	R/W	R/Y	R/Y
LW-10308	(16bit) : remote PLC 2's IP3 (IP address = IP0:IP1:IP2:IP3)	R/W	R/Y	R/Y
LW-10309	(16bit) : remote PLC 2's port no.	R/W	R/Y	R/Y
LW-10310	(16bit) : remote PLC 3's IP0 (IP address = IP0:IP1:IP2:IP3)	R/W	R/Y	R/Y
LW-10311	(16bit) : remote PLC 3's IP1 (IP address = IP0:IP1:IP2:IP3)	R/W	R/Y	R/Y
LW-10312	(16bit) : remote PLC 3's IP2 (IP address = IP0:IP1:IP2:IP3)	R/W	R/Y	R/Y
LW-10313	(16bit) : remote PLC 3's IP3 (IP address = IP0:IP1:IP2:IP3)	R/W	R/Y	R/Y
LW-10314	(16bit) : remote PLC 3's port no.	R/W	R/Y	R/Y
LW-10315	(16bit) : remote PLC 4's IP0 (IP address = IP0:IP1:IP2:IP3)	R/W	R/Y	R/Y
LW-10316	(16bit) : remote PLC 4's IP1 (IP address =	R/W	R/Y	R/Y

	IP0:IP1:IP2:IP3)			
LW-10317	(16bit) : remote PLC 4's IP2 (IP address = IP0:IP1:IP2:IP3)	R/W	R/Y	R/Y
LW-10318	(16bit) : remote PLC 4's IP3 (IP address = IP0:IP1:IP2:IP3)	R/W	R/Y	R/Y
LW-10319	(16bit) : remote PLC 4's port no.	R/W	R/Y	R/Y

22.21 Communication Error Messages & No. of Pending Cmd.

Address	Description	Read(R)/Write(W)/Control(Y)		
		Local HMI	MACRO R/Y	Remote HMI R/Y
LW-9350	(16bit) : pending command no. in local HMI	R	R	R
LW-9351	(16bit) : pending command no. in PLC 1 (COM 1)	R	R	R
LW-9352	(16bit) : pending command no. in PLC 2 (COM 2)	R	R	R
LW-9353	(16bit) : pending command no. in PLC 3 (COM 3)	R	R	R
LW-9354	(16bit) : pending command no. in PLC 4 (ethernet)	R	R	R
LW-9355	(16bit) : pending command no. in PLC 5 (ethernet)	R	R	R
LW-9356	(16bit) : pending command no. in PLC 6 (ethernet)	R	R	R
LW-9357	(16bit) : pending command no. in PLC 7 (ethernet)	R	R	R
LW-9390	(16bit) : pending command no. in PLC (USB)	R	R	R
LW-9400	(16bit) : error code for PLC 1	R	R	R
LW-9401	(16bit) : error code for PLC 2	R	R	R
LW-9402	(16bit) : error code for PLC 3	R	R	R
LW-9403	(16bit) : error code for PLC 4	R	R	R
LW-9404	(16bit) : error code for PLC 5	R	R	R
LW-9405	(16bit) : error code for PLC 6	R	R	R
LW-9406	(16bit) : error code for PLC 7	R	R	R
LW-9407	(16bit) : error code for PLC 8	R	R	R
LW-9490	(16bit) : error code for USB PLC	R	R	R

22.22 Miscellaneous Functions

Address	Description	Read(R)/Write(W)/Control(Y)		
		Local HMI	MACRO R/Y	Remote HMI R/Y
LB-9000 ~ LB-9009	initialized as ON	R/W	R/Y	R/Y
LB-9010	data download indicator	R	R	R
LB-9011	data upload indicator	R	R	R
LB-9012	data download/upload indicator	R	R	R
LB-9016	status is on when a client connects to this HMI	R	R	R
LB-9017	disable write-back in PLC control's [change window]	R/W	R/Y	R/Y
LB-9039	status of file backup activity (backup in process if ON)	R	R	R
LB-9045	memory-map communication fails (when ON)	R	R	R
LB-9049	enable (set ON)/disable (set OFF) watch dog (i series support only) *Note1	R/W	R/Y	R/Y
LB-9059	disable MACRO TRACE function (when ON) *Note2	R/W	R/Y	R/Y
LB-9064	enable USB barcode device (disable keyboard) (when ON) *Note3	R/W	R/Y	R
LW-9006	(16bit) : connected client no.	R	R	R
LW-9024	(16bit) : memory link system register	R/W	R/Y	R/Y
LW-9032	(8 words) : folder name of backup history files to SD, USB memory	R/W	R/Y	R/Y
LW-9050	(16bit) : current base window ID	R	R	R
LW-9134	(16bit) : language mode *Note4	R/W	R/Y	R/Y
LW-9300	(16bit) : driver ID of local PLC 1	R	R	R
LW-9301	(16bit) : driver ID of local PLC 2	R	R	R
LW-9302	(16bit) : driver ID of local PLC 3	R	R	R
LW-9303	(16bit) : driver ID of local PLC 4	R	R	R
LW-9530	(8 words) : VNC server password	R/W	R/Y	R/Y



1. When LB-9049 watch dog function is enabled, if there's a failure in communication for i Series HMI, system will reboot 10 seconds later.

2. LB-9059 Demonstration Project



3. LB-9064 Demonstration Project



4. When users would like to have the object's text to show multi-language, except for using Label Library, it needs to use the system reserved register [LW-9134: language mode]. The value of LW-9134 can be set from 0 to 7. Different data of LW-9134 corresponds to different Languages. The way of using LW-9134 will differ if the languages are not all chosen when compiling the downloaded file.

For example: If 5 languages are defined by user in Label Library as Language 1 (Traditional Chinese), Language 2 (Simplified Chinese), Language 3 (English), Language 4 (French), and Language 5 (Japanese). If only Language 1, 3, 5 are downloaded by user, the corresponding language of the value in LW-9134 will be 0 -> Language 1 (Traditional Chinese), 1 -> Language 3 (English), 2 -> Language 5 (Japanese).

Want to know how to swith languages using Option List object together with LW-9134?



Please confirm your Internet connection before downloading the demo project.

22.23 Remote Print/Backup Server

Address	Description	Read(R)/Write(W)/Control(Y)		
		Local HMI	MACRO R/Y	Remote HMI R/Y
LB-10069	forced to reconnect remote printer/backup server when IP changed on-line (set ON)	R/W	R/Y	R/Y
LW-9770	(16bit) : remote printer/backup server IP0 (IP0:IP1:IP2:IP3)	R/W	R/Y	R/Y
LW-9771	(16bit) : remote printer/backup server IP1 (IP0:IP1:IP2:IP3)	R/W	R/Y	R/Y
LW-9772	(16bit) : remote printer/backup server IP2 (IP0:IP1:IP2:IP3)	R/W	R/Y	R/Y
LW-9773	(16bit) : remote printer/backup server IP3 (IP0:IP1:IP2:IP3)	R/W	R/Y	R/Y
LW-9774	(6 words) : remote printer/backup server user name* Note1	R/W	R/Y	R/Y
LW-9780	(6 words) : remote printer/backup server password* Note1	R/W	R/Y	R/Y



1. When change settings using LW-9774 and LW9780, please reboot HMI to enable the new settings.

22.24 EasyAccess

Address	Description	Read(R)/Write(W)/Control(Y)		
		Local HMI	MACRO R/Y	Remote HMI R/Y
LB-9051	disconnect (set OFF)/connect (set ON) EasyAccess server	R/W	R/Y	R/Y
LB-9052	status of connecting to EasyAccess server	R	R	R
LB-9196	local HMI supports monitor function only (when ON)	R/W	R/Y	R/Y
LB-9197	support monitor function only for remote HMIs (when ON)	R/W	R/Y	R/Y

For further information on EasyAccess, please visit <http://www.ihmi.net/>.

22.25 Pass-Through Settings

Address	Description	Read(R)/Write(W)/Control(Y)		
		Local HMI	MACRO R/Y	Remote HMI R/Y
LW-9900	(16bit) : HMI run mode (0 : normal mode, 1~3 : test mode (COM 1~COM 3))	R/W	R/Y	R/Y
LW-9901	(16bit) : pass-through source COM port (1~3 : COM 1~COM 3)	R/W	R/Y	R/Y
LW-9902	(16bit) : pass-through destination COM port (1~3 : COM 1~COM 3)	R/W	R/Y	R/Y

22.26 Disable PLC No Response Dialog Box

Address	Description	Read(R)/Write(W)/Control(Y)		
		Local HMI	MACRO R/Y	Remote HMI R/Y
LB-9192	disable USB 1 PLC's "PLC No Response" dialog (when ON)	R/W	R/Y	R/Y
LB-9195	disable USB 2 PLC's "PLC No Response" dialog (when ON)	R/W	R/Y	R/Y
LB-11960	disable PLC 1's "PLC No Response" dialog (when ON)	R/W	R/Y	R/Y
LB-11961	disable PLC 2's "PLC No Response" dialog (when ON)	R/W	R/Y	R/Y
LB-11962	disable PLC 3's "PLC No Response" dialog (when ON)	R/W	R/Y	R/Y
LB-11963	disable PLC 4's "PLC No Response" dialog (when ON)	R/W	R/Y	R/Y
LB-11964	disable PLC 5's "PLC No Response" dialog (when ON)	R/W	R/Y	R/Y
LB-11965	disable PLC 6's "PLC No Response" dialog (when ON)	R/W	R/Y	R/Y
LB-11966	disable PLC 7's "PLC No Response" dialog (when ON)	R/W	R/Y	R/Y
LB-11967	disable PLC 8's "PLC No Response" dialog (when ON)	R/W	R/Y	R/Y

22.27 HMI and Project Key

Address	Description	Read(R)/Write(W)/Control(Y)		
		Local HMI	MACRO R/Y	Remote HMI R/Y
LB-9046	project key is different from HMI key (when ON)	R	R	R
LW-9046	(32bit) : HMI key (i series only) *Note1	R/W	R/Y	R



1. When change HMI key using LW-9046, please reboot HMI to enable the new settings.



Please confirm your Internet connection before downloading the demo project.

22.28 Fast Selection Window Control

Address	Description	Read(R)/Write(W)/Control(Y)		
		Local HMI	MACRO R/Y	Remote HMI R/Y
LB-9013	FS window control[hide(ON)/show(OFF)]	R/W	R/Y	R/Y
LB-9014	FS button control[hide(ON)/show(OFF)]	R/W	R/Y	R/Y
LB-9015	FS window/button control[hide(ON)/show(OFF)]	R/W	R/Y	R/Y

22.29 Input Object Function

Address	Description	Read(R)/Write(W)/Control(Y)		
		Local HMI	MACRO R/Y	Remote HMI R/Y
LW-9002	(32bit-float) : input high limit	R	R	R
LW-9004	(32bit-float) : input low limit	R	R	R
LW-9052	(32bit-float) : the previous input value of the numeric input object	R	R	R
LW-9150	(32 words) : keyboard's input data (ASCII)	R	R	R
LW-9540	(16bit) : reserved for caps lock	R	R	R

22.30 Local/Remote Operation Restrictions

Address	Description	Read(R)/Write(W)/Control(Y)		
		Local HMI	MACRO R/Y	Remote HMI R/Y
LB-9044	disable remote control (when ON)	R/W	R/Y	R/Y
LB-9053	prohibit password remote-read operation (when ON)	R/W	R/Y	R/Y
LB-9054	prohibit password remote-write operation (when ON)	R/W	R/Y	R/Y
LB-9196	local HMI supports monitor function only (when ON)	R/W	R/Y	R/Y
LB-9197	support monitor function only for remote HMIs (when ON)	R/W	R/Y	R/Y
LB-9198	disable local HMI to trigger a MACRO (when ON)	R/W	R/Y	R/Y
LB-9199	disable remote HMI to trigger a MACRO (when ON)	R/W	R/Y	R/Y

Chapter 23 HMI Supported Printers

23.1 The Supported Printer Types

HMI supported printer drivers include the following types:

EPSON ESC/P2 Series



EPSON compatible serial printers, please configure communication parameters to match the printer.

The EPSON ESC/P2 printer protocol is used.

Impact Printer:

LQ-300, LQ-300+, LQ-300K+ (RS232)

LQ-300+II (RS232)

Inkjet Printer:

Stylus Photo 750

Laser Printer:

EPL-5800

HP PCL Series (USB)



HP compatible USB printers that support HP PCL5 level 3 protocol.

- PCL 5 was released on HP LaserJet III in March 1990, added Intellifont font scaling (developed by Compugraphic, now part of Agfa), outline fonts and HP-GL/2 (vector) graphics.
- PCL 5e (PCL 5 enhanced) was released on HP LaserJet 4 in October 1992 and added bi-directional communication between printer and PC, and Windows fonts.

Please check if HP printer supports PCL5 before connecting with HMI, otherwise HMI black screen may occur.

SP-M, D, E, F



Serial printers, please configure communication parameters to match the printer. The **Pixels of Width** must be correctly set and can't exceed printer default setting:

100 pixels for 1610

220 pixels for 2407, 4004

EPSON ESC Protocol Serial Micro Printer:

SIUPO (Beijing)

<http://www.siuipo.com>

SP-M, D, E, F Series

SP-E1610SK (paper width 45mm), SP-E400-4S (paper width 57.5mm)

Recommended SP printer type for customers outside China.

Axiohm A630



Micro printer from France connects via serial port; please configure communication parameters to match the printer.

EPSON TM-L90



Serial printers, please configure communication parameters to match the printer. The **Pixels of Width** must be correctly set and can't exceed printer default setting "576":

SPRT



Serial printers, please configure communication parameters to match the printer. The **Pixels of Width** must be correctly set and can't exceed printer default setting "100":

SP-DN40SH Dot Matrix Printer

SP-RMDIII40SH Thermal

Remote Printer Server

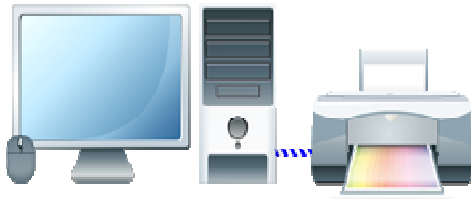

Use EasyPrinter to start printing for the printers connected with PC via Ethernet. This works under MS Windows so the most printers on market are supported.

BRIGHTTEK WH-C1/C2



Serial printers, please configure communication parameters to match the printer. The paper cutting mode can be selected: **[No cut]**, **[Half cut]**, and **[Full cut]**.

BRIGHTTEK WH-E19



Serial printers, please configure communication parameters to match the printer.

23.2 How to Add a New Printer and Start Printing

23.2.1 Add Printer Type

[System Parameter Settings] / [Model] select printer type and set relevant parameters.

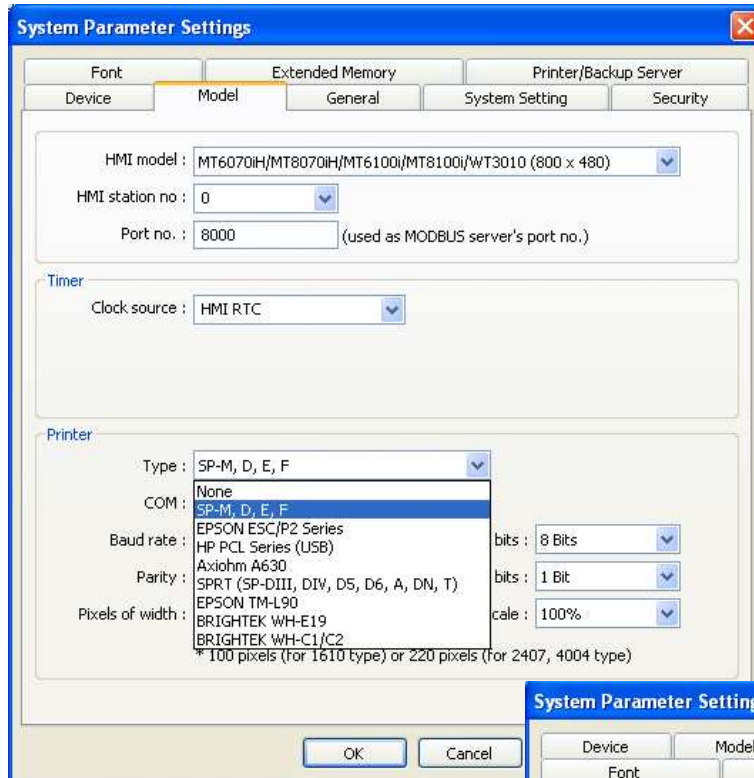

To connect Remote Printer Server, go [System Parameter Settings] /

[Printer/Backup Server], and set parameters correctly.

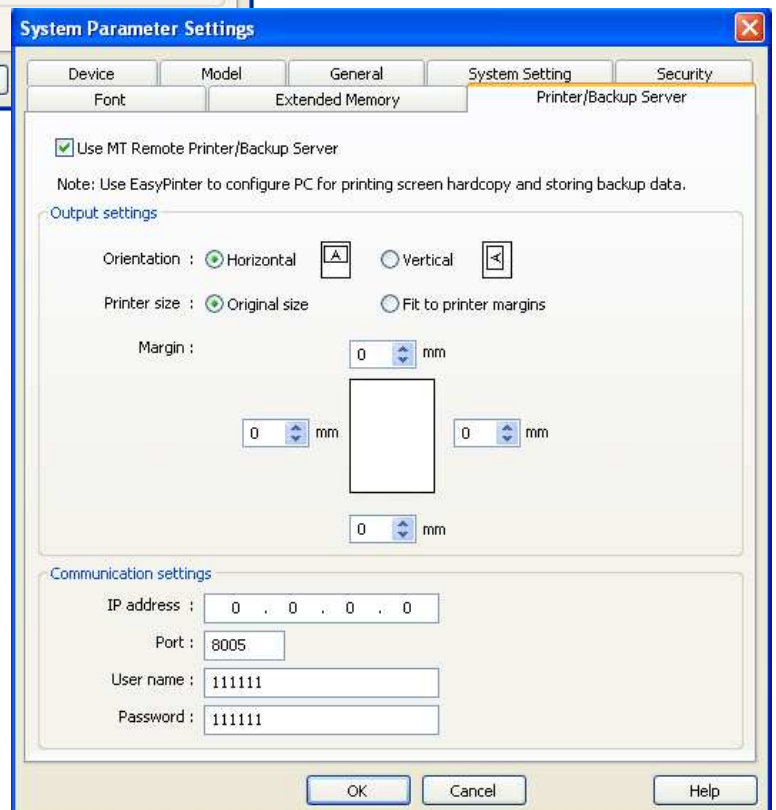

23.2.2 Start Printing

Start printing with  Function Key.



New Function Key Object

General Security Shape Label

Description :

Activate after button is released

Change full-screen window Change common window
 Display popup window

Return to previous window Close window

ASCII/UNICODE mode

[Enter] [Backspace] [Clear] [Esc]

[ASCII] / [UNICODE]

Execute macro

Window title bar

Hard copy screen to USB disk, SD card or printer

Screen hard copy Printer : SP-M, D, E, F
 Rotate image 90 degrees Mode : grayscale

Notification

Enable

OK Cancel

Or, use  PLC Control **[Screen hardcopy]** to start printing by predefined bit registers.

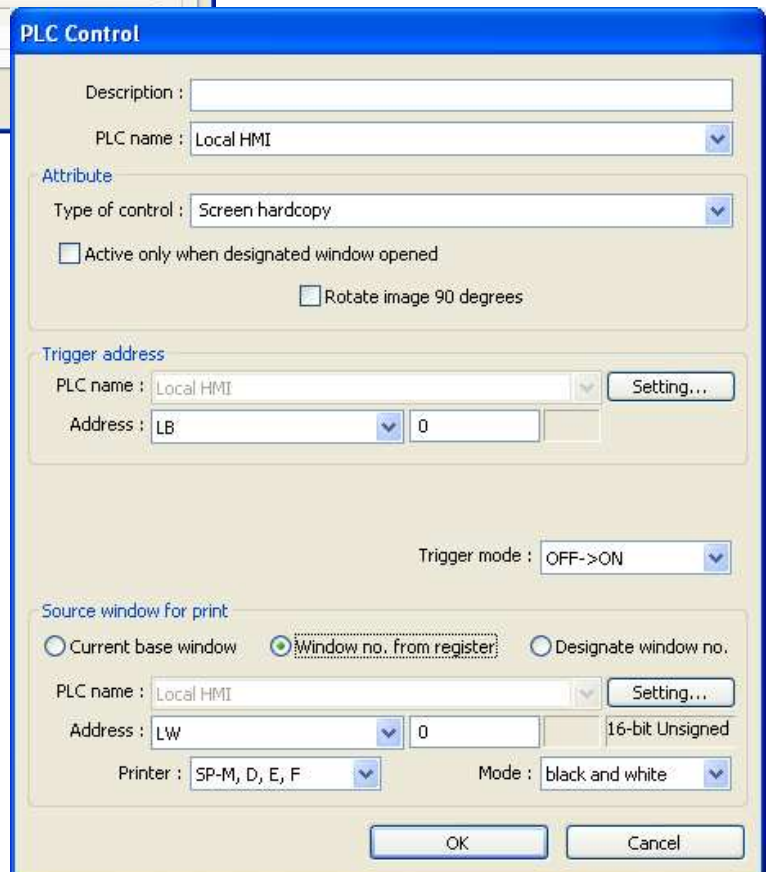

PLC Control

Description :

PLC name : Local HMI

Attribute

Type of control : Screen hardcopy

Active only when designated window opened
 Rotate image 90 degrees

Trigger address

PLC name : Local HMI Setting...

Address : LB 0

Trigger mode : OFF->ON

Source window for print

Current base window Window no. from register Designate window no.

PLC name : Local HMI Setting...

Address : LW 0 16-bit Unsigned

Printer : SP-M, D, E, F Mode : black and white

OK Cancel

Chapter 24 Recipe Editor

24.1 Introduction

Recipe Editor is used to create, view, and edit Recipe (*.rcp) and EMI (*.emi) files for HMI. Open Project Manager and click **[Recipe/Extended Memory Editor]**.



24.2 Recipe Editor Setting

How to add new *.rcp / *.emi files?

Set Address Range -> Select Data Format

[Select your data format]

Save the specified data format for next time loading. The saved file name: "dataEX.fmt" under EasyBuilder Pro installation directory.

[Address range]

Fill in address range, the unit is "word".

[Data format]

Edit new data format in this field.

Size	Type	Description
1 WORD	16-bit Unsigned	recipe no.
10 WORDs	String [ASCII]	product
2 WORDs	32-bit Unsigned	price
10 WORDs	String [ASCII]	barcode

Example 1

1. Click **[Add]**.

[Description]

Input the name of the data type.

[Data format] Select data format. If select **[String]**, please input the length (words) and ASCII/Unicode.

2. After setting, click **[OK]** to start editing recipe data.

Size	Type	Description
1 WORD	16-bit Unsigned	recipe no.
10 WORDs	String [ASCII]	product
2 WORDs	32-bit Unsigned	price
10 WORDs	String [ASCII]	barcode

ID	ADDRESS	recipe no.	product	price	barcode
0	0	0	bread	13	1547965231
1	23	1	coke	20	1437286591
2	46	2	coffee	245	3265479210
3	69	3	chair	599	6454789321
4	92	4	desk	750	1464545441
5	115	5	tea	15	1234534444
6	138	6	egg	8	4568974164
7	161	7	coke	28	1246634344
8	184	8	coke	29	4644245645
9	207	9	lemon	35	4645244575
10	230	10	tea bag	68	5676454567
11	253	11	book	245	4564676454
12	276	0		0	
13	299	0		0	
14	322	0		0	

3. In this example, the total length of data format is 23 words and will be seen as one set of recipe data.

The first set: "recipe no." = address 0, "product" = address 1 ~ 10, "price" = address 11 ~ 12, "barcode" = address 13 ~ 22;

The second set: "recipe no." = address 23, "product" = address 24 ~ 33, "price" = address 34 ~ 35, "barcode" = address 36 ~ 45...and so on.



■ After editing recipe data, it can be saved as *.rcp, *.emi, or *.csv. *.rcp can be downloaded to HMI using Project Manager or external devices (USB disk or SD card). *.emi can be saved directly to external device and insert to HMI for reading (EM register).

Chapter 25 EasyConverter

This application program is utilized when converting the history record of data sampling (DTL) or event log (EVT) stored in HMI to Excel.

25.1 How to Export to Excel

1. [EasyConverter] / [Open] / [OK]
2. Click [Export to Microsoft Excel]

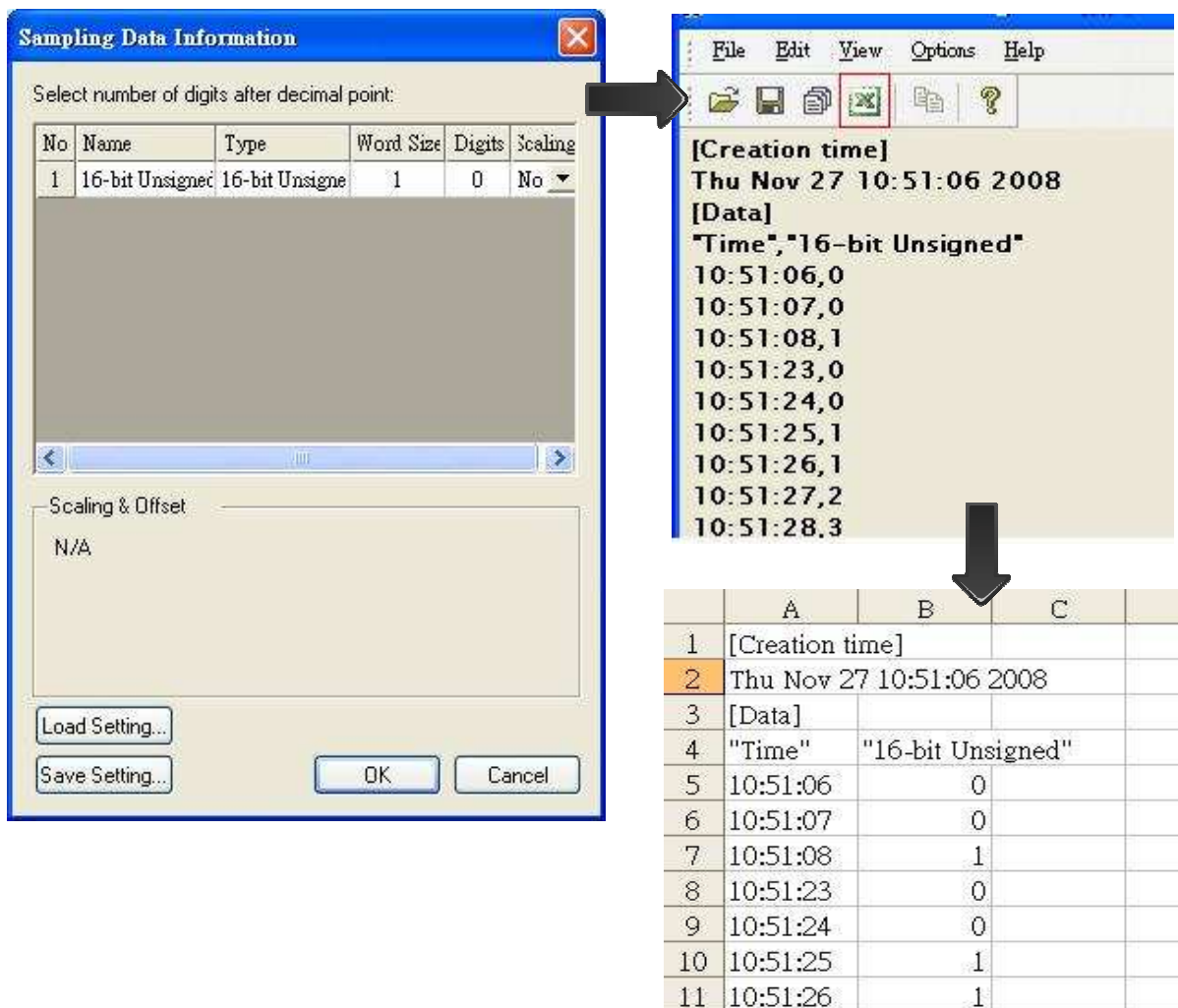

The image shows the 'Sampling Data Information' dialog box on the left and the EasyConverter main window on the right. The dialog box has a table with the following data:

No	Name	Type	Word Size	Digits	Scaling
1	16-bit Unsigned	16-bit Unsigne	1	0	No

The main window shows the menu bar (File, Edit, View, Options, Help) and a toolbar with icons for File, Save, Print, Export to Microsoft Excel (highlighted with a red box), Copy, and Help. The main display area shows the following text:

```
[Creation time]
Thu Nov 27 10:51:06 2008
[Data]
"Time", "16-bit Unsigned"
10:51:06,0
10:51:07,0
10:51:08,1
10:51:23,0
10:51:24,0
10:51:25,1
10:51:26,1
10:51:27,2
10:51:28,3
```

An arrow points from the 'Export to Microsoft Excel' icon in the toolbar to an Excel spreadsheet below. The spreadsheet has columns A, B, and C, and rows 1 through 11. The data in the spreadsheet is as follows:

	A	B	C
1	[Creation time]		
2	Thu Nov 27 10:51:06 2008		
3	[Data]		
4	"Time"	"16-bit Unsigned"	
5	10:51:06	0	
6	10:51:07	0	
7	10:51:08	1	
8	10:51:23	0	
9	10:51:24	0	
10	10:51:25	1	
11	10:51:26	1	

When converting event log into Excel, users can find an **[Event]** field in EasyConverter as below.

0 -> Event triggered; 1 -> Event acknowledged; 2 -> Event returns to normal

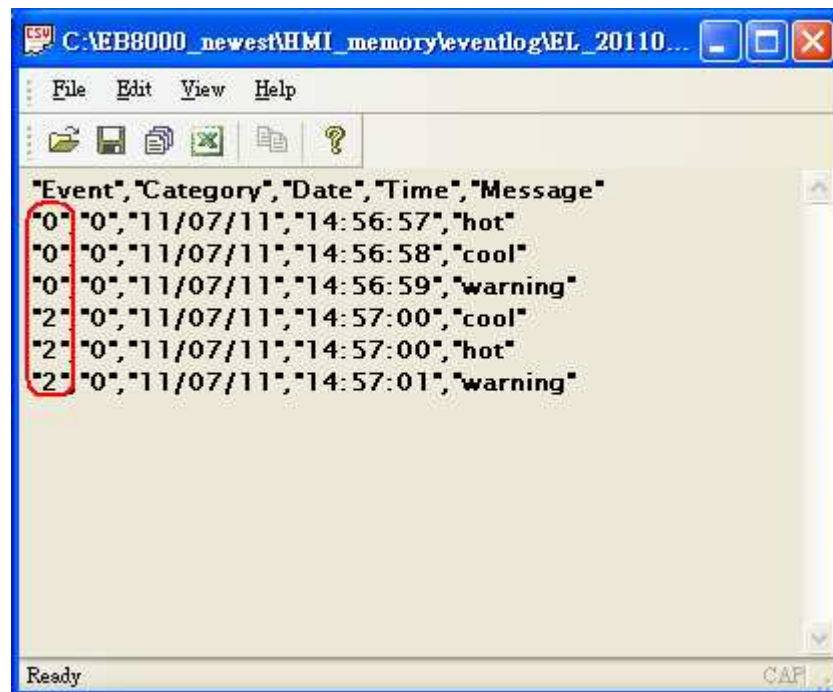

```
LSU C:\WEB8000_newest\HMI_memory\eventlog\EL_20110...
File Edit View Help
"Event","Category","Date","Time","Message"
"0" "0", "11/07/11", "14:56:57", "hot"
"0" "0", "11/07/11", "14:56:58", "cool"
"0" "0", "11/07/11", "14:56:59", "warning"
"2" "0", "11/07/11", "14:57:00", "cool"
"2" "0", "11/07/11", "14:57:00", "hot"
"2" "0", "11/07/11", "14:57:01", "warning"
Ready
```

25.2 How to Use Scaling Function

Scaling is utilized to offset data:

new value = [(value + A) x B] + C, users can set values of A, B, and C.

A: lower limit of the value ; C: engineering low

B: [(engineering high) - (engineering low) / (upper limit) - (lower limit)]



Example 1 For example, here is a voltage data with a format of 16-bit unsigned (range: 0 ~ 4096).

If users want to convert those data to volt range form -5V to +5V:

new value = [(value + 0) x 0.0024] + (-5):

Before:

After:

K:\1\20081203.dtl - EasyConvert

File Edit View Options Help

[Creation time]
Wed Dec 03 08:47:15 2008

[Data]
"Time", "16-bit Unsigned"

```
08:47:16,0.000
08:47:17,300.000
08:47:18,600.000
08:47:19,900.000
08:47:20,1200.000
08:47:21,1500.000
08:47:22,1800.000
08:47:23,2100.000
08:47:24,2400.000
08:47:25,2700.000
08:47:26,3000.000
08:47:27,3300.000
08:47:28,3600.000
08:47:29,3900.000
08:47:30,4096.000
08:47:31,3796.000
08:47:32,3496.000
08:47:33,3196.000
08:47:34,2896.000
08:47:35,2596.000
08:47:36,2296.000
```

K:\1\20081203.dtl - EasyConve

File Edit View Options Help

[Creation time]
Wed Dec 03 08:47:15 2008

[Data]
"Time", "16-bit Unsigned"

```
08:47:16,-5.000
08:47:17,-4.268
08:47:18,-3.536
08:47:19,-2.804
08:47:20,-2.072
08:47:21,-1.340
08:47:22,-0.608
08:47:23,0.124
08:47:24,0.856
08:47:25,1.588
08:47:26,2.320
08:47:27,3.052
08:47:28,3.784
08:47:29,4.516
08:47:30,4.994
08:47:31,4.262
08:47:32,3.530
08:47:33,2.798
08:47:34,2.066
08:47:35,1.334
08:47:36,0.602
```

Sampling Data Information 

Select number of digits after decimal point:

No	Name	Type	Word Size	Digits	Scaling
1	16-bit Unsigned	16-bit Unsi	1	3	Yes 

Scaling & Offset

A	B	C
0.0000	0.0024	-5.0000

new value = ((value + A) x B) +
= (value x 0.0024) + -5.0000



Settings of data above can be saved as a sample and loaded next time. The file name of the sample: *.LGS.

- After setting the values for Scaling, click **[Save Setting]**
- In a new sample, click **[Load Setting]** to use the sample saved before.

25.3 How to Use Multi-File Conversion

Example 1

1. Click **[File] / [Multi-File] / [Add File]** to combine multiple added files into one Excel file.
2. Click **[Combine to a file]**, files will be separated into sheets of one EXCEL (*.XLS) file labeled with the dated it is created. If users don't check this box, the files will be exported to Excel individually.

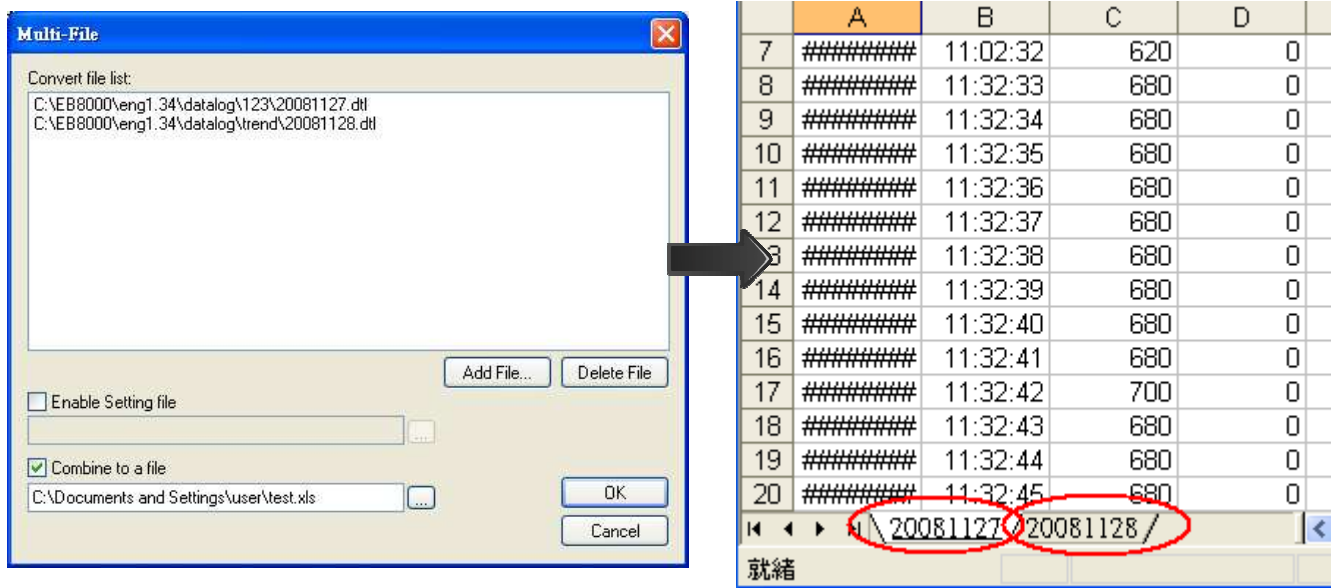

The saved setting files can be loaded for combining:

Check both **[Enable Setting file]** and **[Combine to a file]** boxes and select the files to be combined then click **[OK]**.

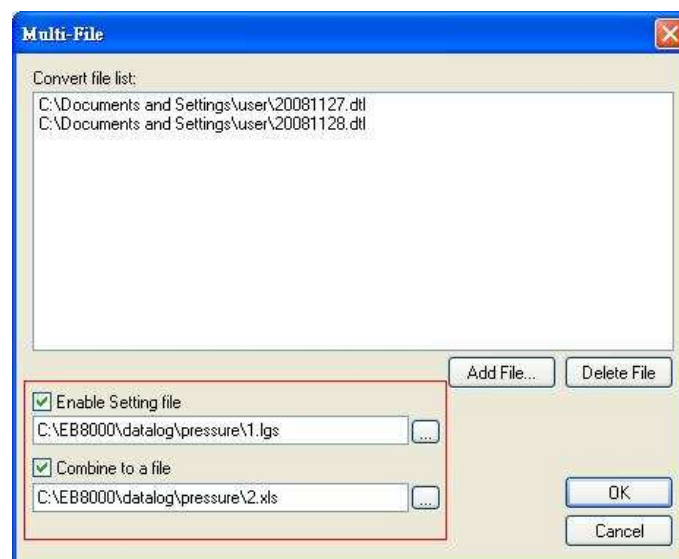

Chapter 26 EasyPrinter

EasyPrinter is a Win32 application and can only run on MS Windows 2000 / XP / Vista / 7. It enables MT8000 Series to output screen hardcopies to a remote PC via Ethernet. Please see the following illustration:

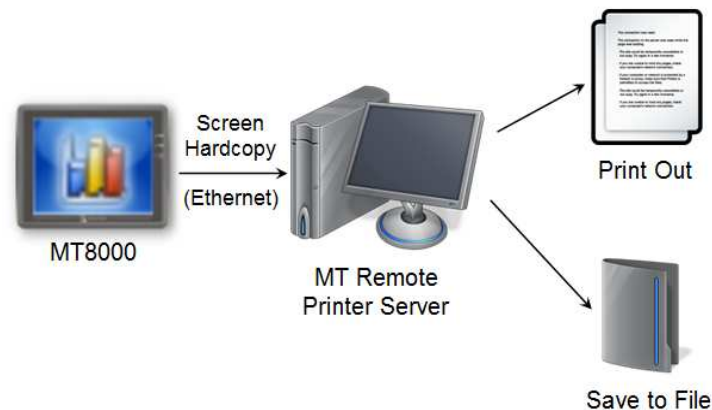

Here are some advantages of using EasyPrinter:

EasyPrinter provides two modes of hardcopy output: Print-Out and Save-to-File. Users can use either way or both ways.

Since EasyPrinter is running on MS Windows system, it supports most of the printers available in the market.

Multiple MT8000 HMI can share one printer via EasyPrinter. Users don't have to prepare printers for each MT8000 HMI.

Additionally, EasyPrinter can also be a backup server. Users can use backup objects in MT8000 HMI to copy history files such as Data-Sampling and Event-Log histories onto a remote PC via Ethernet. Please see the following illustration:

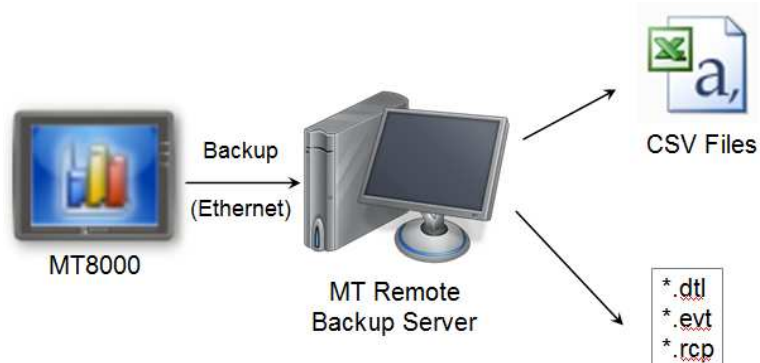

26.1 Using EasyPrinter as a Printer Server

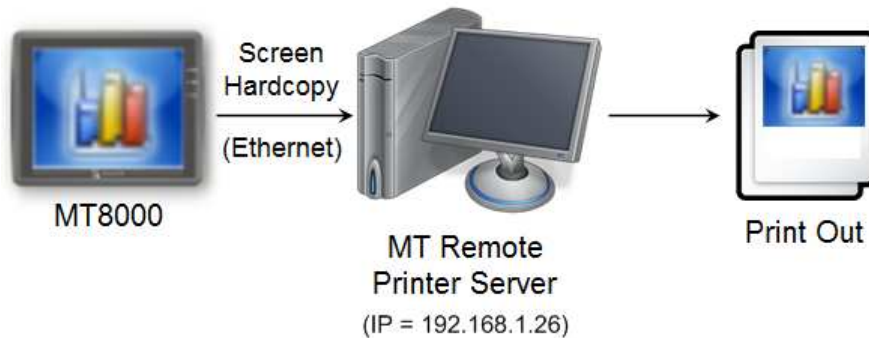

Users can make screen hardcopies with a **[Function Key]** object. The hardcopies will be transferred to the MT Remote Printer Server via Ethernet and then printed out.

26.1.1 Setup Procedure in EasyPrinter

In **[Menu]** → **[Options]**, select **[Settings...]** and the following dialogue appears:

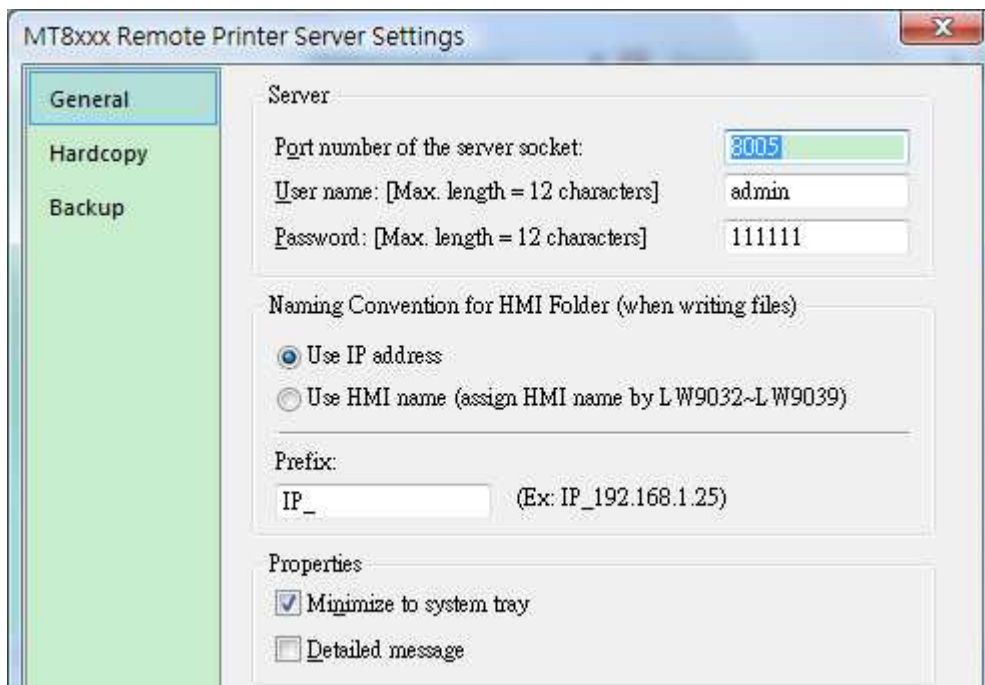

1. In **[Server]**, assign **[Port number of the server socket]** to "8005", **[User name]** to "admin" and **[Password]** to "111111". (Note: These

are default values.)

2. In **[Naming Convention for HMI Folder]**, select **[Use IP address]** and assign "IP_" as the **[Prefix]**.
3. In **[Properties]**, select **[Minimize to system tray]**.

Click **[Hardcopy]** tab on the left side in the dialogue box as follows:

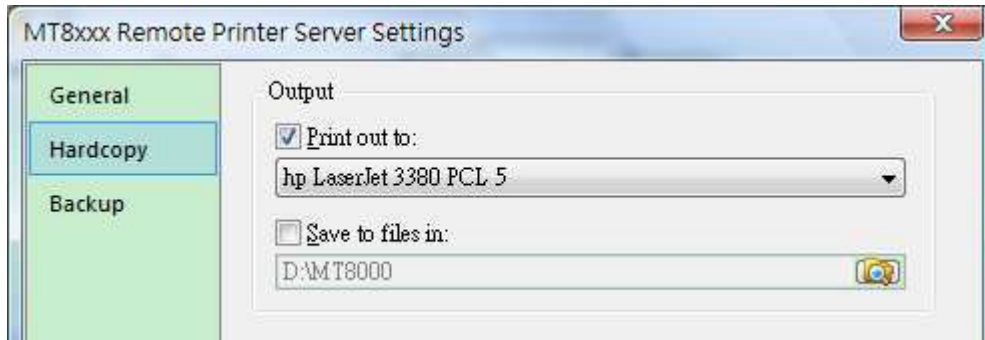

4. In **[Output]**, select **[Print out to]** and choose a printer as the output device for screen hardcopies. (Note: Users can only choose from the printers available in their system, so it is possible that "hp LaserJet 3380 PCL 5" can't be found in the list as the example.)
5. Click **[OK]** to apply the settings.
6. In **[Menu] → [File]**, select **[Enable Output]** to allow EasyPrinter to output any incoming print request, i.e. screen hardcopy.

26.1.2 Setup Procedure in EasyBuilder8000

In **[Menu] → [Edit] → [System Parameters]**, click **[Printer Server]** tab and select **[Use MT Remote Printer Server]**, the following dialogue appears:

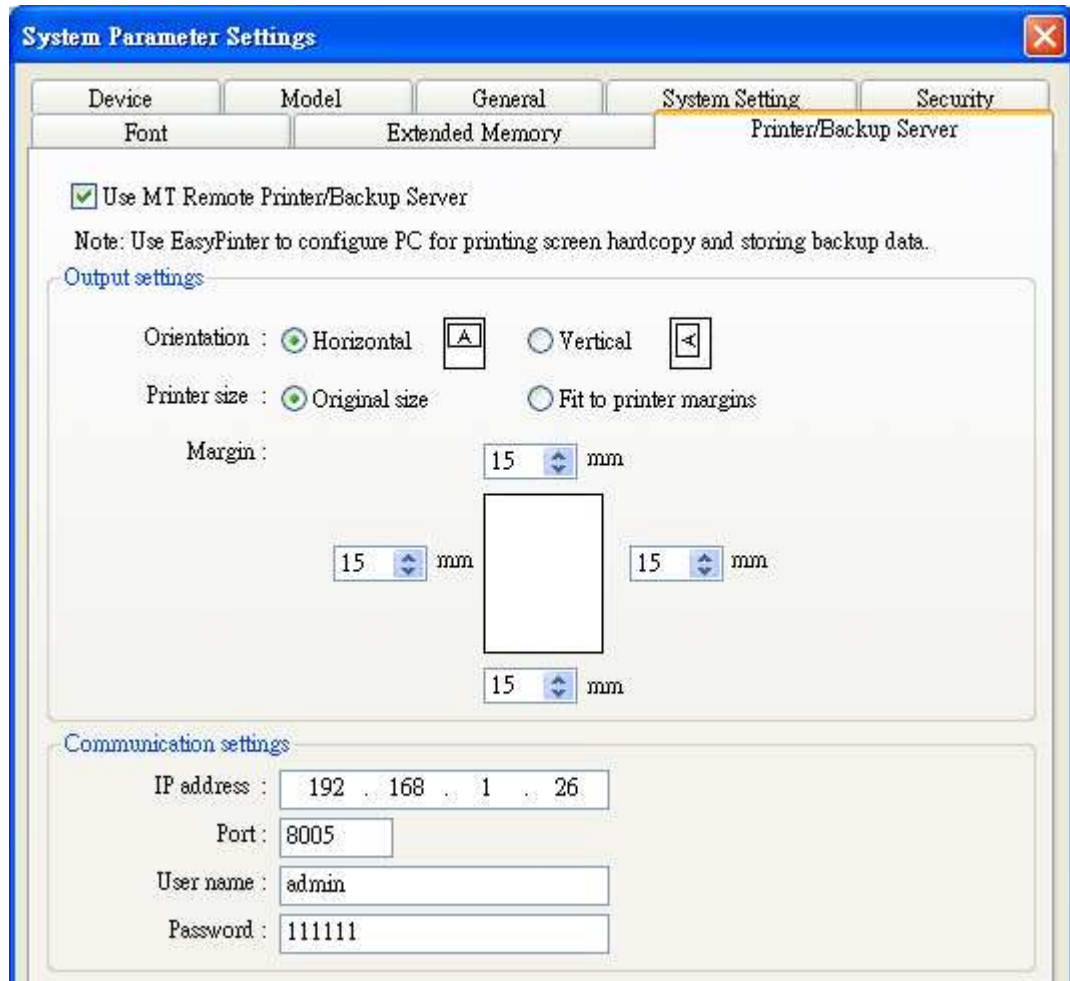

7. In **[Output settings]**, assign appropriate values for left/top/right/bottom margins. (Note: The margins are all assigned to 15mm in the example.)
8. In **[Communication settings]**, fill in the **[IP address]** of the printer server same as step 1, assign the **[port number]** to “8005”, **[User name]** to “admin” and **[Password]** to “111111”.

In **[Menu] → [Objects] → [Buttons]**, select **[Function Key]** and assign **[Screen hardcopy]** to **[MT Remote Printer Server]**.

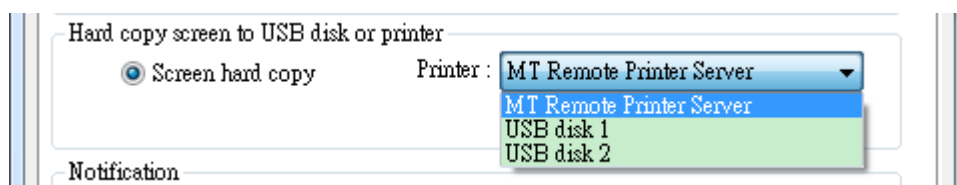

9. Place the **[Function Key]** object in the common window (window no.

4), and users will be able to make screen hardcopies anytime when needed.

10. **[Compile]** and **[download]** project to MT8000 HMI. Press the **[Function Key]** object set in step 9 to make a screen hardcopy.

NOTE

5. Users can also use a **[PLC Control]** object to make screen hardcopies.
6. Users cannot print alarm information via EasyPrinter.
7. EasyPrinter can only communicate with HMI via Ethernet, so this feature is unavailable in MT6000 Series.

26.2 Using EasyPrinter as a Backup Server

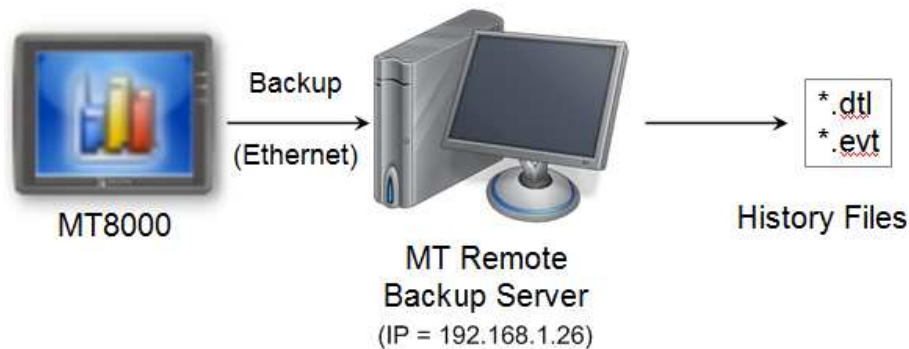

Users can upload historical data such as Data-Sampling and Event-Log history files onto MT remote backup server with **[Backup]** objects.

26.2.1 Setup Procedure in EasyPrinter

In **[Menu]** → **[Options]**, select **[Settings...]** and the following dialogue appears:

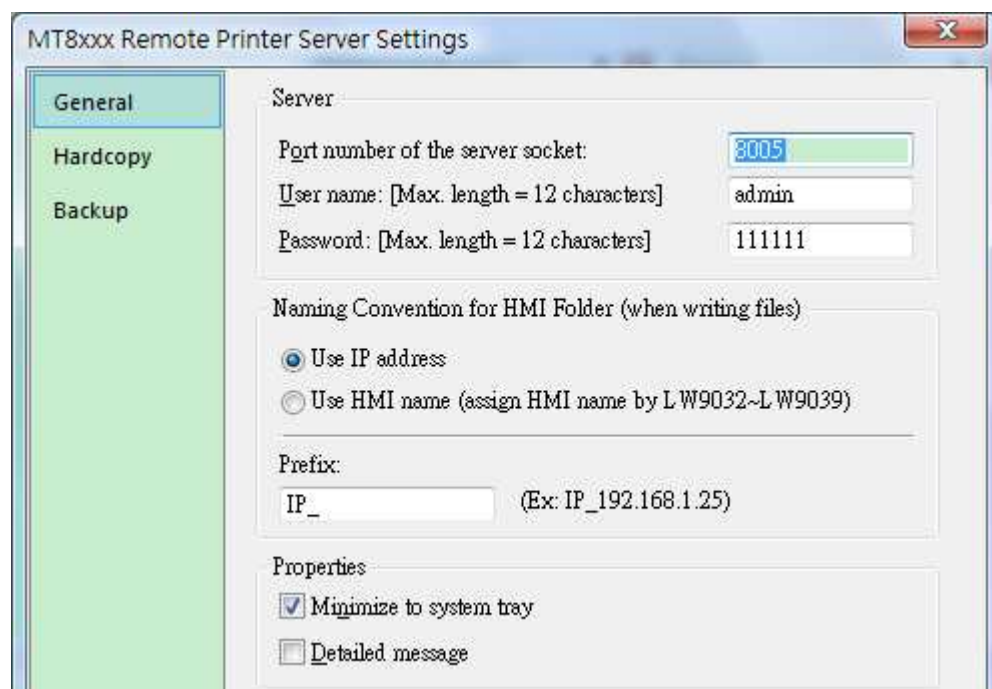



1. In **[Server]**, assign **[Port number of the server socket]** to “8005”, **[User name]** to “admin” and **[Password]** to “111111”. (Note: These are default values.)
2. In **[Naming Convention for HMI Folder]**, select **[Use IP address]** and

assign "IP_" as the **[Prefix]**.

3. In **[Properties]**, select **[Minimize to system tray]**.

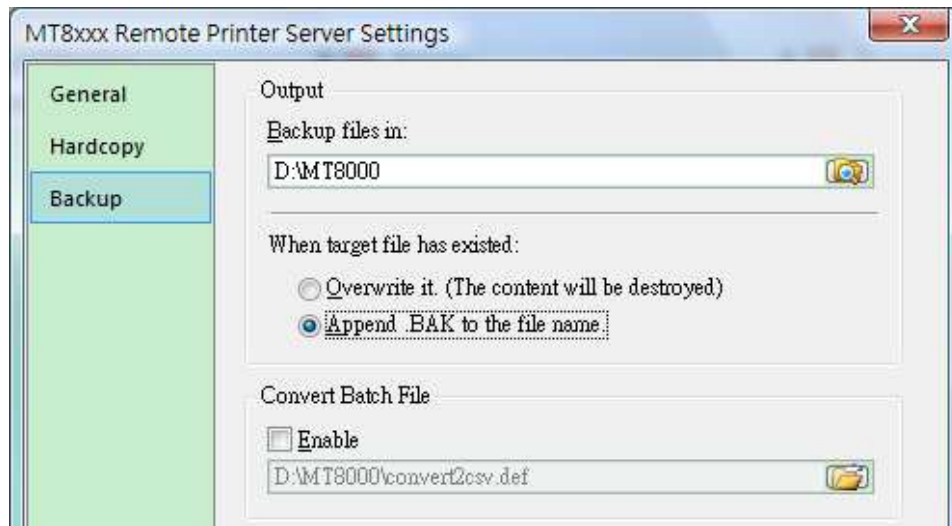
Click **[Backup]** tab on the left side in the dialogue box as follows:



4. In **[Output]**, click the  button to browse and select a path for storage of the incoming history files.
5. Click **[OK]** to apply the settings.
6. In **[Menu] → [File]**, select **[Enable Output]** to allow EasyPrinter to store any incoming backup request in the location specified in step 4.

26.2.2 Setup Procedure in EasyBuilder8000

In **[Menu] → [Edit] → [System Parameters]**, click **[Printer Server]** tab and select **[Use MT Remote Printer Server]**, the following dialogue appears:

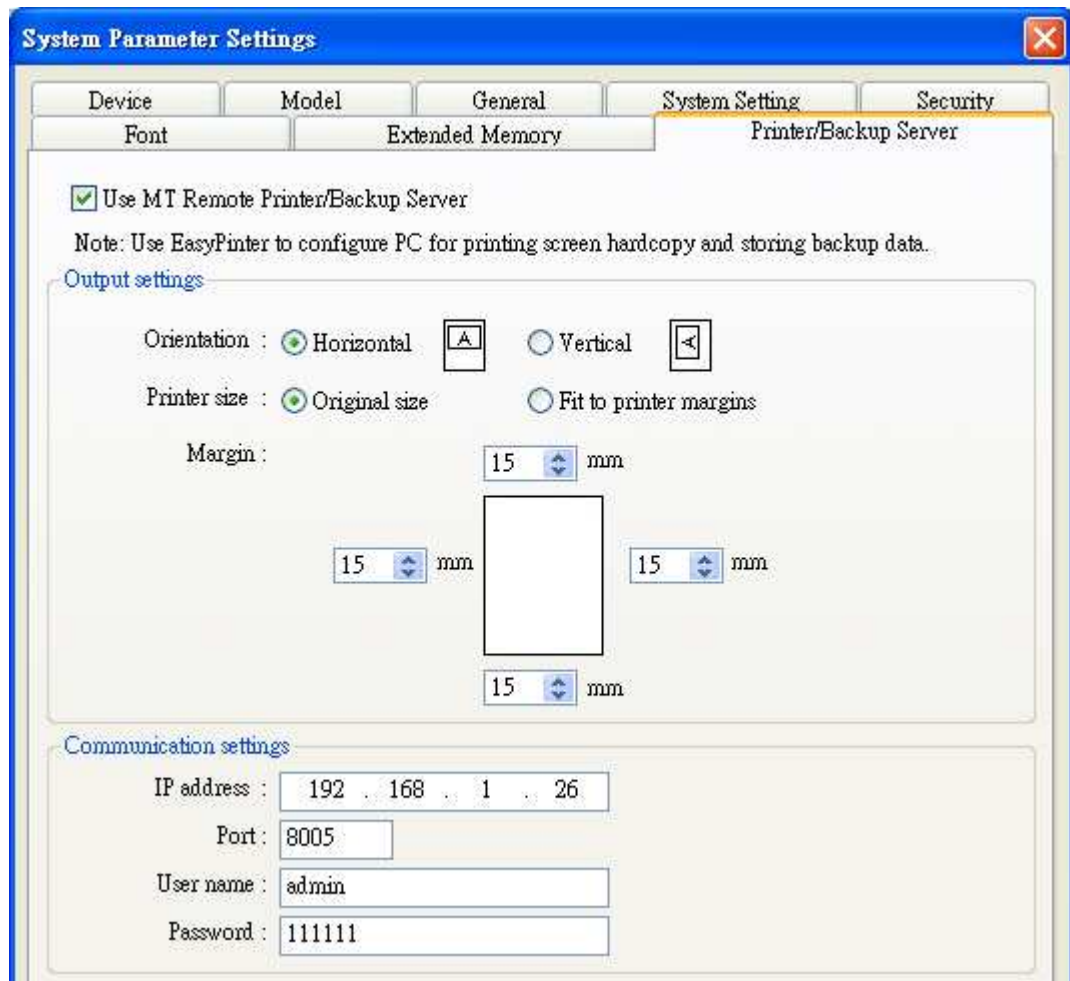

7. In **[Communication settings]**, fill in the **[IP address]** of printer server same as step 1, assign **[port number]** to "8005", **[User name]** to "admin" and **[Password]** to "111111".

In **[Menu]** → **[Objects]**, select **[Backup]** and the following dialogue appears:

New Backup Object

General Security Shape Label

Description :

Source

RW RW_A Historical event log Historical data log

Backup position

USB 1 USB 2 Remote printer/backup server

Note : Use LW9032~9039 to change the backup folder name.

Note : Use [Remote printer/backup server] to store data to a remote PC. Enable the server in [System Parameter][Printer/Backup Server] settings.

Range

Start : Today Yesterday

Within : All

Attribute

Mode : Touch trigger

8. In [Source], select **[Historical event log]**.
9. In [Backup position], select **[Remote printer server]**.
10. In [Range], select **[Today]** and **[All]**.
11. In [Attribute], select **[Touch trigger]**.
12. Place the **[Backup]** object in the common window (window no. 4), and users will be able to make backups anytime when needed.
13. **[Compile]** and **[download]** project to MT8000 HMI. Press the **[Backup]** object set in step 12 to make a backup of the Event-Log history data.

NOTE

8. The **[Backup]** object can be triggered via a bit signal.
9. Users can arrange a **[Scheduler]** object, which turns a bit ON at the end of week, to trigger a **[Backup]** object to automatically back up all history data.

26.3 EasyPrinter Operation Guide

26.3.1 Appearance

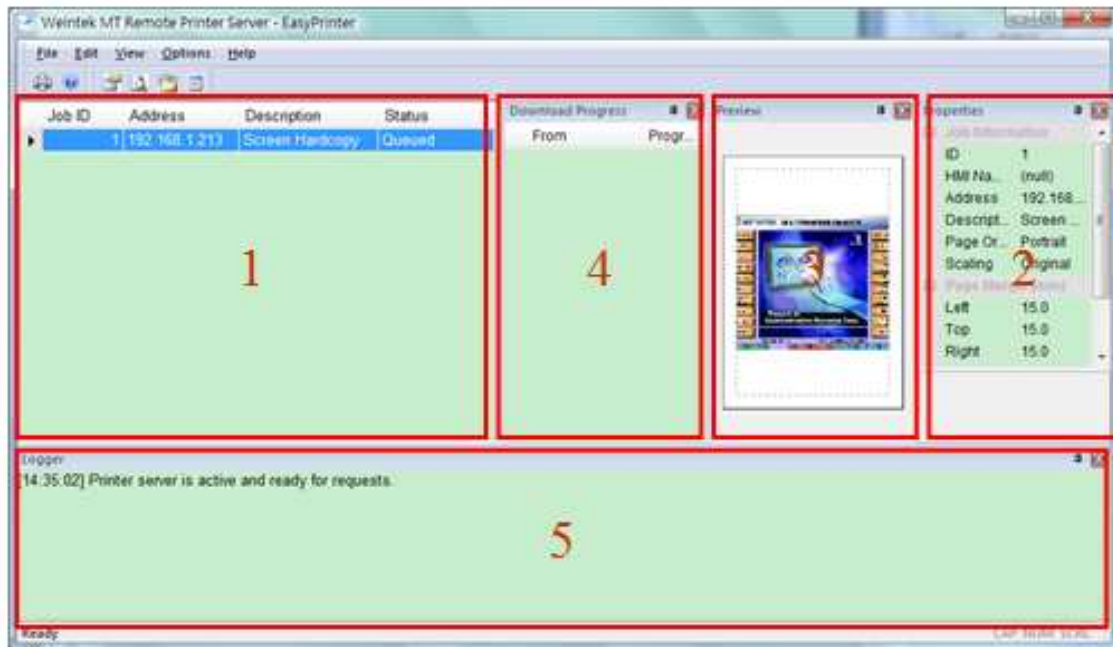

Area	Name	Description
1	Job List	This window lists all incoming tasks, i.e. screen hardcopy and backup requests.
2	Property Window	This window shows the information about the task selected from "Job List."
3	Preview Window	This window shows the preview image of the screen hardcopy task selected from "Job List."
4	Download Progress Window	This window shows the download progress of incoming requests.
5	Message Window	This window shows the time and message of events such as incoming request, incorrect password, etc.

26.3.2 Operation Guide

The following tables describe the meaning and explain how to use all EasyPrinter menu items.

Menu → File	Description
Enable Output	<ul style="list-style-type: none"> • Selected EasyPrinter processes the tasks one by one. • Unselected EasyPrinter arranges the incoming tasks in memory.

NOTE

10. EasyPrinter can only reserve up to 128 MB of task data in memory. If the memory is full, any request coming in afterwards will be rejected and users must either operate **[Enable Output]** or delete some tasks to make room for new tasks.

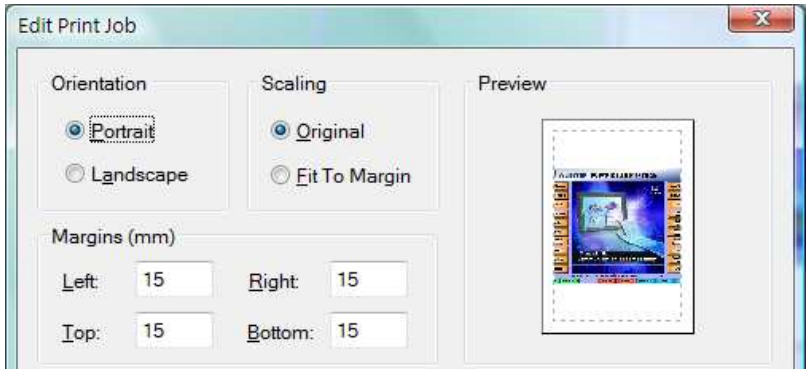
Menu → Edit	Description
Edit	<p>To edit a screen hardcopy task.</p>  <p>Users can freely change the properties of [Orientation], [Scaling] and [Margins] here.</p>
Delete	To delete the selected tasks permanently.
Select All	To select all tasks from “Job List.”

NOTE

- The backup task is not editable.
- [Edit]** is available only when a task is selected.
- [Delete]** is available when at least one task is selected.

Menu → View	Description
Properties Bar	To show or hide the Property Window.
Preview Bar	To show or hide the Preview Window.
Download Bar	To show or hide the Download Progress Window.
Logger Bar	To show or hide the Message Window.

NOTE

14. In **[Download Progress]** Window, users can select the mode to show download progress by clicking the header of the **[progress]** column. Please see the following illustration:

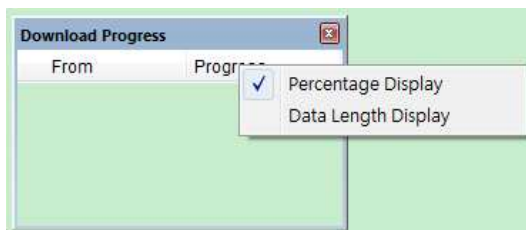

15. EasyPrinter can reserve up to 10,000 messages in Message Window. If a new message comes in, the oldest message will be deleted.

Menu→Options	Description
Toolbars	To show or hide toolbars.
Status Bar	To show or hide the status bar.
Settings	Configuration for EasyPrinter. Please refer to the following illustrations: <div style="background-color: #ADD8E6; padding: 2px;">[General]</div>

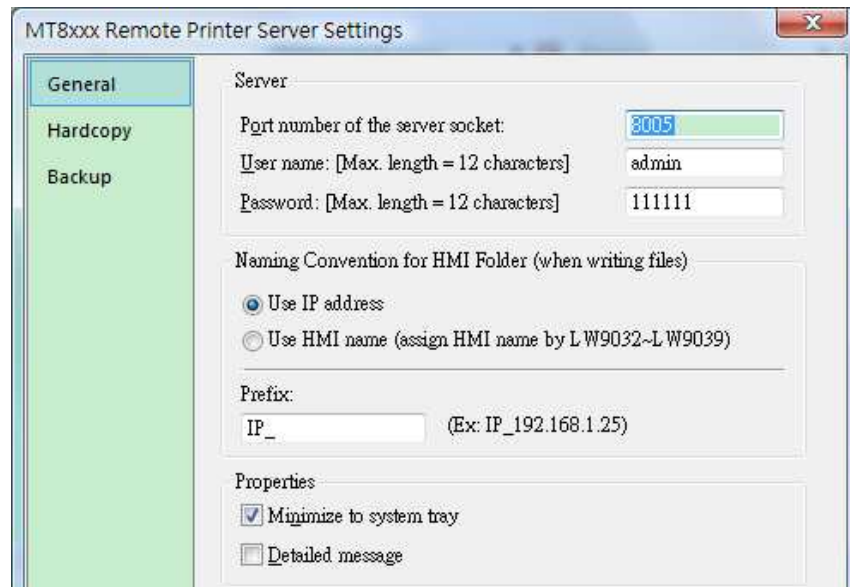

- **[Server] → [Port number of the server socket]**
Set the Ethernet socket number for HMI to connect to. The range goes from 1 to 65535 and 8005 is the default value.
- **[Server] → [User name] & [Password]**
Set the user name and password to restrict that only authorized HMI can send requests to EasyPrinter.
- **[Naming Convention for HMI Folder]**
EasyPrinter creates different folders to store files (e.g. hardcopy bitmap files, backup files) from different HMI. There are two ways to name the folders:
 - a. Use IP address**
EasyPrinter names the folder after the IP address of the HMI sending the request. (i.e. [Prefix] + [IP address])
Please see the following illustration:

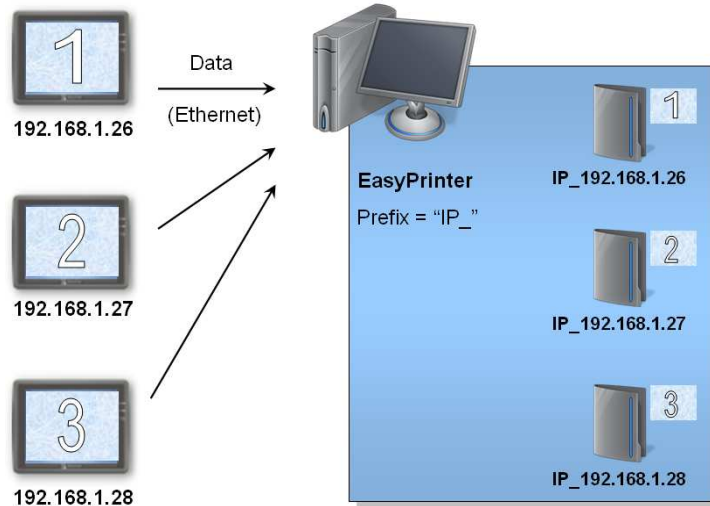

b. Use HMI name

EasyPrinter names the folder after the name of the HMI sending the request. (i.e. [Prefix] + [HMI name])

- **[Properties] → [Minimize to system tray]**

Select this option to minimize EasyPrinter to system tray instead of task bar. Users can double-click the icon in system tray to restore the EasyPrinter window.

- **[Properties] → [Detailed message]**

Select this option to display more detailed messages about events in the message window.

[Hardcopy]

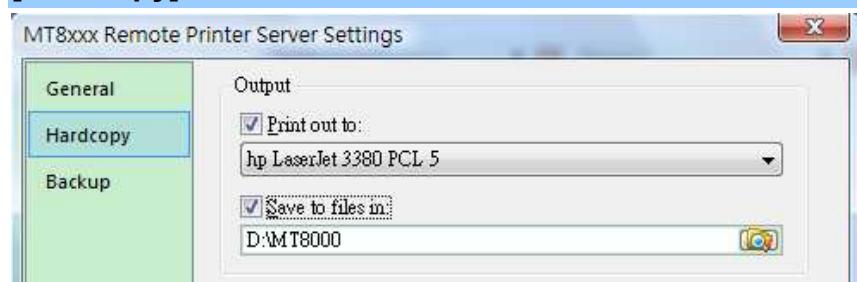

- **[Output]**

EasyPrinter provides two modes to output hardcopy results: Print-Out and Save-to-File.

a. Print-Out

Select this option to inform EasyPrinter to print out the hardcopy result with specified printers.

b. Save-to-File

Select this option to inform EasyPrinter to convert the hardcopy result into a bitmap file and save it in the specified directory. Users can find the bitmap files at:

[Specified Path] →
 [HMI Folder] →
 yymmdd_hhmm.bmp

For example, when a hardcopy request is given at 17:35:00 12/Jan/2009, the bitmap file will be named "090112_1735.bmp". And if there is another bitmap file generated in the same minute, it will be named "090112_1735_01.bmp" and so on.

[Backup]

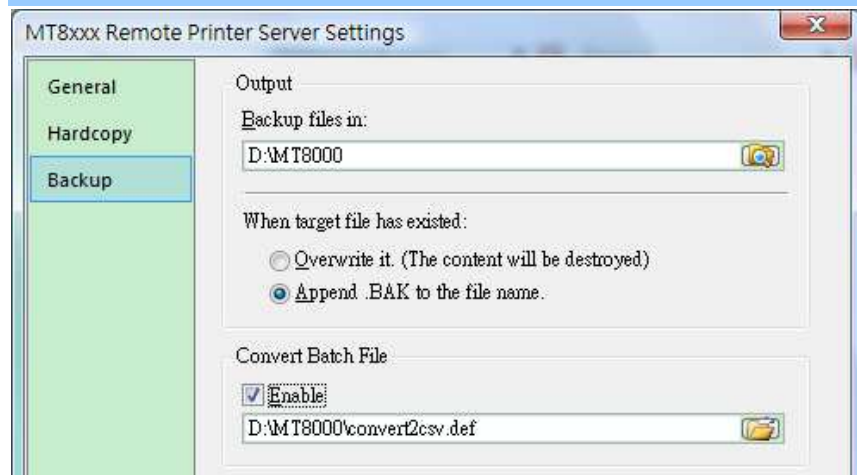

- **[Output]**

EasyPrinter stores the backup files to the specified path.

For Event-Log historical data files:

[Specified Path] →
 [HMI Folder] →
 [eventlog] →
 EL_yyyymmdd.evt

For Data-Sampling historical data file:

[Specified Path] →
 [HMI Folder] →

	<p>[datalog] → [Folder name of the Data-Sampling object]→ yyyymmdd.dtl</p> <p>For Recipe: [Specified Path] → [HMI Folder] → [recipe] → recipe.rcp or recipe_a.rcp</p> <ul style="list-style-type: none">● [Convert Batch File] Select [Enable] and assign a Convert Batch File for automatically converting uploaded history files to CSV or MS Excel format. Please refer to the next section for the details of Convert Batch File.
--	---

NOTE

16. Users can assign HMI names from LW9032 to LW9039.
17. EasyPrinter names the folder after IP address if HMI name is not set.

26.4 Convert Batch File

EasyPrinter provides a mechanism for converting the uploaded Data-Sampling and Event-Log history files stored in binary mode to CSV files automatically. Users requesting this function have to prepare a Convert Batch File to provide EasyPrinter with the information of how to convert the history files.

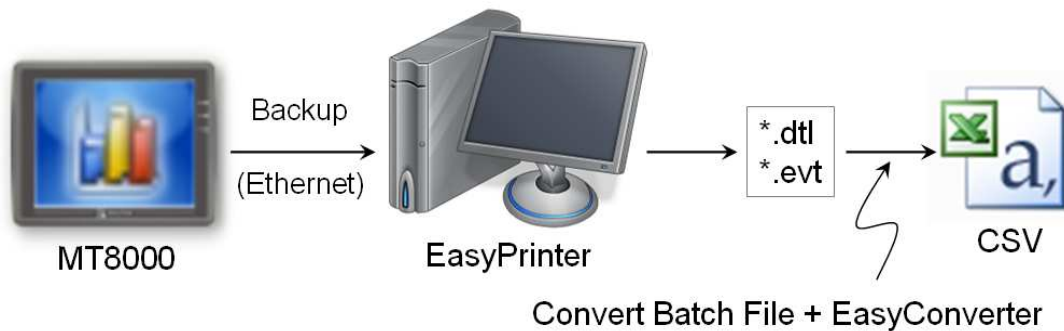

As shown in the illustration above, the conversion is actually carried out by EasyConverter. EasyPrinter simply follows the criteria in Convert Batch File and activates EasyConverter with proper arguments to achieve the conversion.

NOTE

18. EasyConverter is another Win32 application converting history data into CSV or MS Excel (*.xls) files. Users can find it in the EasyBuilder 8000 installation directory.
19. Users requesting this function must ensure EasyPrinter and EasyConverter are placed in the same directory.

26.4.1 The Default Convert Batch File

The following is the default Convert Batch File included in the EasyBuilder 8000 software package:

The default Convert Batch File (convert2csv.def)

- 1: "dtl", "EasyConverter /c \$(PathName)"
- 2: "evt", "EasyConverter /c \$(PathName)"

There are two lines of text in the file. Each line has two arguments separated by a comma and forms a criterion of how to deal with a specific type of files, e.g.

Data-Sampling and Event-Log history files. The first argument specifies the extension name for the type of the files to be processed and the second one specifies the exact command to execute in console mode. Please note “\$(PathName)” is a key word to tell EasyPrinter to replace it with the real name of the backup file in conversion. For example, if a Data-Sampling history file named 20090112.dtl is uploaded and stored, EasyPrinter will send out the following command to a console window:

```
EasyConverter /c 20090112.dtl
```

And then the CSV file named 20090112.csv is created.

Therefore, the criteria of the default Convert Batch File are:

1. Convert all Data-Sampling history files (*.dtl) into CSV files.
2. Convert all Event-Log history files (*.evt) into CSV files.

NOTE

20. Actually, the “\$(PathName)” in the second argument stands for the full path name of the file. In the previous case, EasyPrinter replaces it with:

```
[Specified Path] \ [HMI Folder] \ [datalog] \  
[Folder name of the Data-Sampling object] \ 20090112.dtl
```
21. EasyPrinter interprets the Convert Batch File on a line basis, i.e. each line forms a criterion.
22. Any two arguments should be separated by a comma.
23. Every argument should be put in double quotes.
24. Do not put any comma inside an argument.
25. For further information about how to use EasyConverter, please refer to the “chapter25 Easy Converter”.

26.4.2 Specialized Criteria

Sometimes users may need a special handling for the files uploaded from a specific HMI. Here is an example:

```
Specialized Criterion for the HMI with IP = 192.168.1.26
```

```
3: "dtl", "EasyConverter /c $(PathName)", "192.168.1.26"
```

Or users can also specify the HMI with its name.

Specialized Criterion for the HMI with name = Weintek_01

4: "dtl", "EasyConverter /c \$(PathName)", "Weintek_01"

Or in the case of needing special handling for different Data-Sampling history files.

Specialized Criterion for the Data-Sampling object's folder name = Voltage

5: "dtl", "EasyConverter /s Voltage.lgs \$(PathName)", "*", "Voltage"

The 5th criterion can only be performed on the history files uploaded from the **[Data Sampling]** objects with the folder name "Voltage". The 3rd argument ("*") indicates this criterion accepts the qualified Data-Sampling files from any HMI. Users can also change the 3rd argument to "192.168.1.26", "192.168.1.*", HMI name, etc. for narrowing the target HMI.

26.4.3 The Format of a Convert Batch File

The following table explains all arguments in a criterion.

No	Argument	Description
1	File Type	This argument specifies the extension name of the uploaded files this criterion targets. (e.g. "dtl" for Data-Sampling history files, "evt" for Event-Log history files)
2	Command Line	The exact command EasyPrinter sends to a console window if the uploaded file is qualified.
3	a. HMI IP address b. HMI name	This argument specifies the HMI this criterion targets.
4	Condition 1	<ul style="list-style-type: none"> If the file type is "dtl" This argument specifies the folder name of the [Data Sampling] objects this criterion targets. Others No use.
5	Condition 2	No use. (reserved for further use)

26.4.4 The Order of Examining Criteria

EasyPrinter examines criteria in ascending order every time a file is uploaded. Once the file is qualified for a criterion, it stops the examination and starts over for next file. Therefore, users should place the criteria with more specification upward in the Convert Batch File and place the less-specific criteria downward. Take the 5 criteria mentioned in the previous sections for example, the correct order is:

Correct order for the previous criteria

```
"dtl", "EasyConverter /s Voltage.lgs $(PathName)", "*", "Voltage"  
"dtl", "EasyConverter /c $(PathName)", "EasyView"  
"dtl", "EasyConverter /c $(PathName)", "192.168.1.26"  
"dtl", "EasyConverter /c $(PathName)"  
"evt", "EasyConverter /c $(PathName)"
```

Chapter 27 EasySimulator

EasySimulator enables users to perform On-line/Off-line Simulation without installing EasyBuilder Pro software. To achieve that, users have to prepare the following files in one folder.

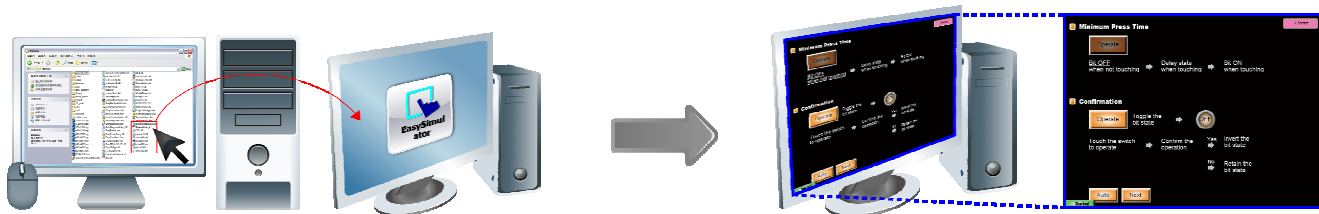

27.1 Prepare Needed Files

1. [driver] → [win32]
2. 320x234.bmp
3. 480x234.bmp
4. 480x272.bmp
5. 640x480.bmp
6. 800x480.bmp
7. 800x600.bmp
8. 1024x768.bmp
9. 234x320.bmp
10. 272x480.bmp
11. 480x800.bmp
12. 600x800.bmp
13. com.exe
14. EasySimulator.exe
15. gui.exe
16. xob_pos.def

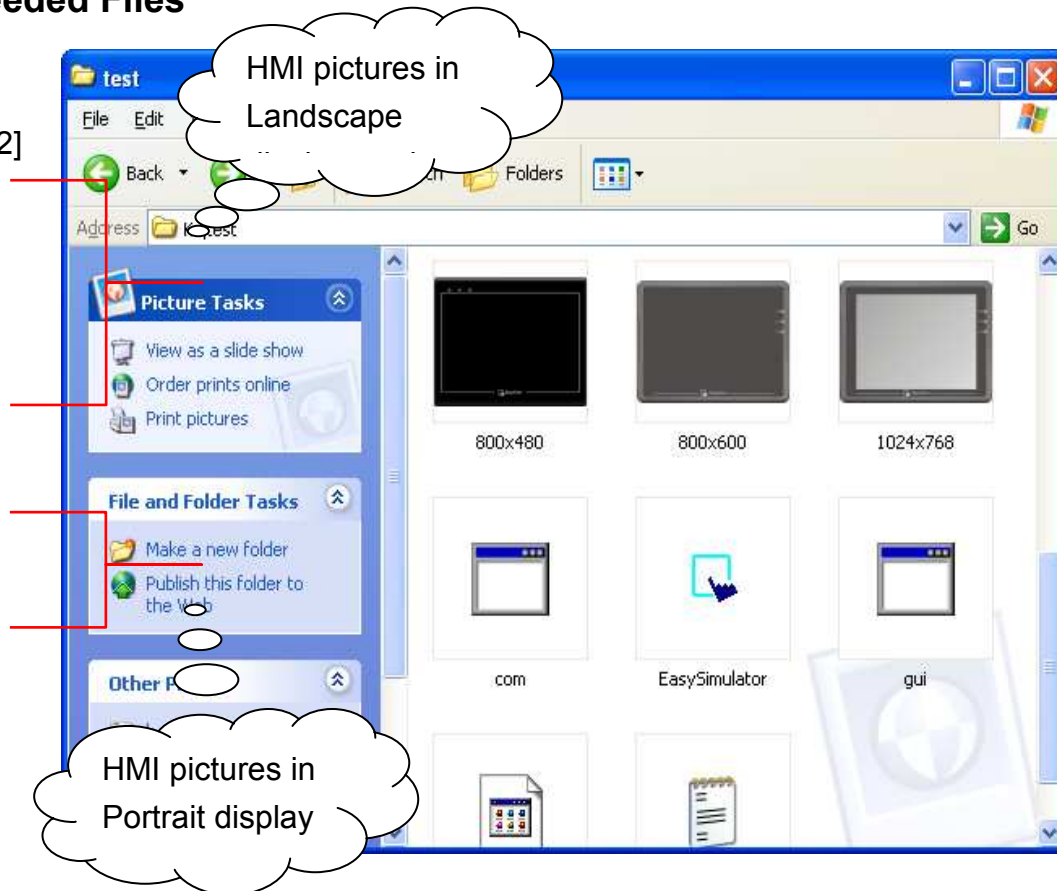



■ Users can find all the above files in EasyBuilder Pro installation directory, which means users have to install EasyBuilder Pro software package on a PC first then copy the needed files to the target PC.

27.2 Modify the Content of “xob_pos.def”

Step 1

Open xob_pos.def using a text editing tool (e.g. Notepad) and set the contents correctly.

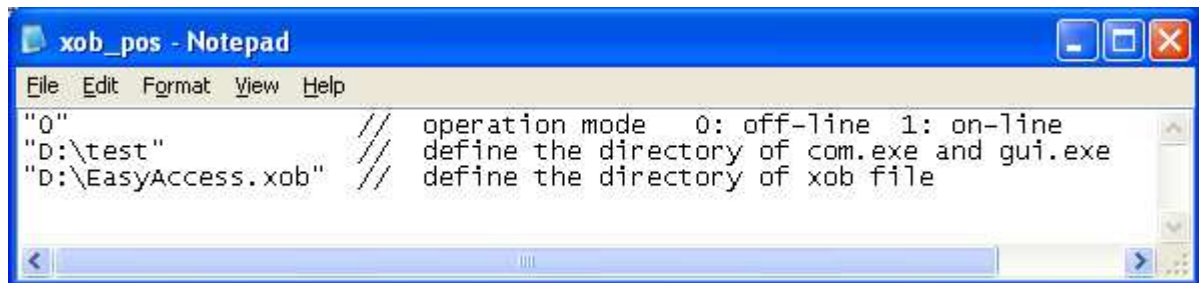

```

xob_pos - Notepad
File Edit Format View Help
"0" // operation mode 0: off-line 1: on-line
"D:\test" // define the directory of com.exe and gui.exe
"D:\EasyAccess.xob" // define the directory of xob file
    
```

Line no.	Description
1	["0"] Perform Off-line Simulation; ["1"] Perform On-line Simulation
2	Specify the full path where the files locate. (e.g. com.exe, gui.exe, EasySimulator.exe...etc.)
3	Specify the full path of the project file. (*.xob)

Step 2

Double click on EasySimulator.exe to start simulation.

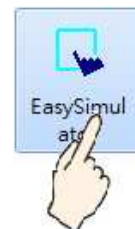

Step 3



On-line /



Off-line Simulation is displayed on the screen.



- If EasySimulator.exe can't be activated, please check if the relevant directories are correctly defined.
- If the window below is shown, it indicates there's an error in *.xob file directory, please check if it is correctly defined.

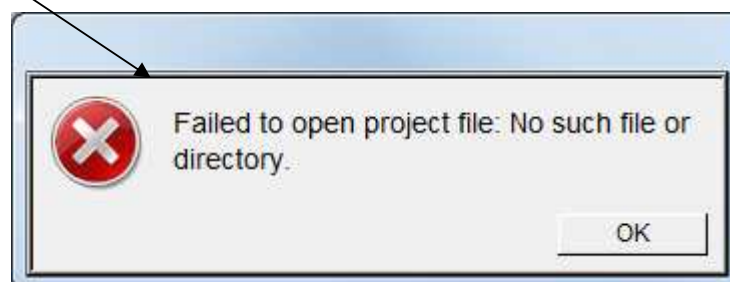

Chapter 28 Multi-HMI Intercommunication (Master-Slave Mode)

Multi-HMI intercommunication means that HMI uses COM port to connect with a remote HMI, and read/write data from/to PLC connected to remote HMI as



below:

The above shows the PLC is connected with HMI 1, and HMI 1 is connected with HMI 2 via COM port, so that HMI 2 can control the PLC through HMI 1.

The following are examples of how to use EasyBuilder Pro to create projects used on HMI 1(Master) and HMI 2 (Slave).

28.1 How to Create a Project of Master HMI

The following is the project content of HMI 1 in **[System Parameter Settings] / [Device]**.



1. Due to COM 1 of HMI 1 connects PLC, the device list must include **[Local PLC 1]** in this case is “FATEK FB Series”. The communication parameters must be set correctly.

2. Due to COM 2 of HMI 1 is used to receive commands from HMI 2; a new device must be added– **[Master-Slave Server]** for setting communication properties of COM 2. The picture above shows the parameters of COM 2– “115200, E, 8, 1”, and uses RS232. These parameters are not required to be the same as PLC, but the **[Data bits]** must be set to **8**. In general, a higher baud rate for COM 2 is recommended for a more efficient communication with PLC.

28.2 How to Create a Project of Slave HMI

The project content of HMI 2 in [System Parameter Settings] / [Device].



Due to the PLC that HMI 2 reads from is connected with HMI 1, thus HMI 2 views PLC as a remote device. Therefore, it is necessary to add a [***Remote PLC 1**] into the device list and in this case is "FATEK FB Series". The way to create [***Remote PLC 1**] is described below:

1. Create a new device "FATEK FB Series". [**PLC default station no.**] must be the same as the connected PLC.

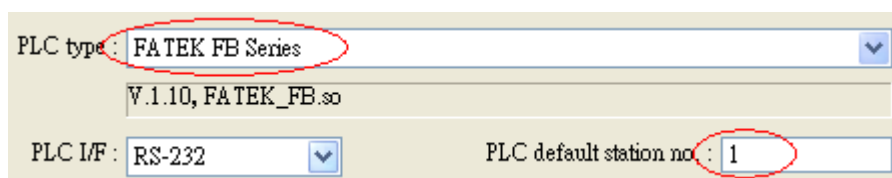

2. Correctly set the parameters. COM 1 of HMI 2 connects with COM 2 of HMI 1, so they both must have the same communication parameters and interfaces, ignoring the PLC parameters. As below, COM 2 of HMI 1 and COM 1 of HMI 2 use RS232 and the parameters - [115200, E, 8, 1].

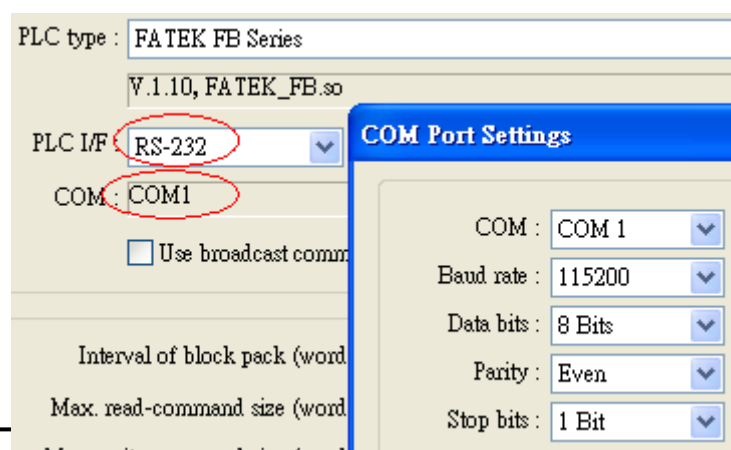

3. Since HMI 2 views PLC a remote device, here we change **[Location]** to **[Remote]**, and select **[COM port]** to connect remote HMI (HMI 1).

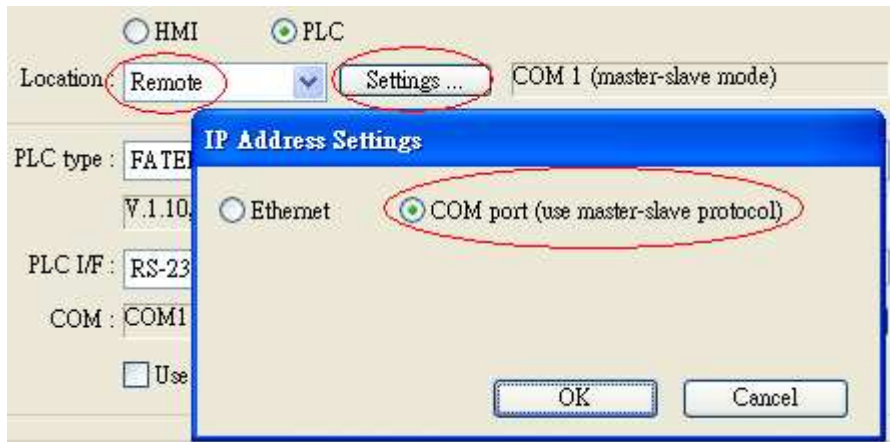

Device list :

No.	Name	Location	Device type	Interface
Local HMI	Local HMI	Local	MT6056T/MT8056T...	Disable
*Remote PLC 1	FATEK FB Series	COM 1 (master-slave mode)	FATEK FB Series	COM1 (11520)

4. Upon completion of the settings, users can find a new device named **[*Remote PLC 1]** in the **[Device List]**. This device has a “*” symbol, which means, even if it contains “Remote” in the name, it actually gives commands and gets replies through a local COM port, and therefore the connection with PLC can be viewed from a local system reserved register, that is, [*Remote PLC 1], [*Remote PLC 2], [*Remote PLC 3] and [Local PLC 1], [Local PLC 2], [Local PLC 3] use the same system reserved register from the listed below:

Tag	Description
LB-9150	When ON, auto. connection with PLC (COM 1) when disconnected. When OFF, ignore disconnection with PLC.
LB-9151	When ON, auto. connection with PLC (COM 2) when disconnected. When OFF, ignore disconnection with PLC.
LB-9152	When ON, auto. connection with PLC (COM 3) when disconnected. When OFF, ignore disconnection with PLC.

LB-9200~ LB-9455	<p>These local registers indicate the connection states with PLC (through COM1). LB9200 indicates the connection state with PLC (station no. 0), and LB9201 indicates the connection state with PLC (station no. 1) and so on. When ON, indicates connection state is normal. When OFF, indicates disconnection with PLC. Set ON again, the system will then try to connect with PLC.</p>
LB-9500~ LB-9755	<p>These local registers indicate the connection states with PLC (through COM2). LB9500 indicates the connection state with PLC (station no. 0), and LB9501 indicates the connection state with PLC (station no. 1) and so on. When ON, indicates connection state is normal. When OFF, indicates disconnection with PLC. Set ON again, the system will then try to connect with PLC.</p>
LB-9800~ LB-10055	<p>These local registers indicate the connection states with PLC (through COM3). LB9800 indicates the connection state with PLC (station no. 0), and LB9801 indicates the connection state with PLC (station no. 1) and so on. When ON, indicates connection state is normal. When OFF, indicates disconnection with PLC. Set ON again, the system will then try to connect with PLC.</p>

28.3 How to Connect with MT500 Project of Slave HMI

It allows MT500 using EB500 Master-Slave protocol to read EB Pro HMI Local Data and the data of the connected PLC.

■ EB Pro Settings

1. Select “Master-Slave Server” driver and click **[Settings]**. If a PLC is connected, follow the original settings.

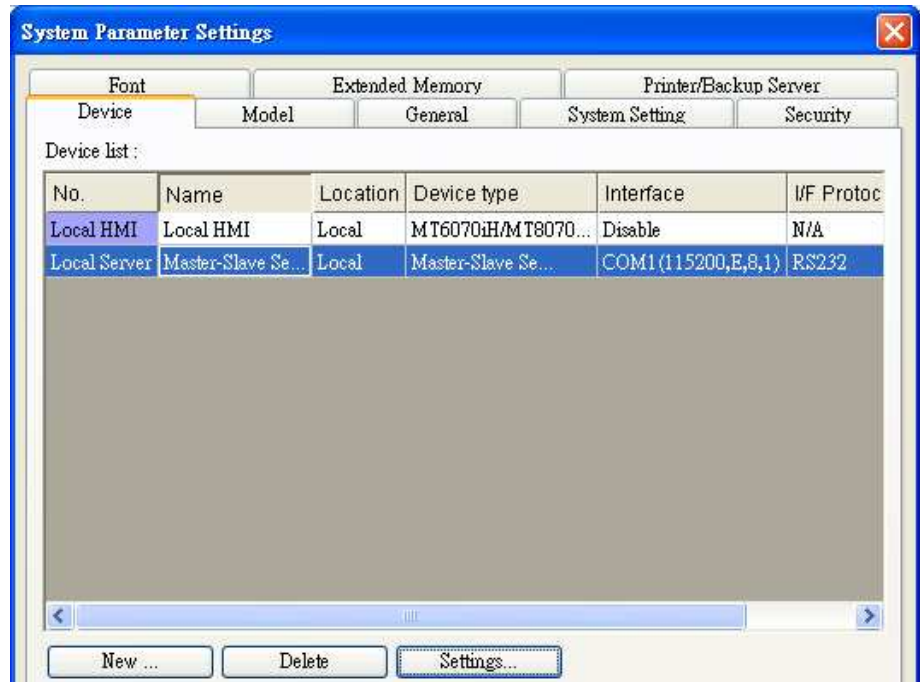

2. Select **[RS-232]**, click **[Settings]**.

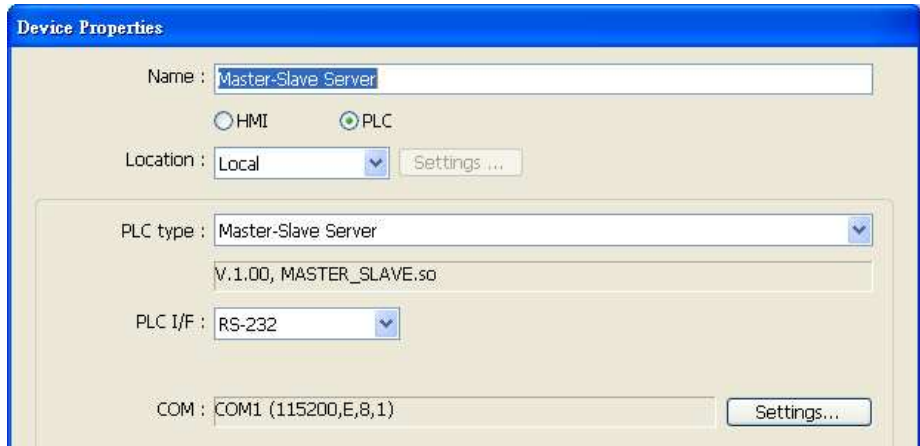

3. Fill in MT500 PLC ID No. in **[Parameter 1]** (Refer to MT500 settings).

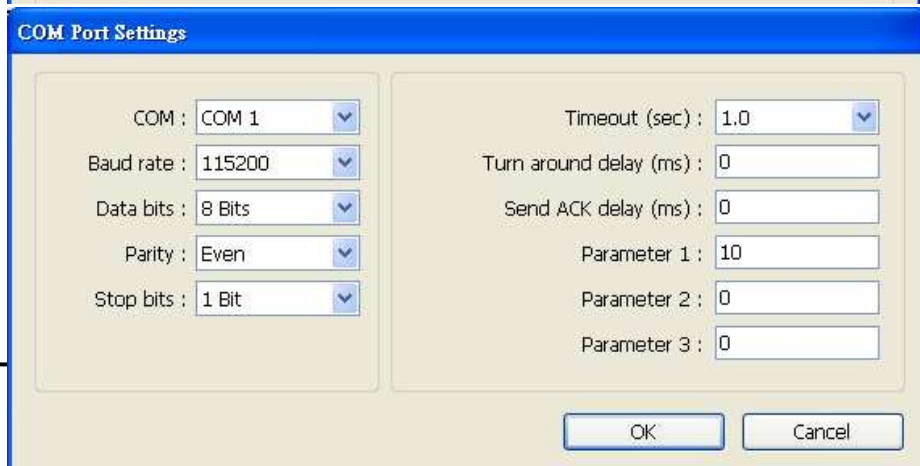

■ EB500 Settings

1. In EB500 System Parameter Settings, set Multiple HMI: Slave, HMI-HMI link speed: 115200



■ **[Baud rate]** must be the same in EB500 and EB Pro.

System Parameter Setting

PLC type: MITSUBISHI FX0n/FX2

HMI model: MT510T/MT508T (640 x 480)

PLC I/F port: RS-485 4W Baud rate: 9600

Data bits: 7 Bits Parity: Even

Stop bits: 1 Bit

Parameter 1: 0 Turn around delay: 0

Parameter 3: 0 Parameter 4: 0

Parameter 5: 0 Parameter 6: 0

HMI station no.: 0 PLC station no.: 0

Multiple HMI: Slave HMI-HMI link speed: 115200

Connect I/F: Serial

Local IP address: 0 . 0 . 0 . 0

Server IP address: 0 . 0 . 0 . 0

Subnetwork mask: 0 . 0 . 0 . 0

Default route IP address: 0 . 0 . 0 . 0

PLC time out constant (sec): 3.0 PLC block pack: 3

OK Cancel Apply Help

2. Double click on PLC Address View.exe to check PLC ID No. and fill in **[Parameter 1]** of EB Pro.

PLCAddressView

MITSUBISHI FX0n/FX2

PLC/Address Type ID	Bit/Word	Address Type	Addressing Format	Max	Min
MITSUBISHI FX0n/FX2	PLC ID=10				
0	Bit(HMI)	LB	ddd	9999	0
1	Bit(PLC)	X	ooo	377	0
2	Bit(PLC)	Y	ooo	377	0
3	Bit(PLC)	M	ddd	9999	0
4	Bit(PLC)	T	ddd	255	0
5	Bit(PLC)	C	ddd	255	0
8	Word(HMI)	LW	ddd	9999	0
9	Word(PLC)	TV	ddd	255	0
10	Word(PLC)	CV	ddd	199	0
11	Word(PLC)	D	ddd	9999	0
12	DWord(PLC)	CV2	ddd	255	200
13	Word(PLC)	SD	ddd	9999	8000
121	Word(HMI)	RWI	ddd	32767	0
120	Bit(HMI)	RBI	ddd(h)	2047f	0
140	Bit(HMI)	RB	ddd(h)	2047f	0
141	Word(HMI)	RW	ddd	65535	0
160	Bit(HMI)	Ms_RB	ddd(h)	4095f	0
161	Bit(HMI)	Ms_LB	ddd	9999	0
180	Word(HMI)	Ms_RW	ddd	65535	0

Exit

3. Connect COM ports RS232 of each HMI, the

communication is then enabled.



- There will always be a PLC selected in EB500 system parameter settings, in this case, even to read/write EB Pro HMI Local Data only, the ID of the selected PLC in EB500 system parameters must also be filled in EB Pro parameter 1.
- When using S7-200, S7-300 drivers, since in EB500 the high and low bytes are sent in reverse order, this will cause MT500 to misread EB Pro HMI Local data.

Device address:

Bit/Word	EB500	EB Pro	Range	Memo
B	Ms_RB	RW_Bit	dddd: 0~4095 (h): 0~f	
B	Ms_LB	LB	dddd: 0~9999	
W	Ms_RW	RW	dddd: 0~65535	
W	Ms_LW	LW	dddd: 0~9999	

Chapter 29 Pass-Through Function

The pass-through function allows the PC application to control PLC via HMI. In this case the HMI acts as a converter.

The pass-through function provides two modes: **[Ethernet]** and **[COM port]**. Click **[Pass-through]** in **[Project Manager]** will open a setting dialogue.

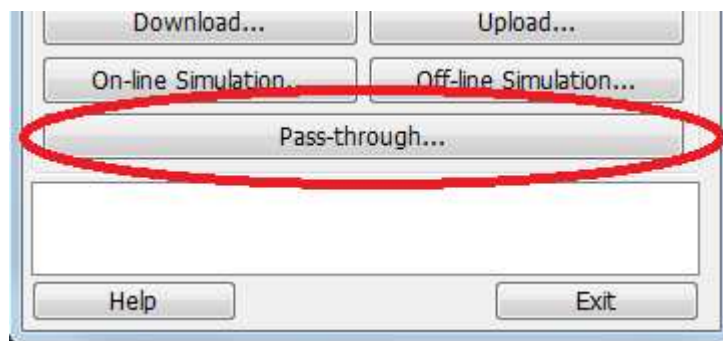

29.1 Ethernet Mode

[How to install virtual serial port driver]

Before using [Ethernet] mode, please check whether Weintek virtual serial port driver is installed as described below:

If [Virtual COM port (PC<->PLC)] displays [Please install weintek virtual serial port driver], please click [Install].



If the dialogue below pops up during installation, please click [Continue Anyway].



After process is completed, the virtual COM port is displayed as follow.

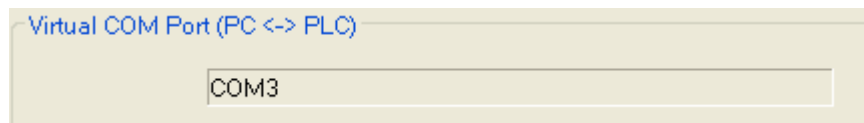

29.1.1 How to Change the Virtual Serial Port

Open [System Properties] -> [Device Manager] to check if the virtual serial port is installed successfully.

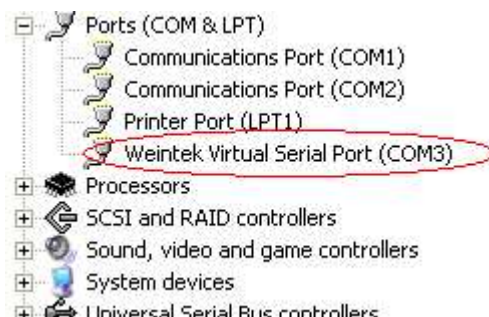

If users want to change the number of virtual serial port, please click [Weintek Virtual Serial Port] to open [Port Settings] / [Advanced...], as follows:

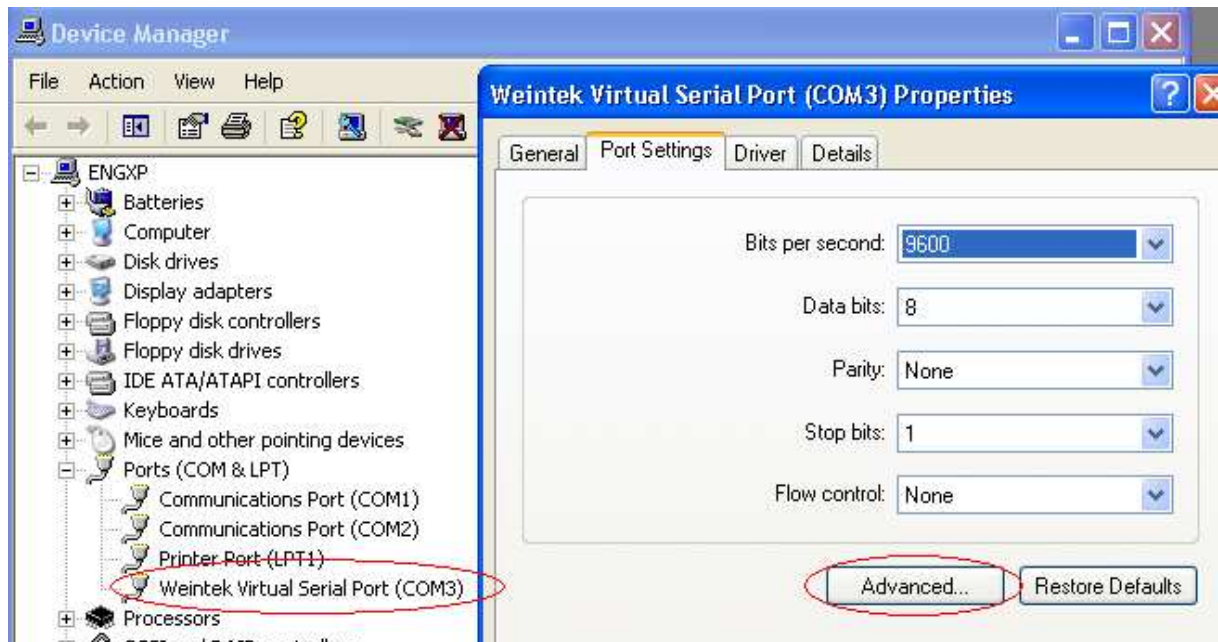

For example, user changes virtual serial port from COM 3 to COM 9.

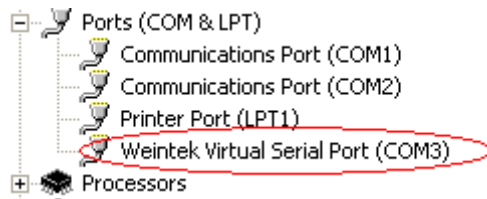

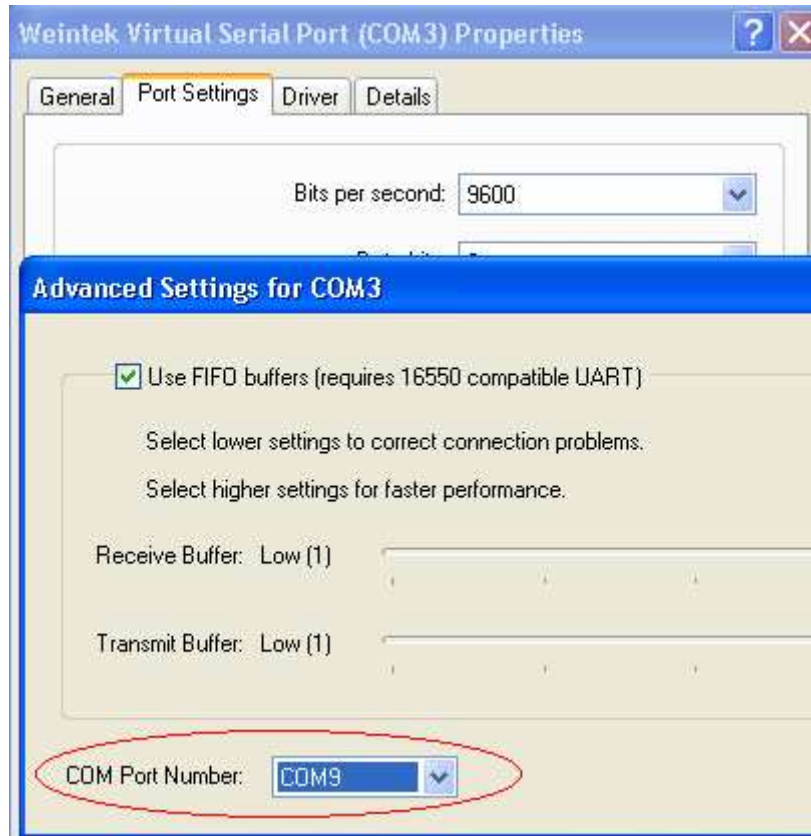

Select COM 9 and click **[OK]**, the virtual serial port will be changed to COM 9.

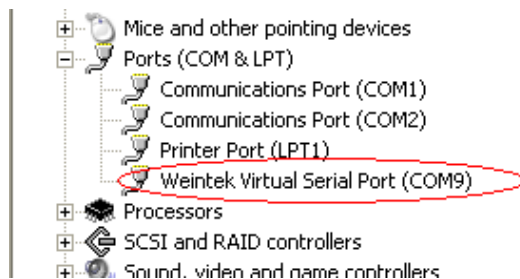

It can be found that the virtual COM port be changed to COM 9 in **[Project Manager]**.

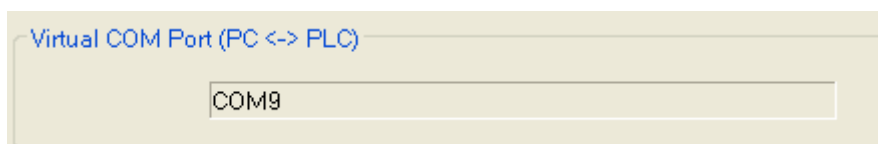

29.1.2 How to Use Ethernet Mode

After installing virtual serial port driver, users should follow four steps to use Ethernet mode of pass-through.

Step 1

Set IP of the HMI connected with PLC. For example, HMI IP is 192.168.1.206

Step 2

Assign serial port properties of the port connects HMI with PLC. For example, COM2 (use RS232) is used to connect PLC.

Step 3

Click **[Apply]**, and these settings will be updated.

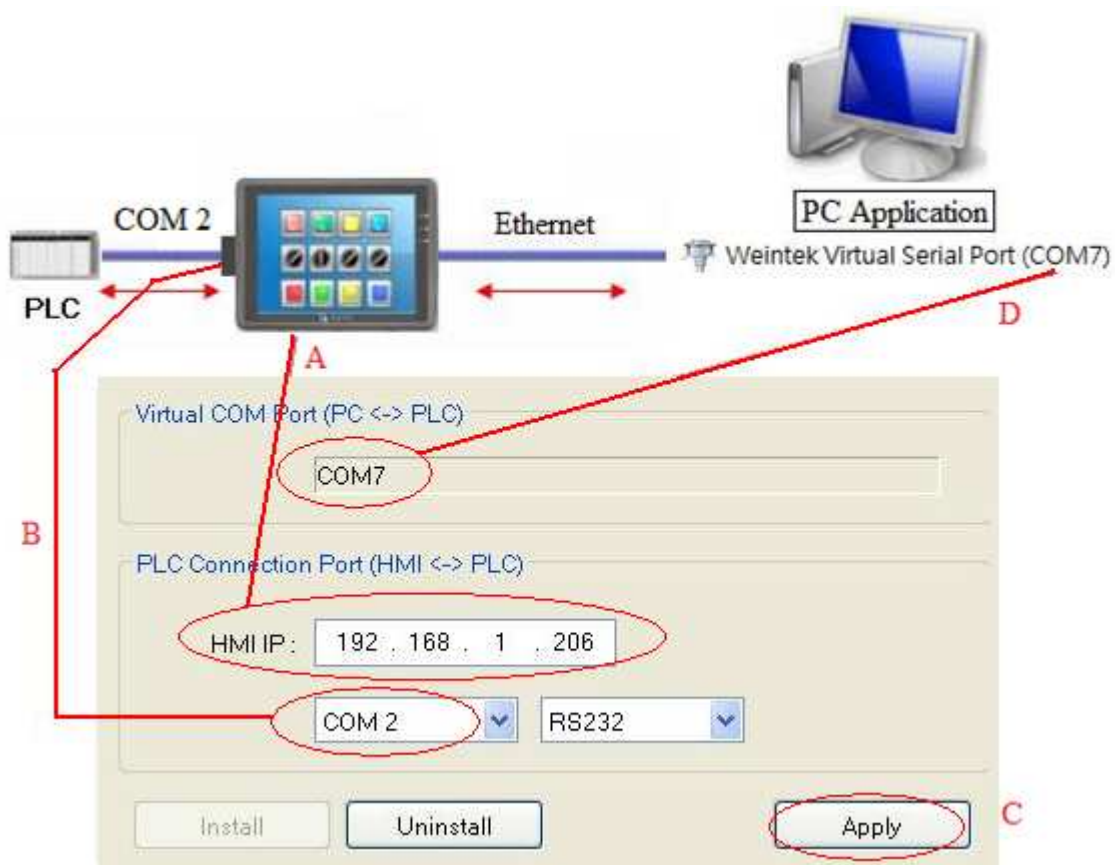

Step 4

In the PC application, the number of the serial port must be the same as the virtual one. For example, using a Mitsubishi application, if the virtual serial port

is COM 7, please open **[PC side I/F Serial setting] / [COM port]** to select COM 7, as follows:

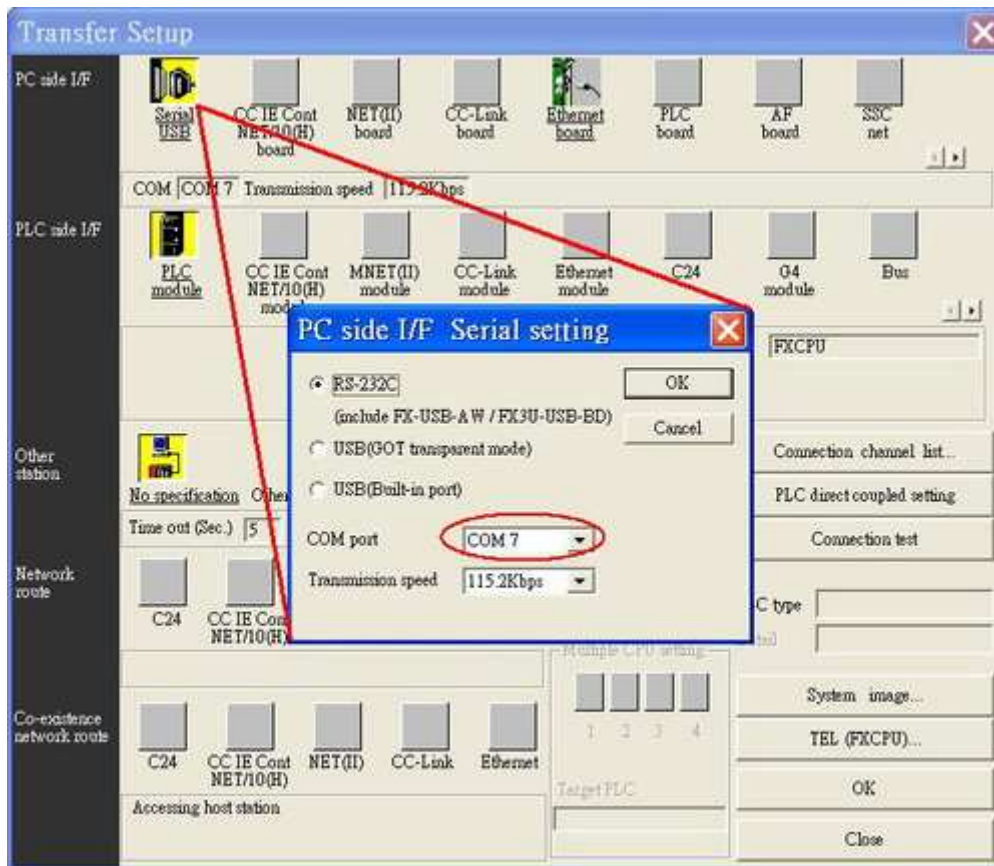

After completing all settings, when users execute PLC application on PC, the HMI will be switched automatically to pass-through mode (the communication between HMI and PLC will be suspended this moment and it will be resumed if the application closes), as follows:



At this moment the application is controlling PLC directly via virtual serial port.

29.2 COM Port Mode

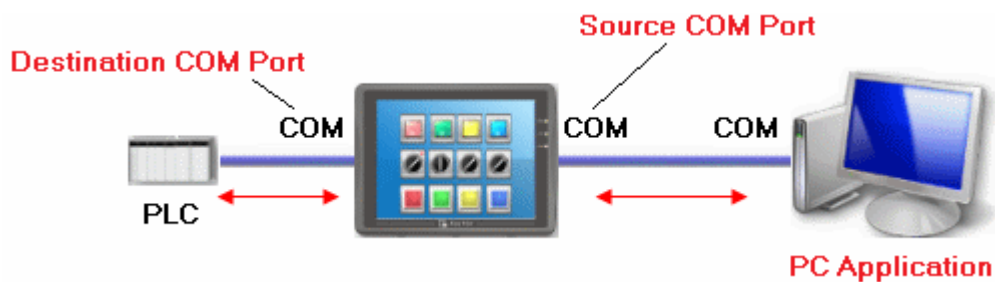

Source COM Port

The port is used to connect HMI with PC.

Destination COM Port

The port is used connect HMI with PLC.

When using **[COM port]** mode of pass-through, users should correctly set the properties of source COM port and Destination COM port.

29.2.1 Settings of COM Port Mode

There are two ways to enable **[COM port]** mode of pass-through function.

(1) **Use Project Manager**

(2) **Use system registers LW-9901 and LW-9902**

LW-9901: pass-through source COM port (1~3: COM1~COM3)

LW-9902: pass-through destination COM port (1~3: COM1~COM3)

Note: When finish using Pass Through function, users should click [Stop Pass-through] to disable it so that HMI can start to communicate with PLC

Start pass-through in project manager.

Click **[Pass-through]** button in Project Manager to set the communication parameters.

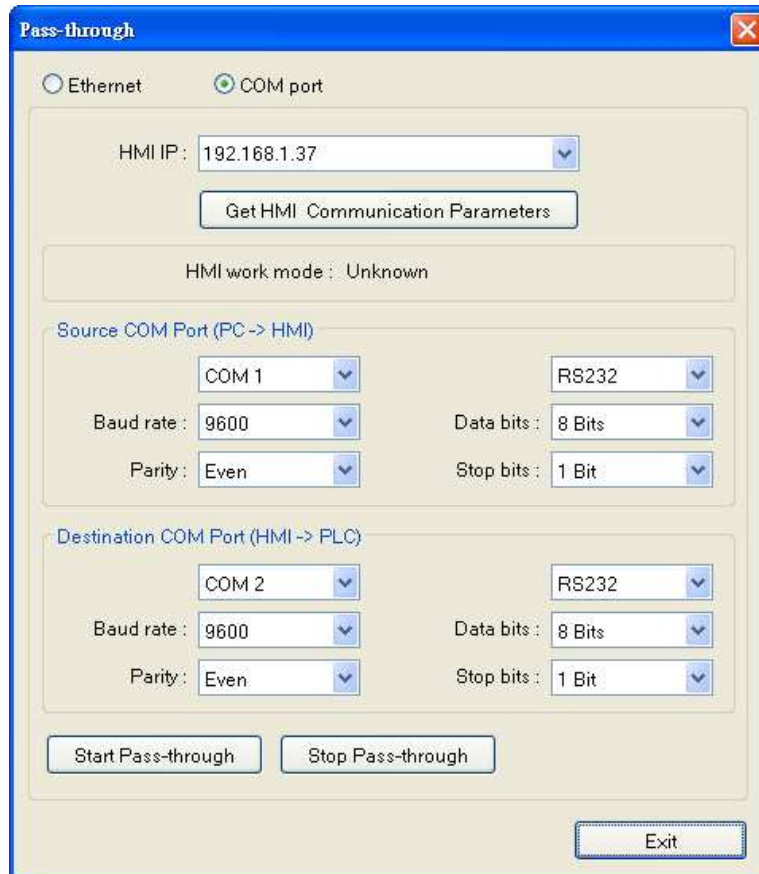

[HMI IP]

Assign HMI IP address.

[Get HMI Communication Parameters]

For getting the settings of source and destination COM port. The parameters come from reserved addresses detailed as follows.

Source COM port and Destination COM port

LW-9901 (Source COM port)	1 : COM 1	2 : COM 2	3 : COM 3
LW-9902(Destination COM port)	1 : COM 1	2 : COM 2	3 : COM 3

COM 1 mode settings

LW-9550 (PLC I/F)	0 : RS232	1 : RS485/2W	2 : RS485/4W
LW-9551 (baud rate)	0 : 4800	1 : 9600	2 : 19200
	3 : 38400	4 : 57600	5 : 115200
LW-9552 (data bits)	7 : 7 bits	8 : 8 bits	
LW-9553 (parity)	0 : none	1 : even	2 : odd

LW-9554 (stop bits)	1 : 1 bit	2 : 2 bits
---------------------	-----------	------------

COM 2 mode settings

LW-9555 (PLC I/F)	0 : RS232	1 : RS485/2W	2 : RS485/4W
LW-9556 (baud rate)	0 : 4800 38400	1 : 9600	2 : 19200 3 : 57600 5 : 115200
LW-9557 (data bits)	7 : 7 bits	8 : 8 bits	
LW-9558 (parity)	0 : none	1 : even	2 : odd
LW-9559 (stop bits)	1 : 1 bit	2 : 2 bits	

COM 3 mode setting

LW-9560 (PLC I/F)	0 : RS232	1 : RS485/2W
LW-9561 (baud rate)	0 : 4800 38400	1 : 9600 2 : 19200 3 : 57600 5 : 115200
LW-9562 (data bits)	7 : 7 bits	8 : 8 bits
LW-9563 (parity)	0 : none	1 : even 2 : odd
LW-9564 (stop bits)	1 : 1 bit	2 : 2 bits

Click [**Get HMI Communication Parameters**] to update HMI current states and communication parameters.

29.2.2 HMI Work Mode

There are three work modes in the pass-through function,

Mode	Description
Unknown	Before getting the settings of HMI, the work mode is displayed "Unknown".
Normal	After getting the settings of HMI, if work mode displays "Normal" PC can't control PLC via HMI.
Pass-through	HMI is working on pass-through state; at this time, the PC application can control PLC via source com port.

[Source COM Port], [Destination COM Port]

The communication parameters of source and destination COM port are displayed in these two areas. The settings will be used when **[Start pass-through]** is clicked.

The “Baud rate”, “Data bits”, “Parity”, and “Stop bits” of [Source COM Port] and [Destination COM Port] have to be the same.

[Source COM Port] connects PC, so select RS232 mode; [Destination COM Port] connects PLC, so settings depend on the PLC requirements.

The illustration below shows the setting when HMI connects SIEMENS S7/200.

The HMI COM 1 (RS232) connects PC, COM 3 (RS485 2W) connects PLC. The communication parameter of PLC is “9600, E, 8, 1”. Before starting pass-through, users must set the parameters in MTP project and download the project to HMI.

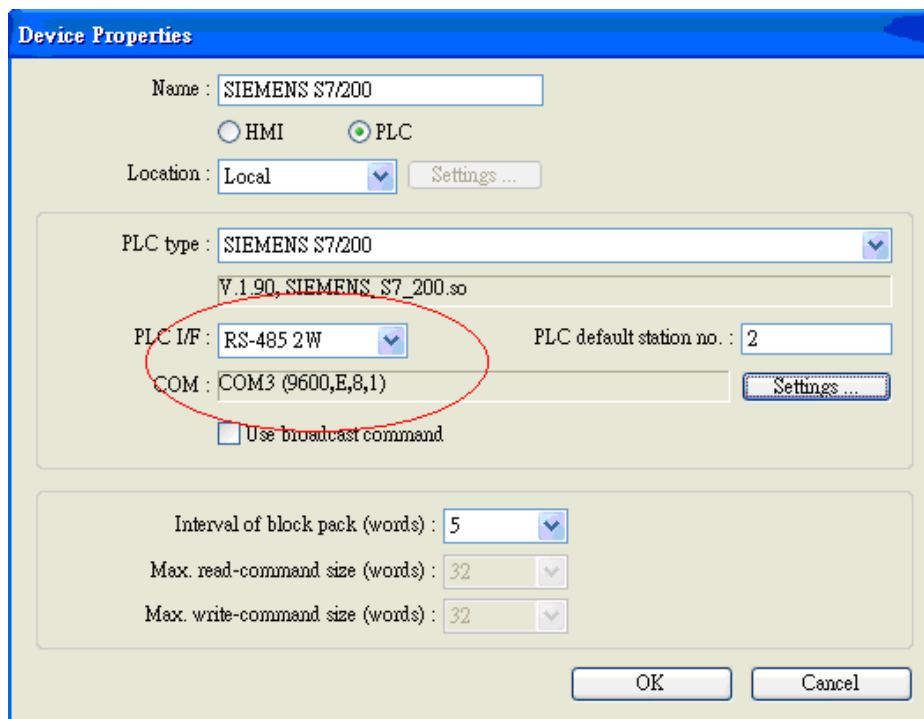

After the project is downloaded to HMI, open the same project and change the PLC I/F and COM port to COM 1 RS232 (PC uses COM 1 to connect HMI) as follows:

Device Properties

Name : SIEMENS S7/200

HMI PLC

Location : Local Settings...

PLC type : SIEMENS S7/200
V.1.90, SIEMENS_S7_200.so

PLC I/F : RS-232 Settings... PLC default station no. : 2

COM : COM1 (9600,E,8,1) Settings...

Use broadcast command

Interval of block pack (words) : 5

Max. read-command size (words) : 32

Max. write-command size (words) : 32

OK Cancel

After that, press **[Pass-through]** to assign HMI IP address; for example, 192.168.1.37. Finally, press **[Get HMI Communication Parameters]**, as follows:

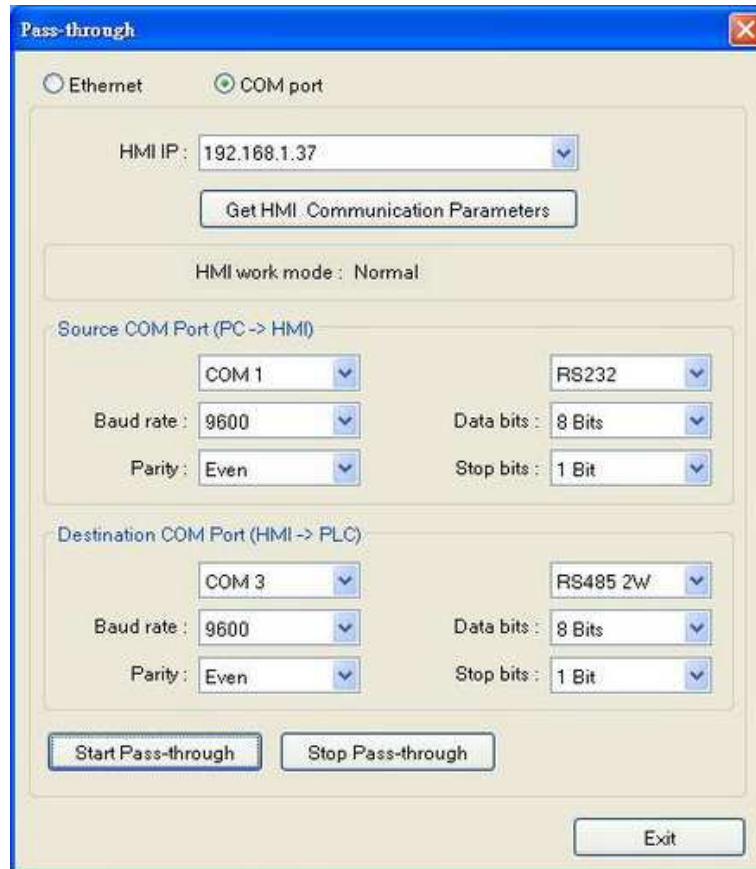

Press **[Start Pass-through]** and HMI work mode is switched into “Pass-through”. Users can execute on-line simulation. Now PC application can control PLC via HMI, and HMI is acting as a converter at this moment.

Note: The communication between HMI and PLC will be paused when pass-through is active. If users want to resume communication between HMI and PLC, please press **[Stop Pass-through]** to disable this function.

29.3 Using System Reserved Addresses to Enable Pass-Through Function

Other way to enable pass-through is to use LW-9901/LW-9902 to set source COM port and destination COM port directly. When the values of LW-9901 and LW-9902 match conditions as below, HMI will start pass-through automatically:

- a. The values of LW-9901 and LW-9902 have to be 1 or 2 or 3 (1: COM 1, 2: COM 2, 3: COM 3).
- b. The values of LW-9901 and LW-9902 should not be the same.

Note: If users want to stop pass-through, just change the values of LW-9901 and LW-9902 to 0.

If users need to change the communication parameters, just change the value in related reserved addresses and set ON to LB-9030, LB-9031 and LB-9032. HMI will be forced to accept new settings.

Tag	Description
LB-9030	Update COM1 communication parameters (set ON)
LB-9031	Update COM2 communication parameters (set ON)
LB-9032	Update COM3 communication parameters (set ON)

Chapter 30 Project Protection

The copyright of program design must be protected. EasyBuilder Pro supports protection functions for project files to ensure users' design achievement.



- The following protection functions can't be decrypted by factory since they are encrypted by users, therefore, please remember your password.

30.1 XOB Password

After project (MTP) is completed, users can compile the file to XOB format that can be downloaded to HMI. Password can be set to protect the XOB file in **[Compiling]** window.

A password will be required when attempting to decompile the XOB file to MTP. (XOB password range: 0 ~ 4294901760)

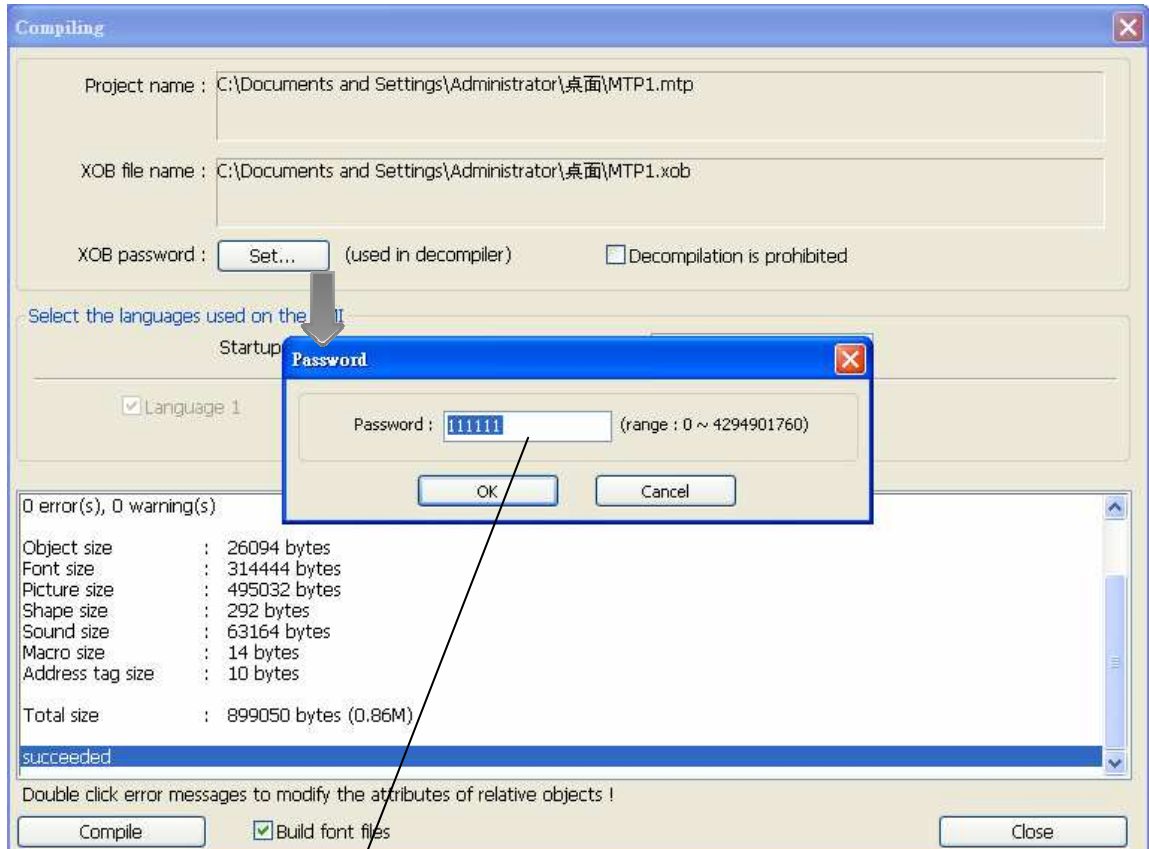

If the password is input incorrectly for three times when decompiling, please reset the decompiler.

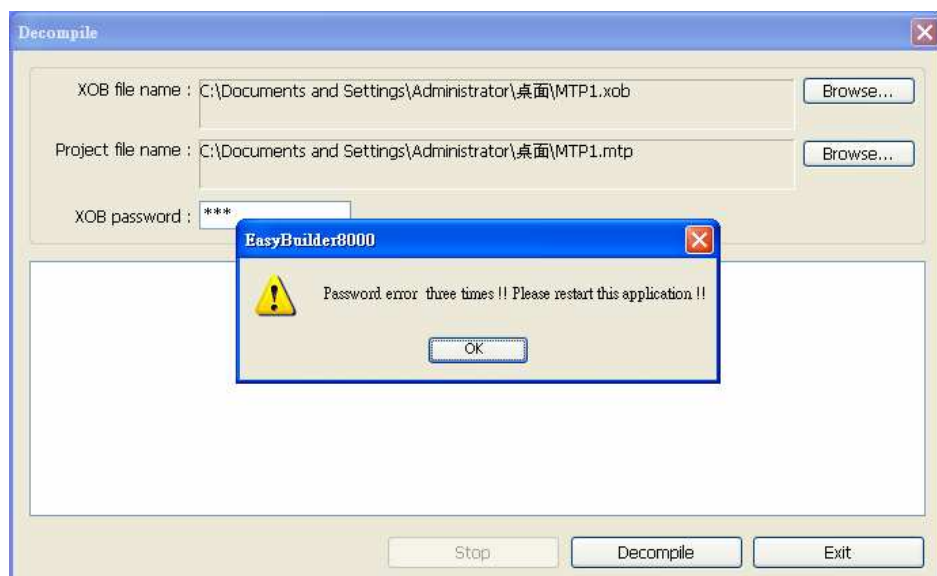

30.2 Decompilation is Prohibited

If this box is ticked, the system will automatically deny **[XOB password]**. Furthermore, the XOB file can't be decompiled to MTP file.

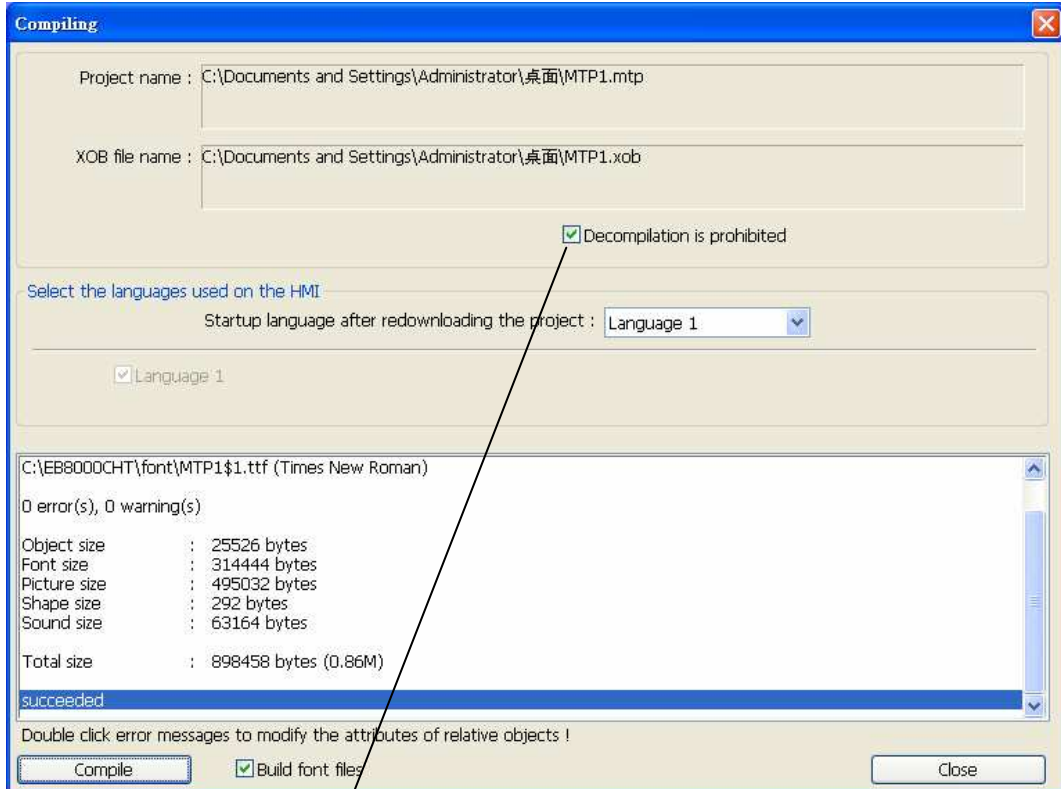

When attempting to decompile a XOB file that is already set to **[Decompilation is prohibited]**, an error message “**This xob is set to not decompile!!**” will be shown.

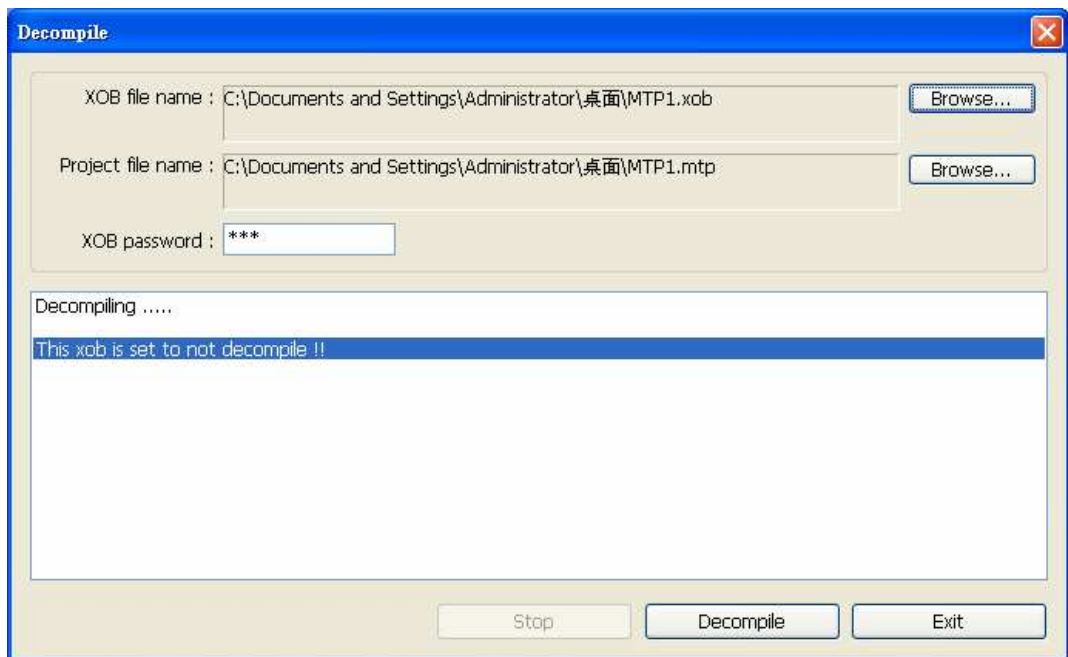

30.3 Disable HMI Upload Function [LB-9033]

EasyBuilder Pro provides system reserved address [LB-9033]. When this address is set to ON, HMI will disable upload function of XOB file. HMI needs to be rebooted to activate [LB-9033].

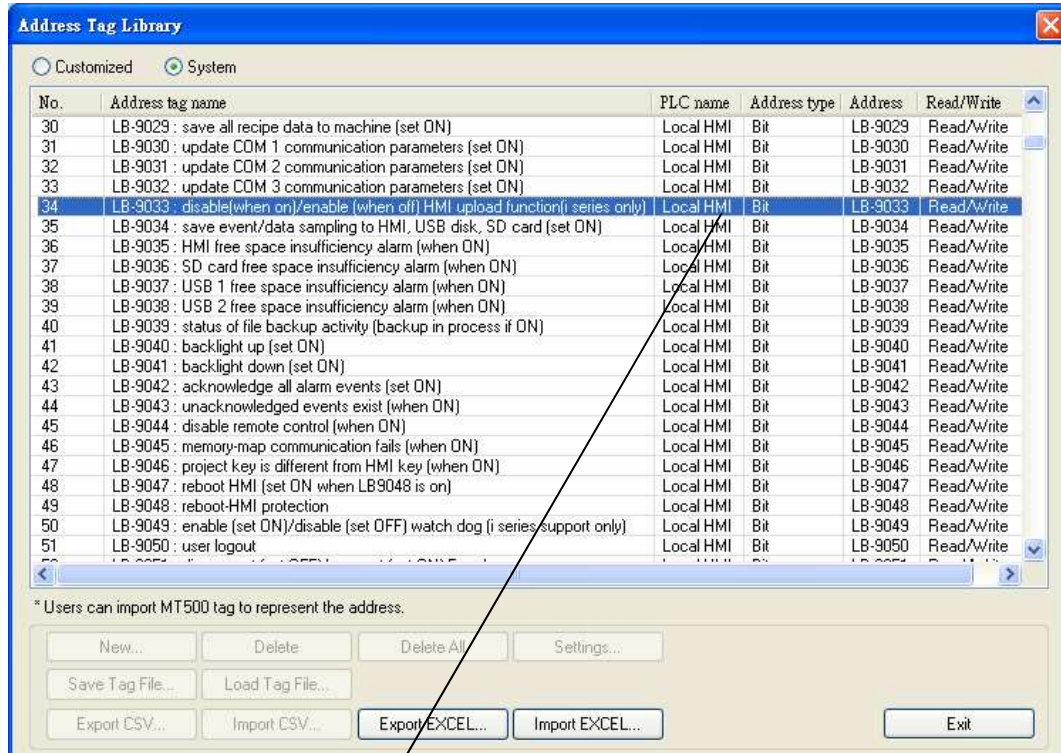

When attempting to upload a XOB file set to this function, the XOB file gained after uploading will be 0 bytes.

30.4 Project Key

User's project can be restrained to be executed only on specific HMI (for i series HMI only).

Please go to **[System Parameters Settings] / [General] / [Project protection]**.

Project protection (i series only)

Enable Project key : (range : 0 ~ 4294901750)

* If this key is different from HMI key, the project won't be executed normally.
* Use LW9046~9047 to change HMI key. LB9046 indicates check result (key error when status is on).

LW-9046 ~ LW-9047 (32-bit) can be used to set the **[HMI key]**. The value can't be read or written into these two registers by remote HMI. While using this function, set the password (**[Project key]** password range: 0 ~ 4294901750), and the XOB file can only be executed on specific HMI when [HMI key] and [Project key] are identical. If they are different, the system will turn LB-9046 ON. HMI needs to be rebooted every time when revising [HMI key].



- When [HMI key] and [Project key] are different, HMI and PLC won't be able to communicate.



Please confirm your Internet connection before downloading the demo project.

30.5 Project Password (MTP file)

Password can be set to protect the MTP file in **[System parameter] / [Security]** tab.

Enabling this, password will be required if attempting to edit MTP file. (MTP password range: 1 ~ 4294967295)

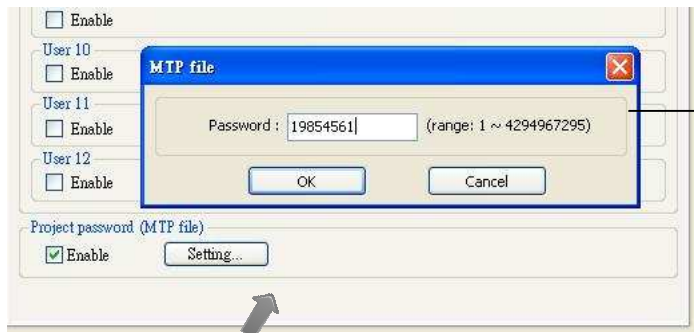

After setting, when opening this project, a pop-up window requires to input password will be shown.



- When using “Window Copy” function, if the source file is protected by MTP password, please input correct password for EasyBuilder Pro to execute window copy.

Chapter 31 Memory Map Communication

MemoryMap communication protocol is similar to IBM 3764R, it is used when memory data is with low variation. (High variation may cause MemoryMap overloading.) MemoryMap is used for communication between two devices. When setting the MemoryMap with two devices, one has to be set as Master, and another is Slave. In normal condition, Master and Slave do not communicate except when the assigned memory data in one of them has changed. Once data is identical the communication will stop.. So this is used for keeping the consistency of assigned part of data between two devices (Master and Slave) via corresponding registers.

The corresponding memory has the same property as MT8000's register MW(MB) from Master and Slave (The 1000 words MW(MB) are reserved for MemoryMap in MT8000 for communication.) The feature of memory: MB is correspondence with MW, according to the following list, MB0~MBf and MW0, MB10~MB1f and MW1..., they all indicate the same register.

Device name	Format	Range
MB	dddd(h)	dddd:0~9999 h:0~f(hex)
MW	dddd	dddd:0~9999

When using MemoryMap communication protocol, the master and slave have to use the same communication setting. The wiring diagram as follow:

RS232	
Master	Slave
TX(#)	RX(#)
RX(#)	TX(#)
GND(#)	GND(#)

RS485 (4W)	
Master	Slaver
TX+(#)	RX+(#)
TX-(#)	RX-(#)
RX+(#)	TX+(#)

RX-(#)	TX-(#)
GND(#)	GND(#)

Note: # means being decided by PLC or controller.

The flowchart of communication as following:

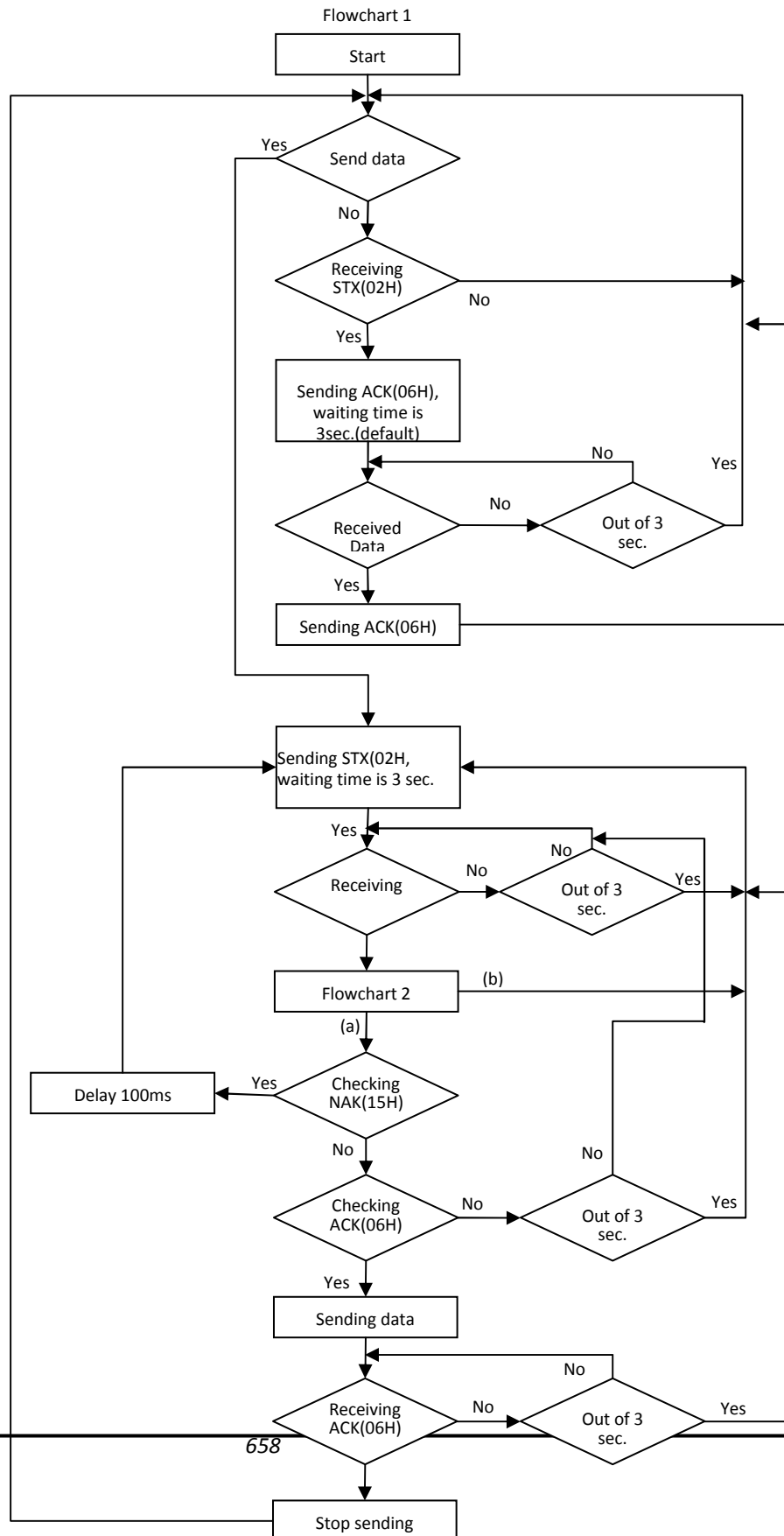

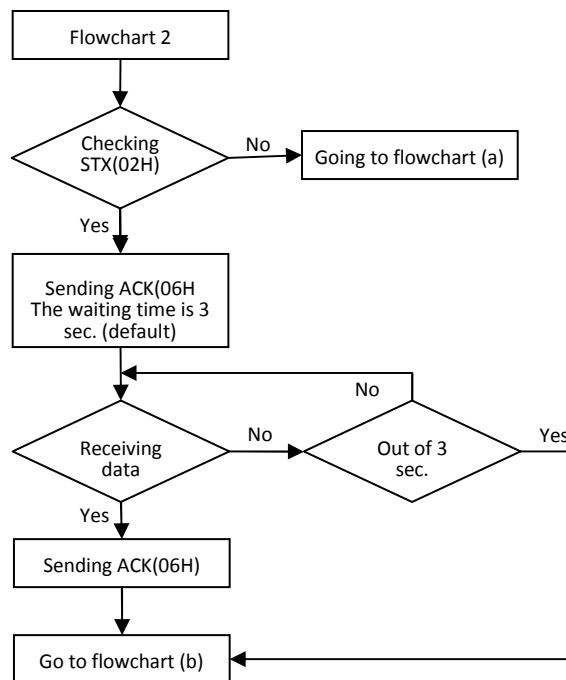
Caution:

Flowchart 2 is available for slave but not master, STX is asking signal for communication, ACK is feedback signal, and NAK is busy signal.

There are two data formats, one is for MB and another is for MW:

For MB command		
Offset (byte)	Format	Description
0	0x02	The operating sign to MB
1	0x##	Address (Low byte)
2	0x##	Bit Address (High byte) For example:MB12=>1*16+2=18, is 0x12 and 0x00
3	0x00(or 0x01)	The data of MB address. (This is Bit, so has to be 0 or 1)
4 , 5	0x10 , 0x03	Stop sign
6	0x##	checksum, xor from 0 byte to fifth byte.

For MW command		
Offset(byte)	Format	Description
0	0x01	The operating sign to MW
1	0x##	Address (Low byte)
2	0x##	Bit Address (High byte)

		If there is a 0x10 included in address, and insert a 0x10 after it, the byte will move to next position. For example: 0x10, 0x04 will become 0x10,0x10,0x04
3	0x##	Sending byte (The byte has to be even, due to operating for word). If byte is 0x10 then insert a 0x10 after it, the byte will move to next position
4~4+n-1	0x##(L) 0x##(H) 0x##(L)...	The data of initial address for corresponding address for 1,2 byte, n is byte of data, if data includes 0x10 and then insert a 0x10, the sending byte number remains same, then n=n+1, and so on...
4+n , 4+n+1	0x10 , 0x03	End sign
4+n+2	0x##	checksum , Xor check-up and bytes in the front

Below is an example for observation process of communication. If Master has a 0x0a in MW3, according to this protocol, master will communicate with slave immediately, and slave will put the 0x0a in corresponding MW3, the procedure is as following:

Master sending STX(0x02h).

Slave receives STX(0x02h) from master, and sending ACK(0x06h) to master.

Master receives ACK(0x06h) from slave.

Master sending 0x01,0x03,0x00,0x02,0x0a,0x00,0x10,0x03,0x19, as shown below:

Offset(byte)	Format	Description
0	0x01	The operating sign for MW
1	0x03	Address(Low byte)
2	0x00	Bit Address (High byte)
3	0x02	Sending byte (The byte has to be even, due to MW3 is two byte).
4 , 5	0x0a , 0x00	MW3 content is 0x0a , 0x00
6 , 7	0x10 ,	End sign

	0x03	
8	0x19	checksum , $0x01 \wedge 0x03 \wedge 0x00 \wedge 0x02 \wedge 0x0a \wedge 0x00 \wedge 0x10 \wedge 0x03 = 0x19$

Slave received data from master and then sending ACK(0x06h).

Master receives ACK(0x06h) from slave.

When finishing communication, master sending revised data of MW to slave, and slave

changes the MW which corresponds to that of master. At this time, master and slave keep the same data in the same address.

Another example below, the address and data include 0x10; please notice the change in data format. Now, if we have 0x10 in MW16 in slave, according to this protocol, slave will communicate with master immediately, and master will put 0x10 in data of corresponding MW16, the procedure is as following:

Slave sending STX(0x02h)

Master receives STX(0x02h) from slave, and sending ACK(0x06h) to Slave.

Slave receives ACK(0x06h) from master

Slave sending data

0x01,0x10,0x10,0x00,0x02,0x10,0x10,0x00,0x10,0x03,0x10 as shown below:

Offset (byte)	Format	Description
0	0x01	The operating sign to MW
1	0x10	Address(Low byte)
2	0x10	Insert 0x10
3	0x00	Bit Address (High byte)
4	0x02	Sending byte (MW10 is two bytes)
5	0x10	0x10 is low byte in MW10
6	0x10	Insert 0x10
7	0x00	0x00 in high byte
8 , 9	0x10 , 0x03	End sign

10	0x10	checksum , 0x01^0x10^0x10^0x00^0x02^0x10^0x10^0x00^0x10^0x03=0x10
----	------	--

Master receives data from slave and sending ACK(0x06h) to slave.
Slave receives ACK(0x06h) from master.

When finishing communication, slave sending the address and content of MW to master, at this time, master changes data of MW corresponding to that of Slave, then master and slave keep the same data in the same address.

Below is an example for communication between two HMI via MemoryMap.
First of all, create a new project in EasyBuilder

Edit/System Parameter Setting/PLC

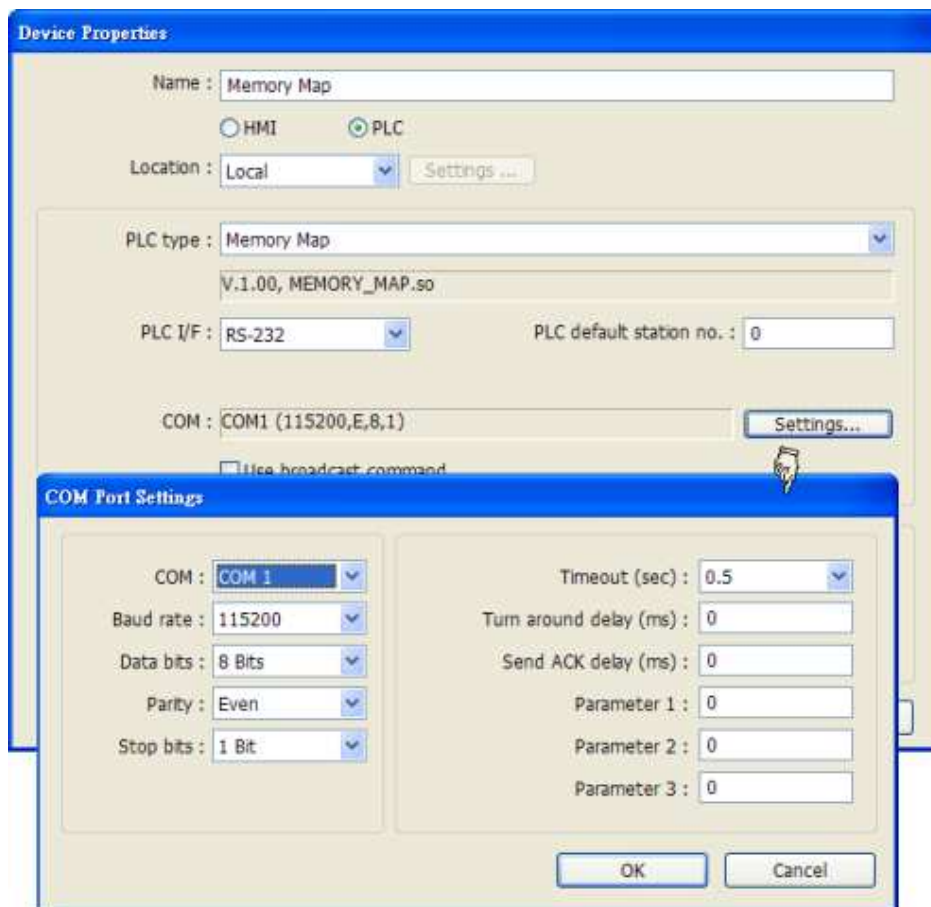

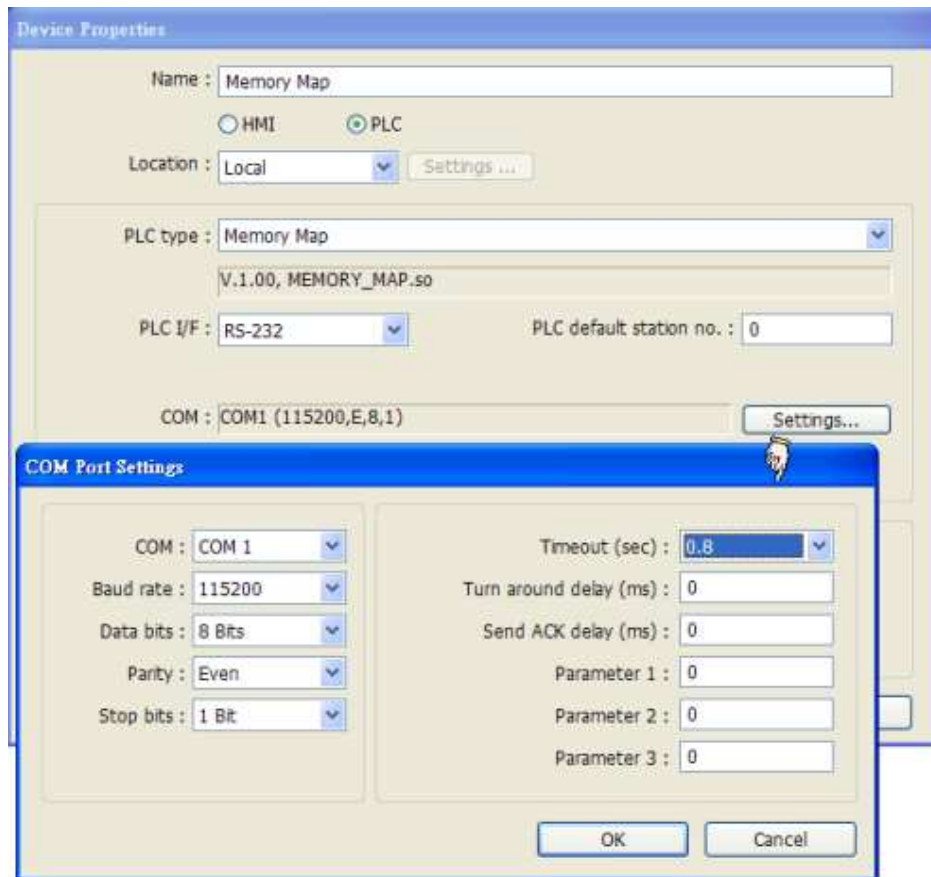

Note:

1. Between two HMI, Time out has to set to 0.5 sec. and another has to set to 0.8 sec.
2. [Data bit] has to be 8 bits.
3. The rest of the settings should be identical between two HMI.

Adding two objects on window10, a toggle switch setting is as illustration below:

New Toggle Switch Object

General Security Shape Label

Description :

Read address

PLC name : Memory Map

Address : MB Invert signal

Write address :

PLC name : Memory Map

Address : MB Write when button is released

Attribute

Switch style : Toggle

Macro

Execute macro

A multistate switch object setting is as following:

New Multi-State Switch Object

General Security Shape Label

Description :

Mode : Value Offset : 0

Read address

PLC name : Memory Map

Address : MW 0 16-bit Unsigned

Write address :

PLC name : Memory Map

Address : MW 0 16-bit Unsigned

Write when button is released

Attribute

Switch style : JOG+ No. of states : 3

Cyclical : Enable

User-defined mapping

[Save],[Compile],[Download]

Change parameter in [System Parameter Setting]/[PLC] and download to another HMI.

The HMI display is as following:

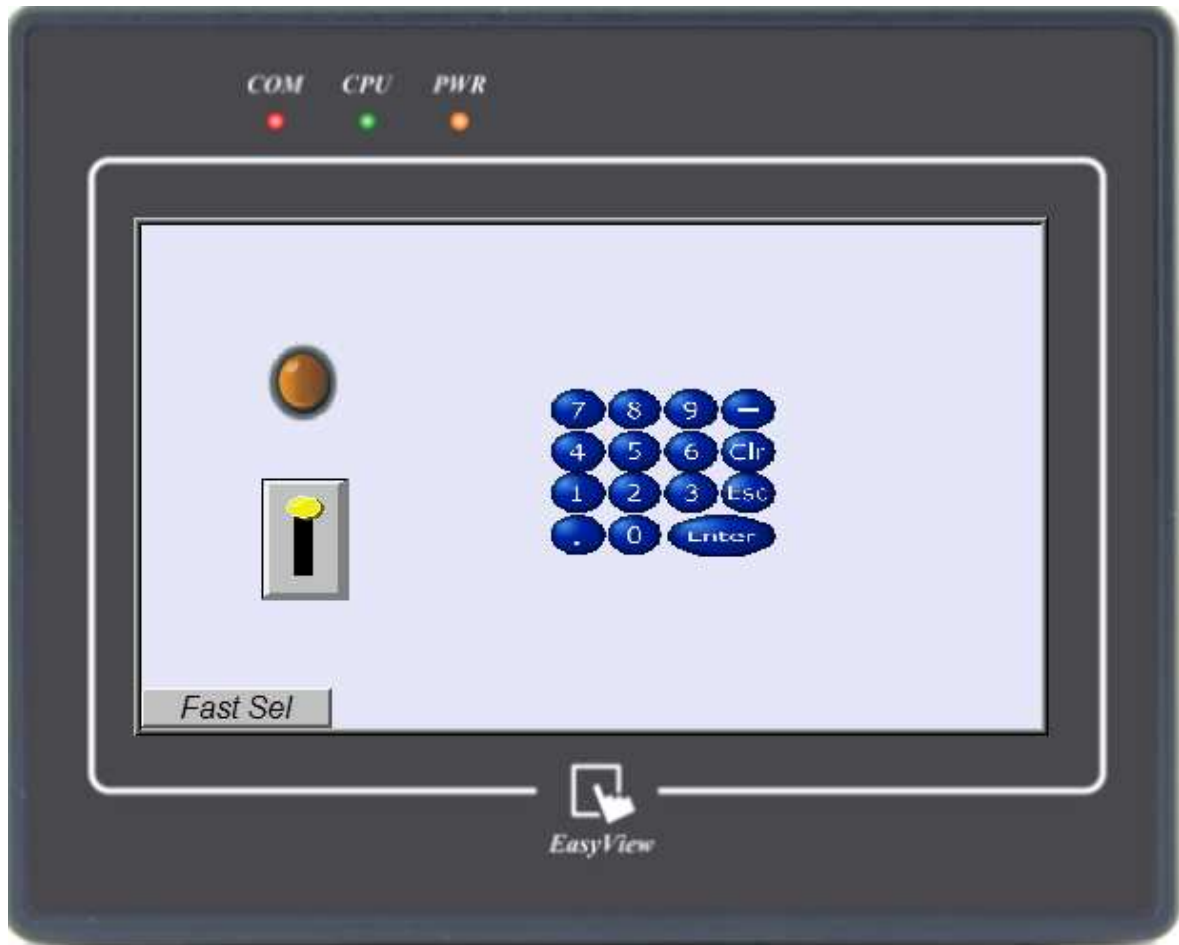

Users may try to touch the screen; the other HMI will act the same as current HMI.

The communicating way is the same as above-mentioned. The point is to keep the same data in the same register.

Chapter 32 FTP Server Application

In addition to backup history data from HMI to PC by SD card, USB memory stick or EasyPrinter, FTP Server can also be applied to do this. After downloading project to HMI, FTP Server can be used to backup history data and recipe data, and also to update recipe data. The files in FTP Server can't be deleted.

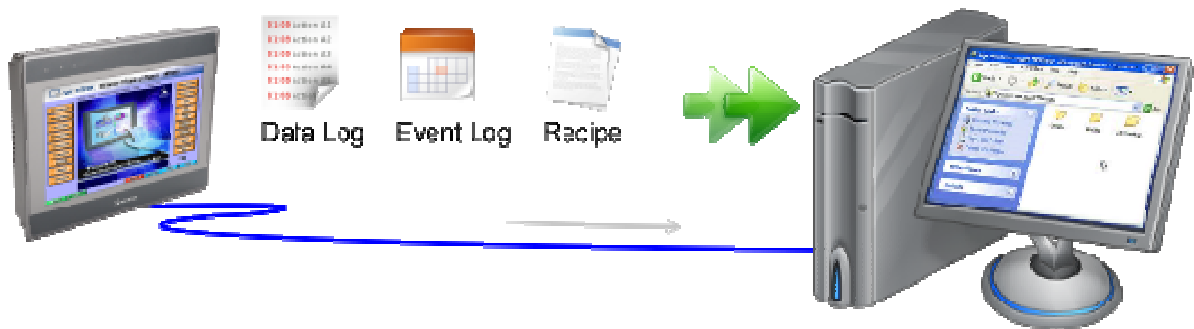

32.1 Login FTP Server

Step 1. Before login FTP Server, please check the OS Image version:

i Series: OS Image 20100818 or later.

X Series: OS Image 20100906 or later.



Step 2. Enter HMI IP: <ftp://192.168.1.117/> (example), login user name: uploadhis, and the HMI history upload password (if not changed, the default is 111111). Or, to directly enter <ftp://uploadhis:111111@192.168.1.117/>

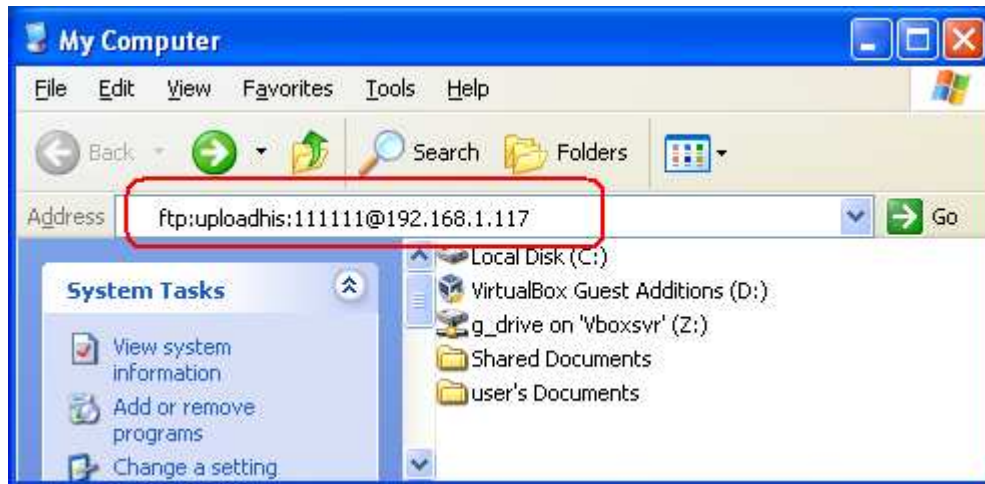

Step 3. After entering IP, <ftp://192.168.1.117/> is shown, and the “datalog”, “eventlog”, and “recipe” folders can be seen.

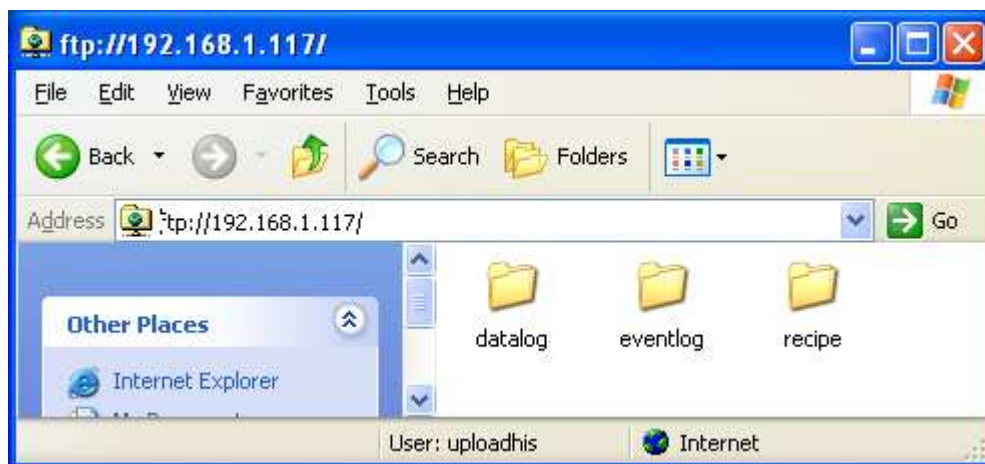

32.2 Backup History Data and Update Recipe Data

◆ To backup “Data

Sampling” records

1. Click “datalog” folder to check the file names set by EasyBuilder Pro.
2. Click on file names to check content.
3. Copy and paste to save files on PC.

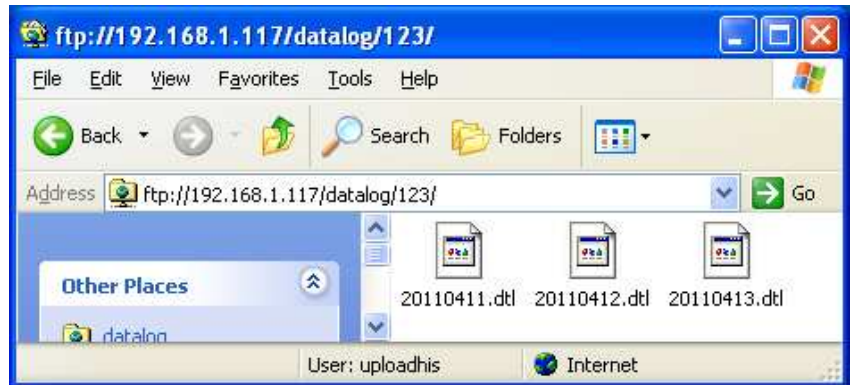

◆ To backup “Event

(Alarm) Log” records

1. Click “eventlog” folder to check the files.
2. Copy and paste to save files on PC.

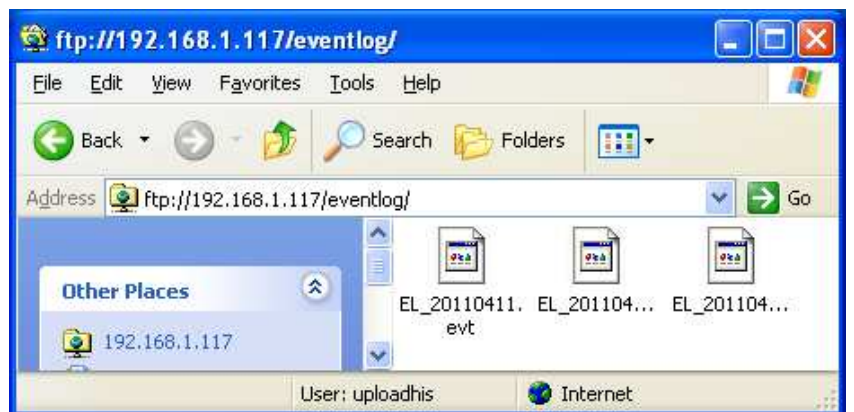

◆ To backup and update

“Recipe” records

1. Click “recipe” folder to check the files.
2. To update “recipe” data on HMI, overwrite “recipe.rcp” with new data and restart HMI in one minute.





■ Since recipe data is automatically saved once every minute, after updating “recipe.rcp” or “recipe_a.rcp”, HMI must be restarted in one minute otherwise the new updated recipe data will be overwritten by the former data. [LB-9047] and [LB-9048] can also be used to restart HMI. Set [LB-9048] to ON and then set [LB-9047] to ON to successfully restart HMI.

System Registers:

[LB-9047] reboot HMI (set ON when LB9048 is ON)

[LB-9048] reboot-HMI protection

Chapter 33 EasyDiagnoser

33.1 Overview and Configuration

Overview

EasyDiagnoser is a tool for detecting the error occurs while HMI is communicating with PLC.

Configuration

Step 1.

Open Project Manager and click EasyDiagnoser.

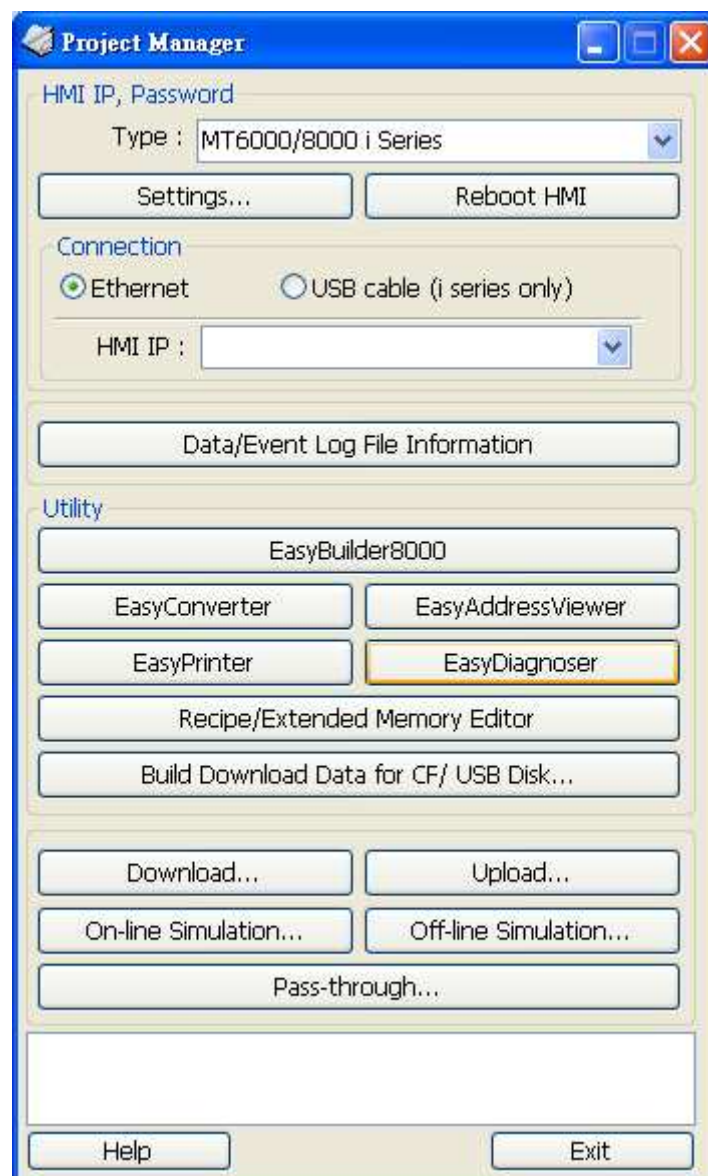

Step 2.

Set the IP address of the HMI to communicate with.

Users can input IP address manually or simply click [Search All]. Please input Project Port as well.

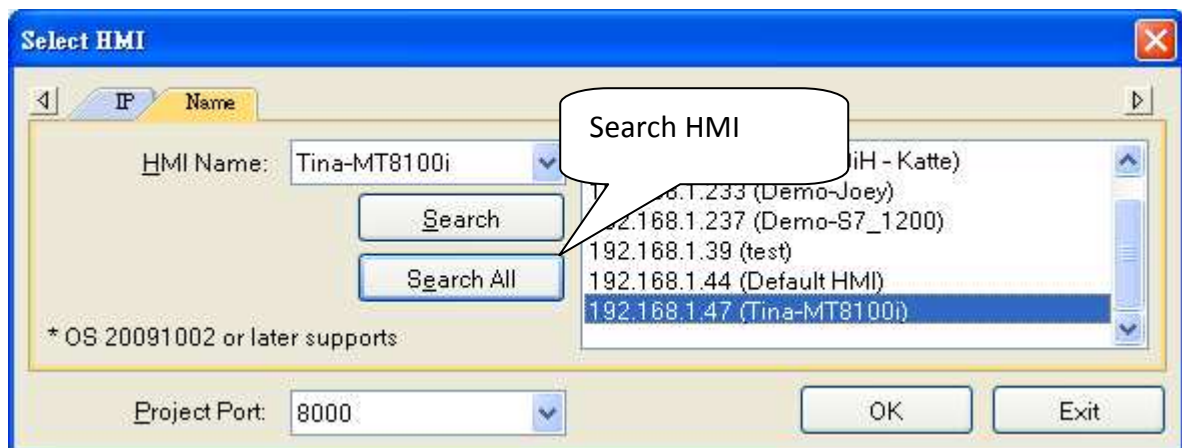
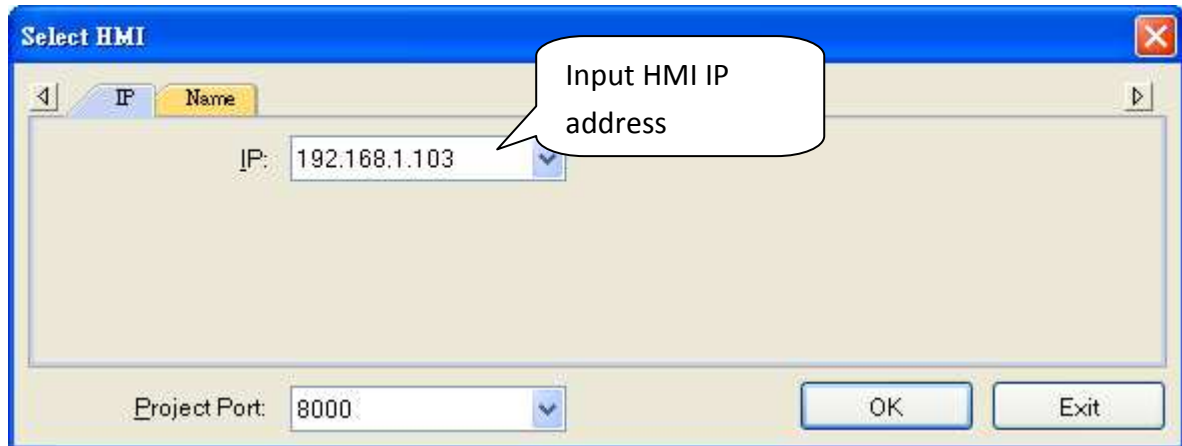

It is also available to right click and select "Run EasyDiagnoser" for entering the setting window when executing On-Line Simulation in EB8000.

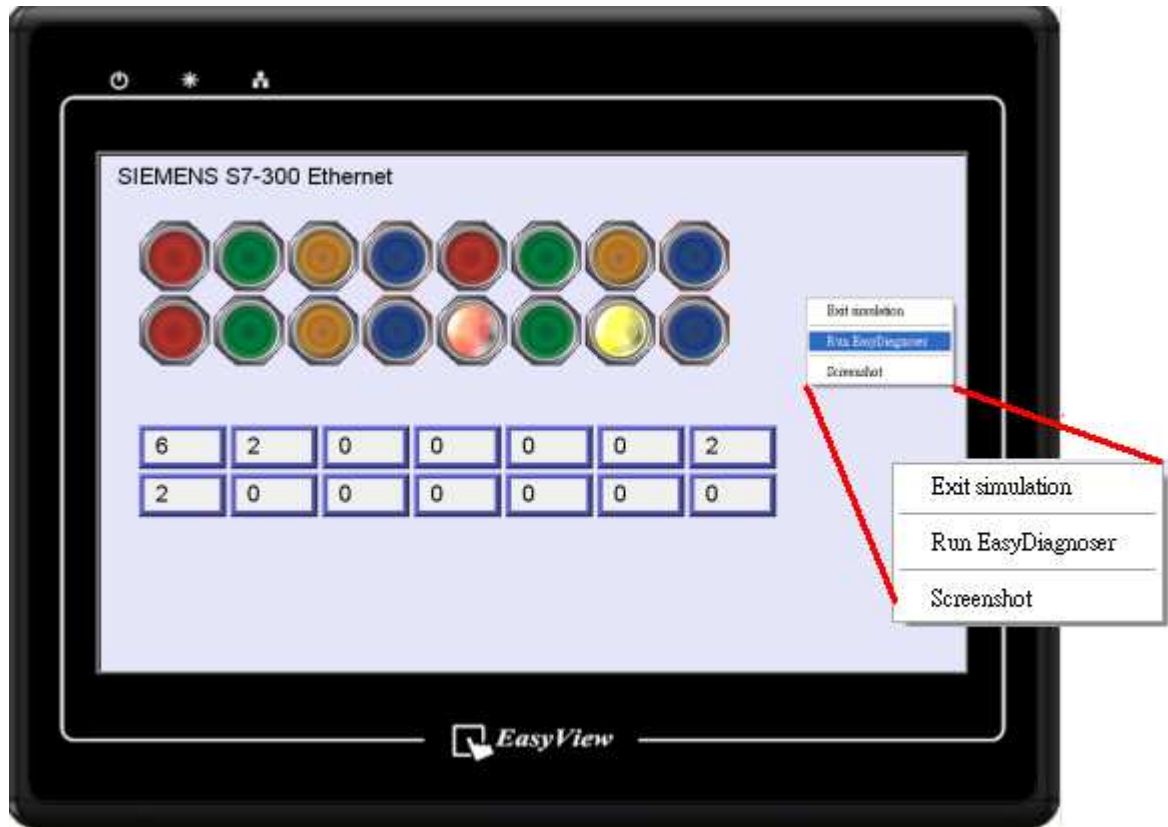

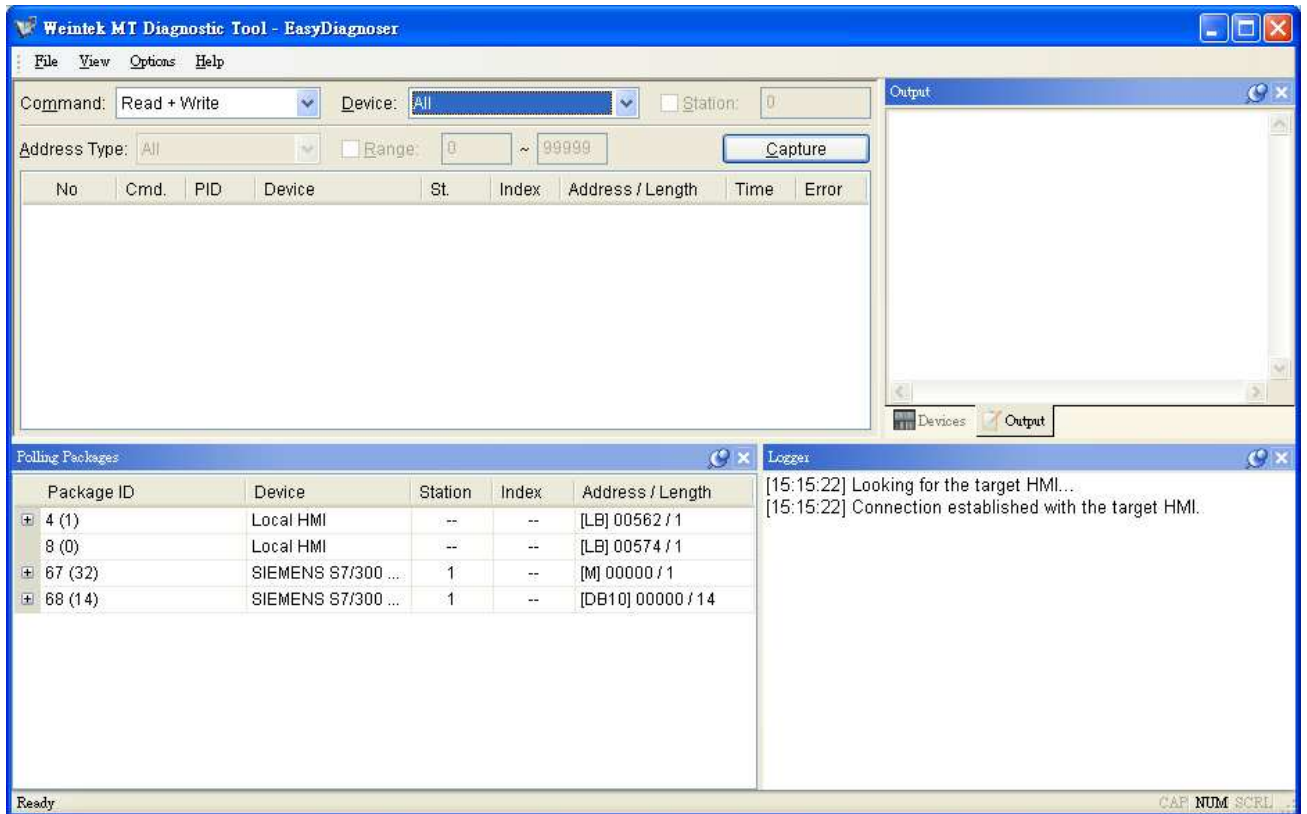

After setting completed, click OK, EasyDiagnoser operation window appears as below:



33.2 EasyDiagnoser Settings

Item	Description																
File	<p>Save As</p> <p>The captured information of Easy Diagnoser can be saved as *.xls which can be read in Excel.</p> 																
	<p>Exit</p> <p>Exit current file.</p>																
View	<table border="0"> <tr> <td></td> <td><u>D</u>evice Bar</td> <td>Ctrl+Alt+D</td> <td>Click [Device Bar] to display Device window.</td> </tr> <tr> <td></td> <td><u>P</u>ackage Bar</td> <td>Ctrl+Alt+P</td> <td>Click [Package Bar] to display Package window.</td> </tr> <tr> <td></td> <td><u>L</u>ogger Bar</td> <td>Ctrl+Alt+L</td> <td>Click [Logger Bar] to display Logger window.</td> </tr> <tr> <td></td> <td><u>O</u>utput Bar</td> <td>Ctrl+Alt+O</td> <td>Click [Output Bar] to display Output window.</td> </tr> </table>		<u>D</u> evice Bar	Ctrl+Alt+D	Click [Device Bar] to display Device window.		<u>P</u> ackage Bar	Ctrl+Alt+P	Click [Package Bar] to display Package window.		<u>L</u> ogger Bar	Ctrl+Alt+L	Click [Logger Bar] to display Logger window.		<u>O</u> utput Bar	Ctrl+Alt+O	Click [Output Bar] to display Output window.
	<u>D</u> evice Bar	Ctrl+Alt+D	Click [Device Bar] to display Device window.														
	<u>P</u> ackage Bar	Ctrl+Alt+P	Click [Package Bar] to display Package window.														
	<u>L</u> ogger Bar	Ctrl+Alt+L	Click [Logger Bar] to display Logger window.														
	<u>O</u> utput Bar	Ctrl+Alt+O	Click [Output Bar] to display Output window.														

<p>Options</p> <p>Options Help</p> <p>Toolbars</p> <p><input checked="" type="checkbox"/> Status Bar</p> <p>Update Package List F5</p> <p>Show Object ID (HMI)</p> <p>Clear Activity List</p>	<p>Toolbars</p> <p>Display toolbar icons of [Device Bar] [Package Bar] [Logger Bar] [Output Bar].</p>  <p>Show Status Bar</p> <p>At the bottom of EasyDiagnoser window, display information of CAP, NUM, and SCRL.</p>  <p>Update Package List</p> <p>When users change window in HMI, update the Polling Package information of current window with this list.</p> <p>Show Object ID (HMI)</p> <p>Show the ID of objects in HMI as shown below.</p>  <p>Clear Activity List</p> <p>Clear all information in activity area.</p>  <table border="1" data-bbox="598 1646 1361 1848"> <thead> <tr> <th>No</th> <th>Cmd.</th> <th>PID</th> <th>Device</th> <th>st.</th> <th>In</th> </tr> </thead> <tbody> <tr> <td>139</td> <td>R</td> <td>68</td> <td>SIEMENS S7/300 Et...</td> <td>1</td> <td></td> </tr> <tr> <td>138</td> <td>R</td> <td>4</td> <td>Local HMI</td> <td>--</td> <td></td> </tr> <tr> <td>137</td> <td>R</td> <td>8</td> <td>Local HMI</td> <td>--</td> <td></td> </tr> <tr> <td>136</td> <td>R</td> <td>67</td> <td>SIEMENS S7/300 Et...</td> <td>1</td> <td></td> </tr> </tbody> </table>	No	Cmd.	PID	Device	st.	In	139	R	68	SIEMENS S7/300 Et...	1		138	R	4	Local HMI	--		137	R	8	Local HMI	--		136	R	67	SIEMENS S7/300 Et...	1	
No	Cmd.	PID	Device	st.	In																										
139	R	68	SIEMENS S7/300 Et...	1																											
138	R	4	Local HMI	--																											
137	R	8	Local HMI	--																											
136	R	67	SIEMENS S7/300 Et...	1																											
<p>Help</p>	<p>Display EasyDiagnoser version information.</p>																														



- **Activity area**

In the activity area, users can observe the communication between HMI and PLC.

No	Cmd.	PID	Device	St.	Index	Address / Length	Time	Error
▶ 139	R	68	SIEMENS S7/300 ...	1	255	[DB10] 00000 / 14	50	0
138	R	4	Local HMI	--	--	[LB] 00562 / 1	20	0
137	R	8	Local HMI	--	--	[LB] 00574 / 1	10	0
136	R	67	SIEMENS S7/300 ...	1	255	[M] 00000 / 1	40	0
135	R	4	Local HMI	--	--	[LB] 00562 / 1	20	0
134	R	8	Local HMI	--	--	[LB] 00574 / 1	20	0
133	R	68	SIEMENS S7/300 ...	1	255	[DB10] 00000 / 14	30	0
132	R	4	Local HMI	--	--	[LB] 00562 / 1	20	0
131	R	8	Local HMI	--	--	[LB] 00574 / 1	20	0
130	R	67	SIEMENS S7/300 ...	1	255	[M] 00000 / 1	40	0
129	R	4	Local HMI	--	--	[LB] 00562 / 1	20	0

Item	Description
Command	a. Read + Write Display Read and Write commands in activity area.
	b. Read Display only Read commands in activity area.
	c. Write Display only Write commands in activity area.
Device	a. All Display information of Local HMI and PLC. It depends on the setting of command as following. <ul style="list-style-type: none"> ● If command is set Read + Write, the Read and Write information of Local HMI and PLC will be displayed in activity

	<p>area.</p> <ul style="list-style-type: none"> • If command is set Read, the Read information of Local HMI and PLC will be displayed in activity area. • If command is set Write, the Write information of Local HMI and PLC will be displayed in activity area.
	<p>b. Local HMI</p> <p>Display information of Local HMI, it depends on the setting of command as following.</p> <ul style="list-style-type: none"> • If command is set Read + Write, the Read and Write information of Local HMI will be displayed in activity area. • If command is set Read, the Read information of Local HMI will be displayed in activity area. • If command is set Write, the Write information of Local HMI will be displayed in activity area.
	<p>c. PLC</p> <p>Display information of PLC, it depends on the setting of command as following.</p> <ul style="list-style-type: none"> • If command is set Read + Write, the Read and Write information of PLC will be displayed in activity area. • If command is set Read, the Read information of PLC will be displayed in activity area. • If command is set Write, the Write information of PLC will be displayed in activity area.
Station	Select specific Station for display on the screen. (This function will be disabled when selecting [All] in Device).
Address Type	Users can select all or a part of address types to be displayed on the screen. (This function will be disabled when selecting [All] in Device).
Range	Set the range of address types to be displayed. (This function will be disabled when selecting [All] in Address Type).
Capture	Click to start/stop capturing communication message.
Error	Please refer to the section coming later.

- **Polling Packages**

Package ID	Device	Station	Index	Address / Length
4 (1)	Local HMI	--	--	[LB] 00562 / 1
8 (0)	Local HMI	--	--	[LB] 00574 / 1
67 (32)	SIEMENS S7/300 Ethernet	1	--	[M] 00000 / 1
68 (3)	SIEMENS S7/300 Ethernet	1	10	[DB10] 00000 / 3
69 (3)	SIEMENS S7/300 Ethernet	1	11	[DB10] 00003 / 3
70 (3)	SIEMENS S7/300 Ethernet	1	12	[DB10] 00006 / 3
71 (5)	SIEMENS S7/300 Ethernet	1	--	[DB10] 00009 / 5

Item	Description
Package ID	Use the information of package ID to check the PID in activity area for finding the problem.
Device	Displays HMI and PLC type.
Station	Displays PLC station number.
Index	Display objects-used index register numbers.
Address/Length	Displays device type address. Length-how many words of the Package.

Object	Device	Screen	ID	Address
4 (1)	Local HMI	--	--	[LB] 00562 / 1
8 (0)	Local HMI	--	--	[LB] 00574 / 1
67 (32)	SIEMENS S7/300 Ethernet	1	--	[M] 00000 / 1
▶ Toggle S...		10	30	[M] 00000
Toggle S...		10	30	[M] 00000
Toggle S...		10	29	[M] 00000
Toggle S...		10	29	[M] 00000
Toggle S...		10	28	[M] 00000
Toggle S...		10	28	[M] 00000
Toggle S...		10	27	[M] 00000

After opening Package, the information such as Object, Screen, ID, Address inside it will be displayed.

Object	Package ID where this object is placed.
Screen	Window in the project where this object is placed.
ID	ID of the object.
Address	Address of the object.

Note:

- a. Click [**Package ID**], the device station number will be displayed in 3rd column.

Package ID	Device	Station	Index	Address / Length
4 (1)	Local HMI	--	--	[LB] 00562 / 1
8 (0)	Local HMI	--	--	[LB] 00574 / 1
67 (32)	SIEMENS S7/300 Ethernet	1	--	[M] 00000 / 1
68 (3)	SIEMENS S7/300 Ethernet	1	10	[DB10] 00000 / 3

b. Double click **[Package ID]** then select **[object]**, the 1st column directs the object's position.

For example, select [Numeric Input] and the screen no. displays 10.

This shows that this object is in window no. 10 in the project and will be marked with pink frame in HMI as shown below.

Object	Device	Screen	ID	Address
4 (1)	Local HMI	--	--	[LB] 00562 / 1
8 (0)	Local HMI	--	--	[LB] 00574 / 1
67 (32)	SIEMENS S7/300 Ethernet	1	--	[M] 00000 / 1
68 (3)	SIEMENS S7/300 Ethernet	1	10	[DB10] 00000 / 3
▶ Numeric I...		10	2	[DB10] 00000
Numeric I...		10	3	[DB10] 00001
Numeric I...		10	4	[DB10] 00002

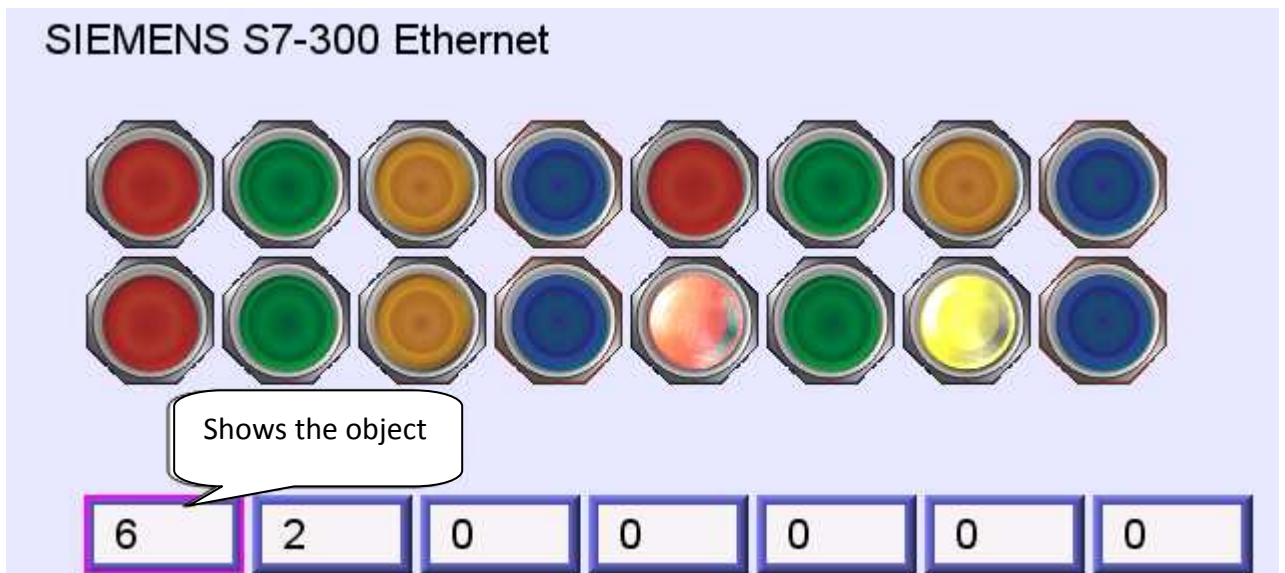

- **Devices**

Devices window displays information of HMI and PLC.

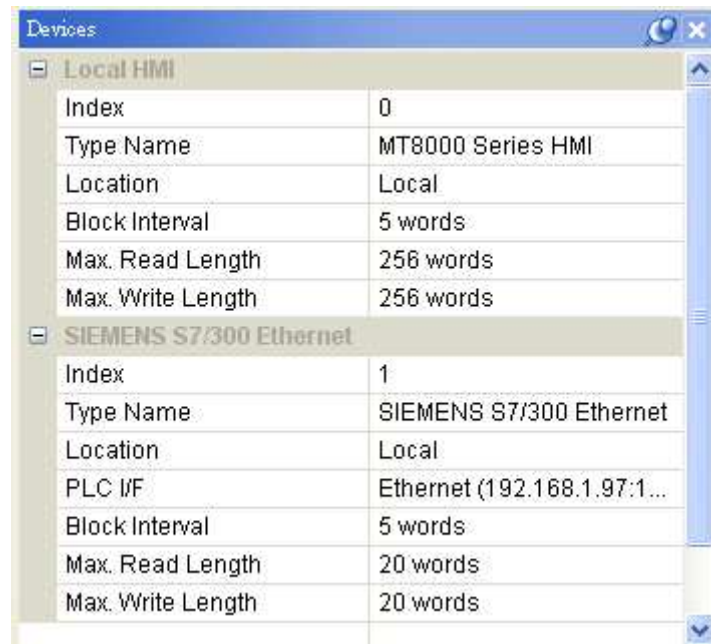

Local HMI	
Index	0
Type Name	MT8000 Series HMI
Location	Local
Block Interval	5 words
Max. Read Length	256 words
Max. Write Length	256 words

SIEMENS S7/300 Ethernet	
Index	1
Type Name	SIEMENS S7/300 Ethernet
Location	Local
PLC I/F	Ethernet (192.168.1.97:1...
Block Interval	5 words
Max. Read Length	20 words
Max. Write Length	20 words

- **Output (Macro debug)**

With Trace function offered by Macro, the executing status of Macro can be seen. Please refer to EB8000 user's manual "*Chapter 18 MACRO*" for more information.

In illustration below, for [ID 2, Ln 7] and [ID 2, Ln 8]

ID 2 represents Macro name.

Ln 7 and Ln 8 represent that they are in 7th and 8th lines of Macro.



33.3 Error Code

In activity area, users can find the reason of error through error codes listed below.

- 0: Normal
- 1: Time out
- 2: Fail Error
- 12: Ignore

When error occurs, error message will be shaded red as shown below.

The error code is 1 since PLC is disconnected with HMI.

The error code is 12 since “PLC No Response” message window is shown.

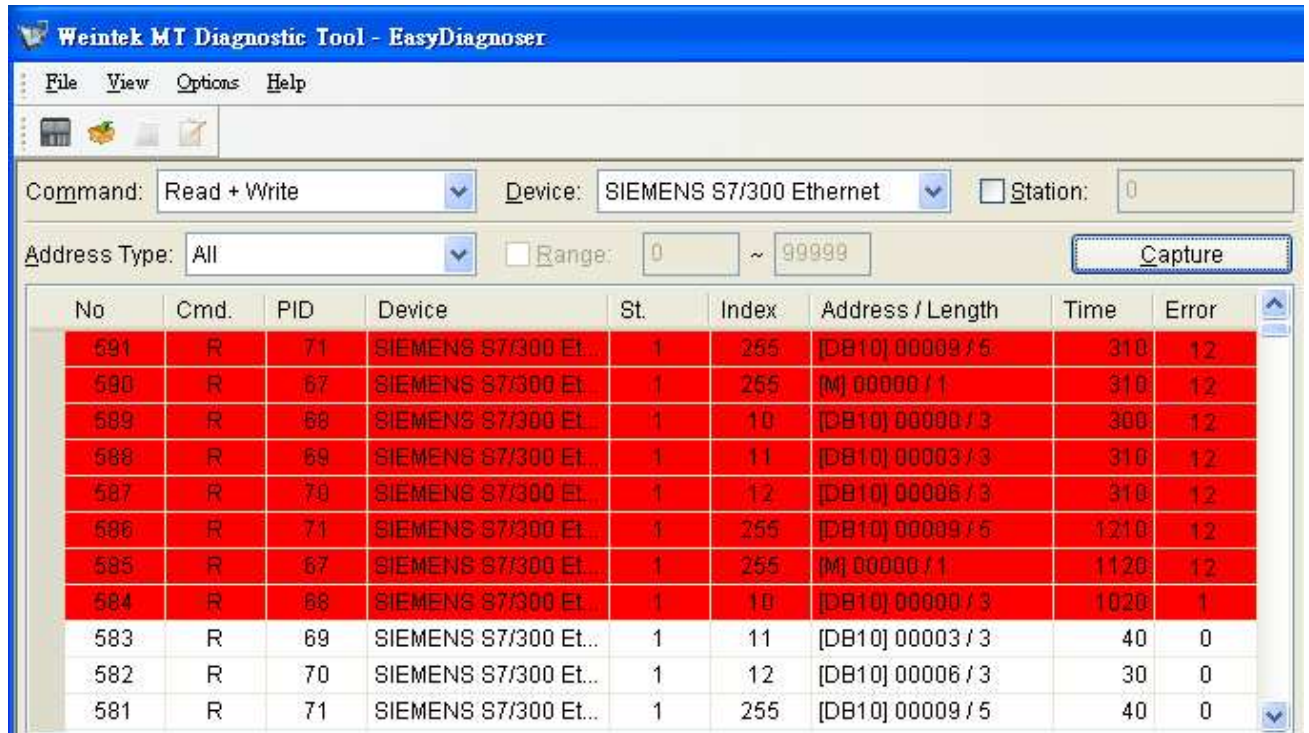

The screenshot shows the 'Weintek MT Diagnostic Tool - EasyDiagnoser' interface. The 'Command' is set to 'Read + Write', 'Device' is 'SIEMENS S7/300 Ethernet', and 'Station' is '0'. The 'Address Type' is 'All' and the 'Range' is '0 ~ 99999'. A 'Capture' button is visible. The main data table is as follows:

No	Cmd.	PID	Device	St.	Index	Address / Length	Time	Error
591	R	71	SIEMENS S7/300 Et...	1	255	[DB10] 00009 / 5	310	12
590	R	67	SIEMENS S7/300 Et...	1	255	[M] 00000 / 1	310	12
589	R	68	SIEMENS S7/300 Et...	1	10	[DB10] 00000 / 3	300	12
588	R	69	SIEMENS S7/300 Et...	1	11	[DB10] 00003 / 3	310	12
587	R	70	SIEMENS S7/300 Et...	1	12	[DB10] 00006 / 3	310	12
586	R	71	SIEMENS S7/300 Et...	1	255	[DB10] 00009 / 5	1210	12
585	R	67	SIEMENS S7/300 Et...	1	255	[M] 00000 / 1	1120	12
584	R	68	SIEMENS S7/300 Et...	1	10	[DB10] 00000 / 3	1020	1
583	R	69	SIEMENS S7/300 Et...	1	11	[DB10] 00003 / 3	40	0
582	R	70	SIEMENS S7/300 Et...	1	12	[DB10] 00006 / 3	30	0
581	R	71	SIEMENS S7/300 Et...	1	255	[DB10] 00009 / 5	40	0

33.4 Save As

The captured information of Easy Diagnoser can be saved as *.xls which can be read in Excel.

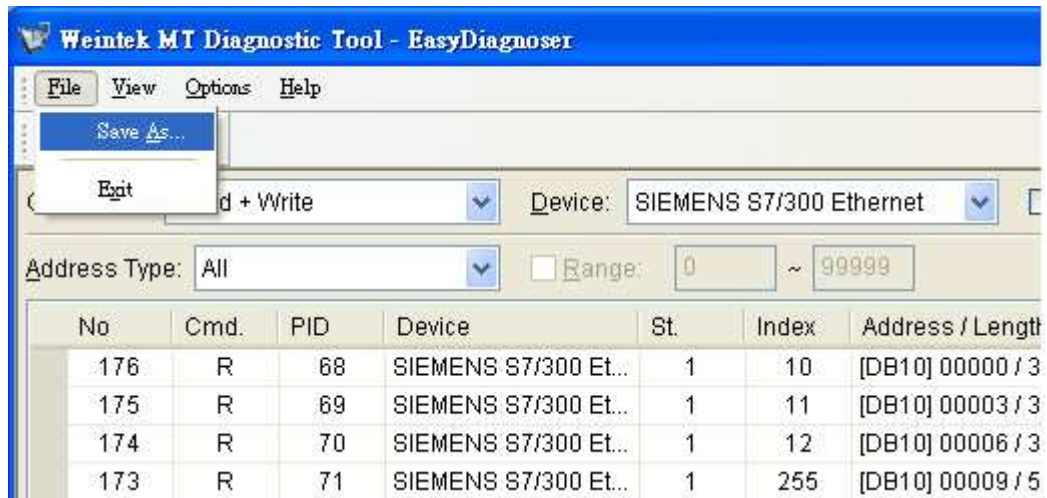

33.5 Window Adjustment

Users can drag or use smart docking icons in editing window to place the windows to the desired position.

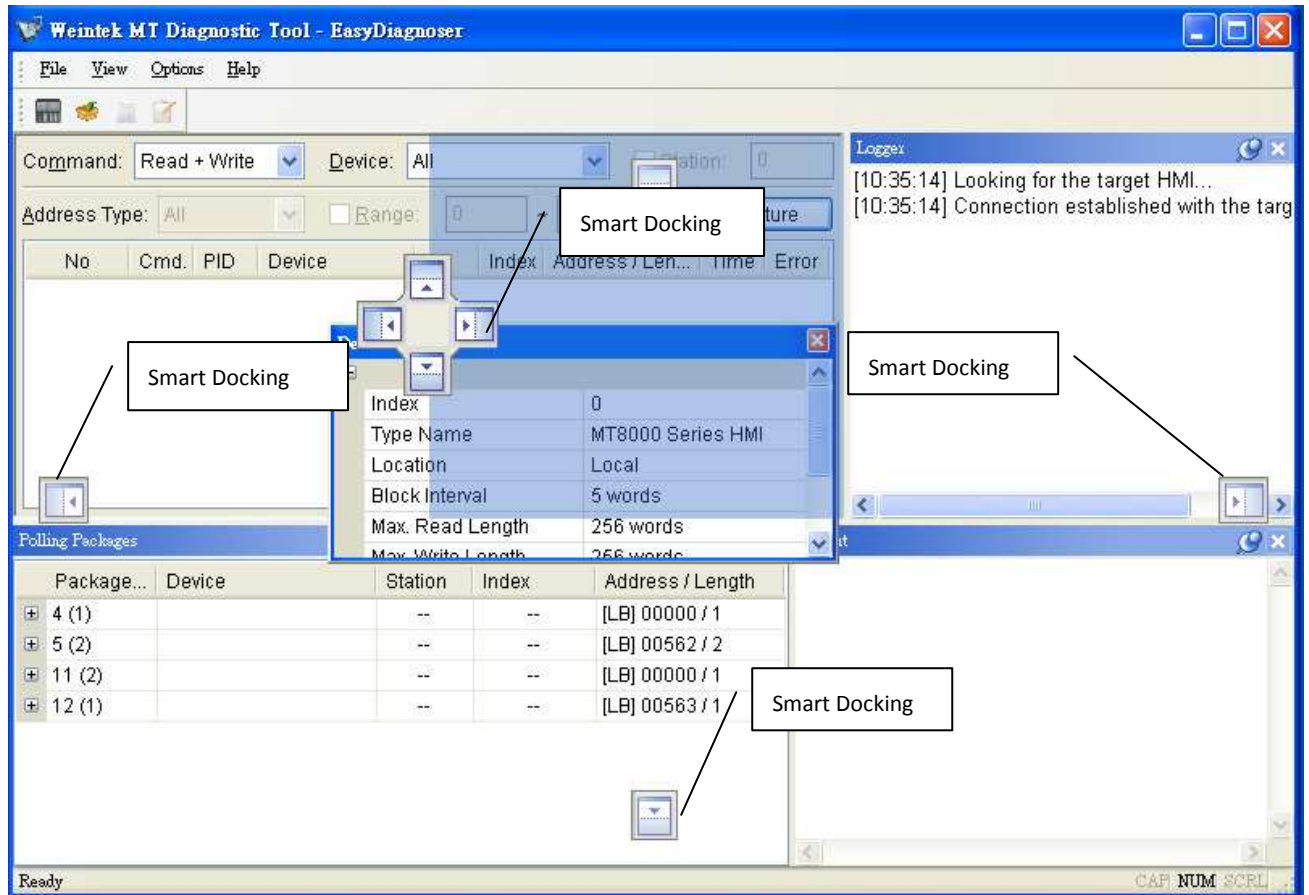

Note:

EasyDiagnoser doesn't support Siemens S7/1200 (Ethernet) and Allen-Bradley Ethernet/IP (CompactLogix/ControlLogix) – Free Tag Names since both of the PLC use tag.

Chapter 34 AB EtherNet/IP Free Tag Names

When using the driver of Allen-Bradley EtherNet/IP-Tag (CompactLogix/ControlLogix) in EB8000, users can import User-Defined Tag from CSV file of RSLogix5000. However, data type of User-Defined, Predefined and Module-Defined Structure won't be imported.

	A	B	C	D	E	F	
7	TYPE	SCOPE	NAME	DESCRIPT	DATATYPE	SPECIFIER	ATTRIBUTES
8	TAG		Local:1:C		AB:Embedded_IQ16F:C:0		
9	TAG		Local:1:I		AB:Embedded_IQ16F:I:0		
10	TAG		Local:2:C		AB:Embedded_OB16:C:0		
11	TAG		Local:2:I		AB:Embedded_OB16:I:0		
12	TAG		Local:2:O		AB:Embedded_OB16:O:0		
13	TAG		Array2D		DINT[25,5]		(RADIX := Decimal, Cons
14	TAG		ArrayBool		BOOL[256]		(RADIX := Decimal, Cons
15	TAG		ArrayDINT		DINT[130]		(RADIX := Decimal, Cons
16	TAG		ArrayReal		REAL[125]		(RADIX := Float, Constant
17	TAG		B001		INT[15]		(RADIX := Decimal, PLC
18	TAG		b003		INT[255]		(RADIX := Decimal, PLC
19	TAG		b1		BOOL		(RADIX := Decimal, Cons

Therefore, AB Data Type Editor in EB8000 is for users to import and edit User-Defined, Predefined and Module-Defined Structure.

34.1 Import User-Defined AB Tag to EB8000

Step 1. Create Tags from RSLogix5000.

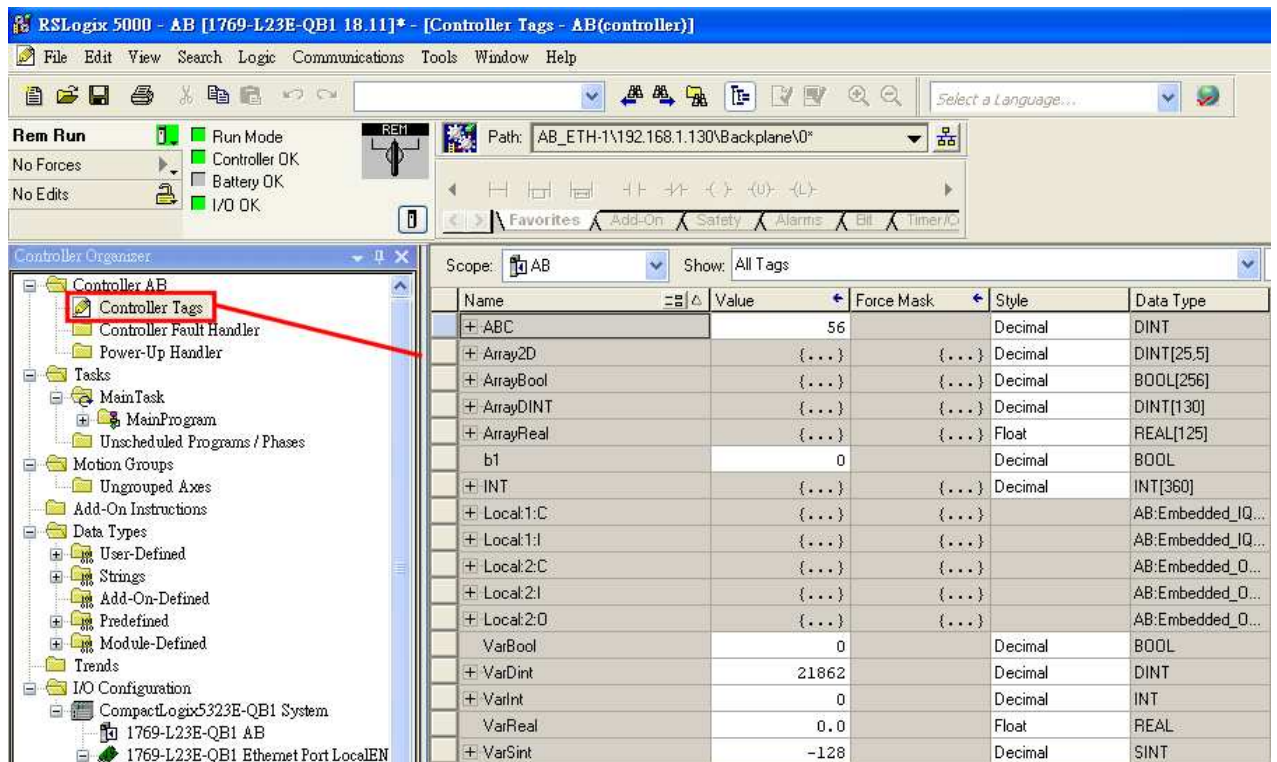

Step 2. Export Tags data to CSV file.

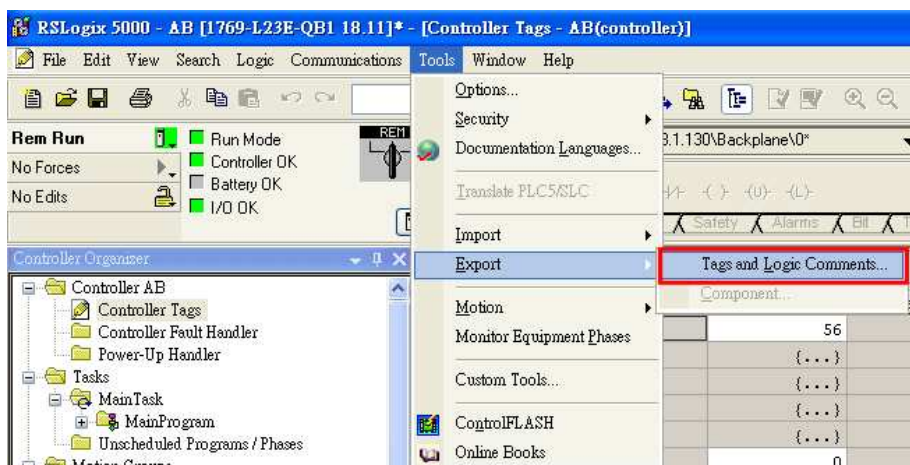

Step 3. In EB8000, create Allen-Bradley EtherNet/IP-Tag (CompactLogix/ControlLogix) driver.

Input PLC IP address. In System Parameter Settings dialog click [Import Tag...] button.

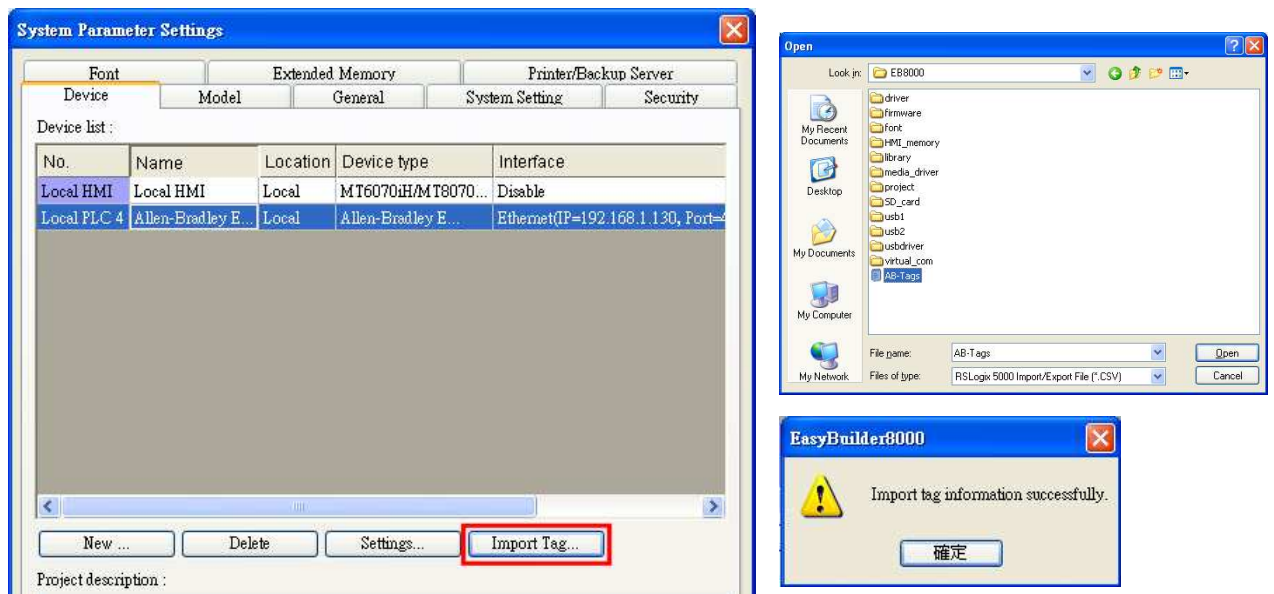

Step 4. In object dialog, select PLC, click Tag and select a controller tag.

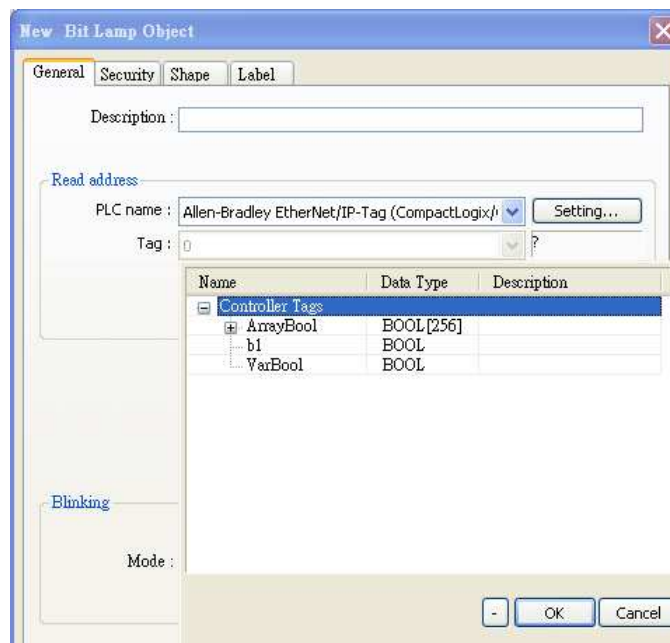

34.2 Adding New Data Type

Step 1. Right click on the assigned data type (usually labeled as [User-Defined]), then click [New Data Type] to start editing.

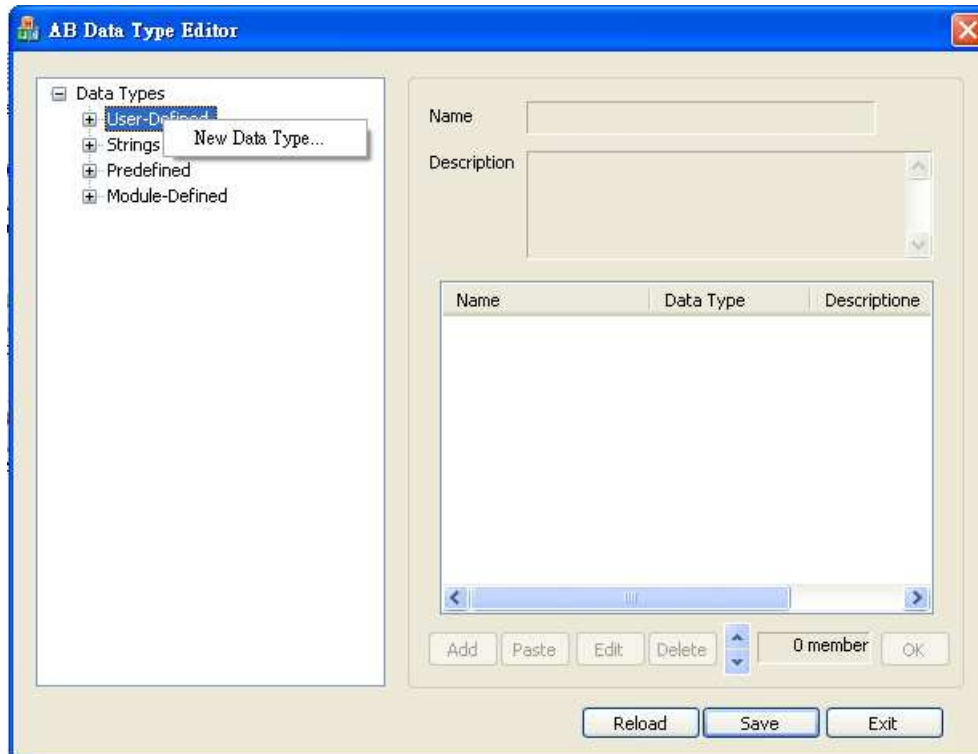

Step 2. Input the [Name] of the data type. [Description] can be skipped. For adding data member, click [Add].

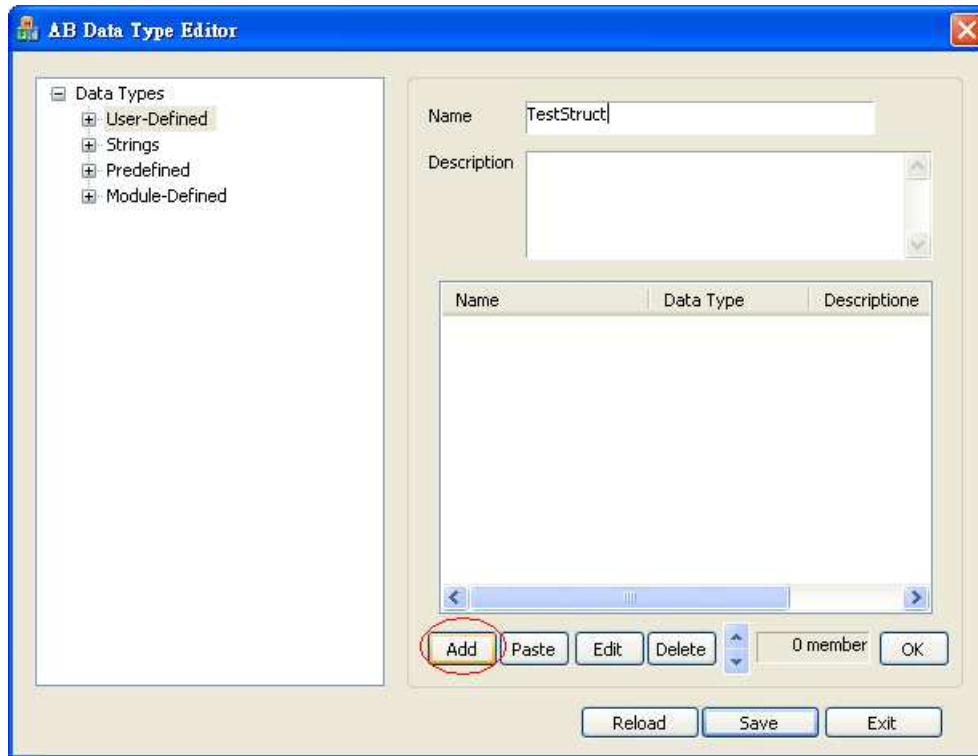

Step 3. Input in [Name] and [Data Type] then click [OK] to leave.

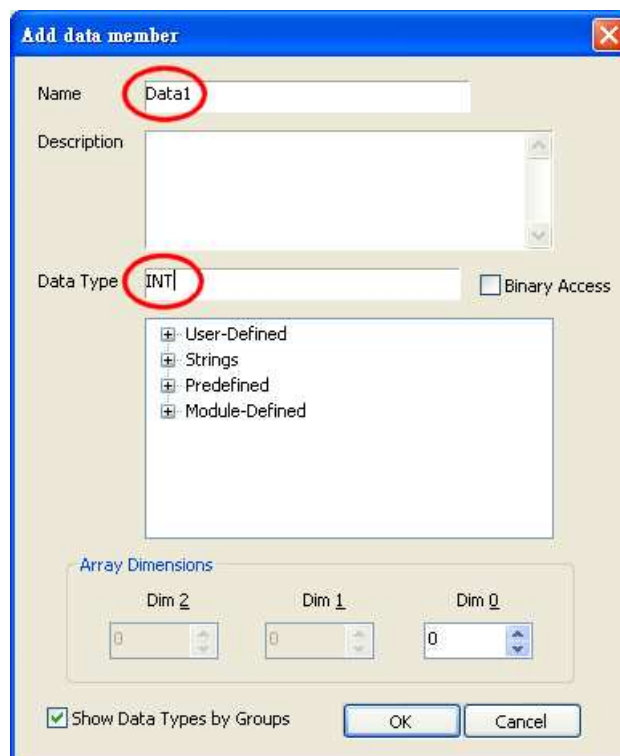

Step 4. After adding all data members, click [OK]. The built data type will be listed on the left side.

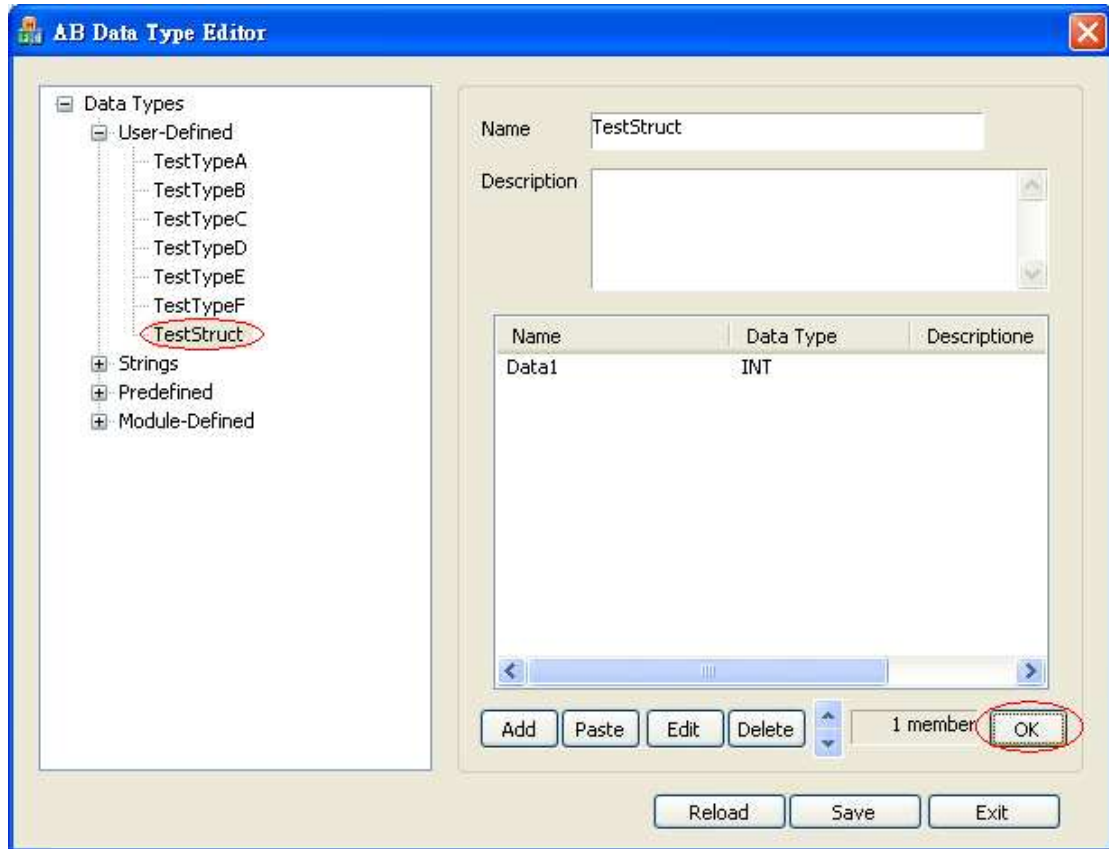

Note: After changing [Name] or [Description] of a data type, [OK] must be clicked to activate revision.

34.3 Paste

Step 1. When adding new data members, this function allows users to add multiple data at one time. The way is to click [Paste] in the [AB Data Type Editor] window.

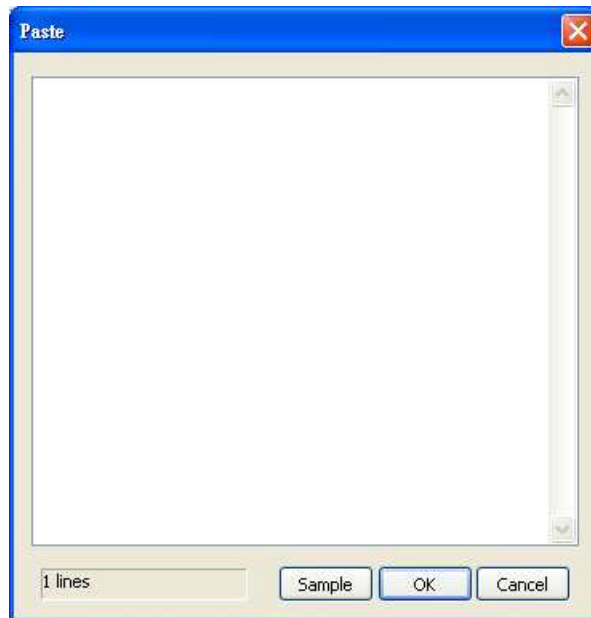

Step 2. The way to edit is to input data name in each line first, then use space or tab key to leave a space in each line. And then input data type or click [Sample] to see some reference. It is recommended to directly copy and paste from RSLogix5000 to avoid errors.

Name:

Description:

Members: Data Type Size: 60 byte(s)

	Name	Data Type	Style	Description	External Access
<input checked="" type="checkbox"/>	VarBool	BOOL	Decimal		Read/Write
<input type="checkbox"/>	BoolArray	BOOL[32]	Decimal		Read/Write
<input type="checkbox"/>	VarReal	REAL	Float		Read/Write
<input type="checkbox"/>	RealArray	REAL[5]	Float		Read/Write
<input type="checkbox"/>	VarInt	INT	Decimal		Read/Write
<input type="checkbox"/>	IntArray	INT[3]	Decimal		Read/Write
<input type="checkbox"/>	VarDint	DINT	Decimal		Read/Write
<input type="checkbox"/>	DintArray	DINT[3]	Decimal		Read/Write
<input type="checkbox"/>					

Step 3. The table above shows the defined data types in RSLogix. Select [Name] and [Data Type] with mouse. This can be done by pressing and holding on the first option, then slide down to the bottom until the scroll rolls to the end then stop holding. All the items will then be selected. Press ctrl+v to copy then paste to the editing window.

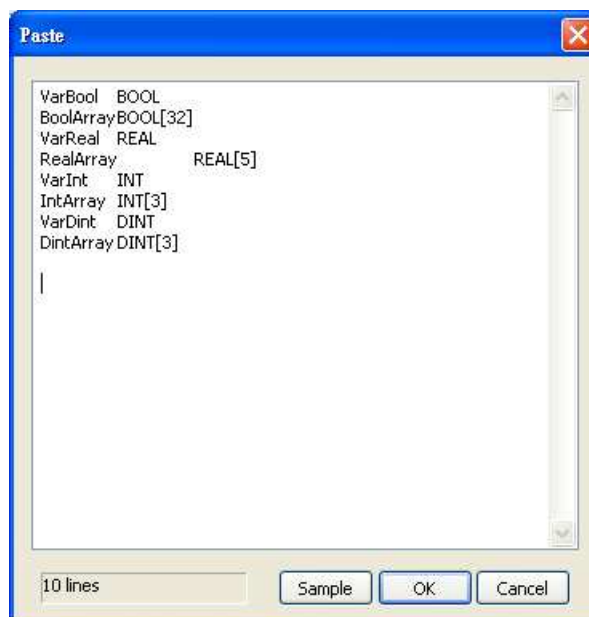

Step 4. At this moment press [OK] to finish operating then return to the main window to view the successfully added multiple data.

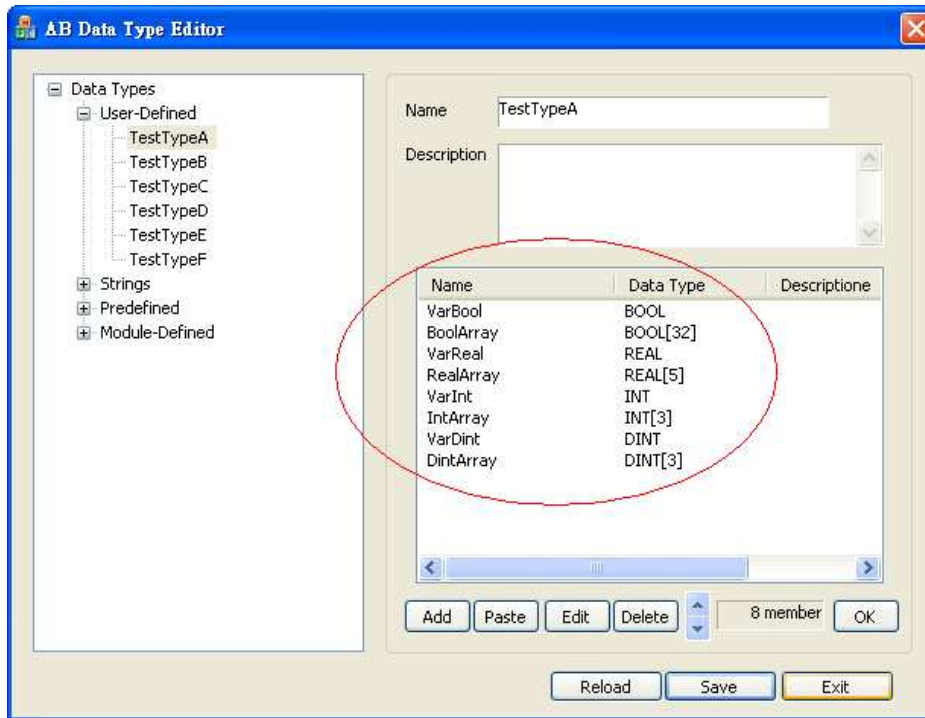

34.4 Miscellaneous

- Revising member data:

Directly double click on the data member to be revised in the main window, or click on the data member then press [Edit].

- Deleting data member:

Select the data to be deleted then click [Delete]. For deleting all data members, press and hold [Delete] button on the keyboard then click the [Delete] button in the main editing window.

- Adjusting the order of data members:

After selecting a single data member, use the move up and move down buttons in main window to adjust the order. This makes selecting items in EB8000 easier.

- Deleting data type:

In the list on the left side of the main window, select the data type to be deleted then press [Delete] on the keyboard. A confirming window pops up; click [Yes] to start deleting.

- Saving the result of revision:

After revising, [Save] button in main window must be clicked. Restart EB8000, the result of revision can be viewed.

- To Re-edit:

For giving up all revision done and to re-edit, click [Reload] button in main window.

34.5 Module-Defined

Here is an example showing how to define a default structure for a module. In **I/O Configuration** of RSLogix contains setting of I/O module.

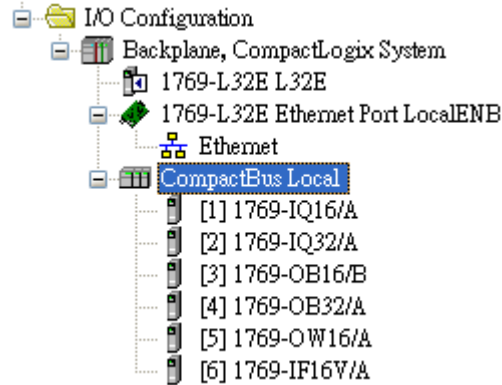

The Tags of these modules won't list the structure when exported to CSV file. Therefore, users should build it first.

	A	B	C	D	E	F	G	H
7	TYPE	SCOPE	NAME	DESCRIPT	DATATYPE	SPECIFIER	ATTRIBUTES	
8	TAG		Local:1:I		AB:1769_DI16:I:0			
9	TAG		Local:2:I		AB:1769_DI32:I:0			
10	TAG		Local:3:C		AB:1769_DO16:C:0			
11	TAG		Local:3:I		AB:1769_DO16:I:0			
12	TAG		Local:3:O		AB:1769_DO16:O:0			
13	TAG		Local:4:C		AB:1769_DO32:C:0			
14	TAG		Local:4:I		AB:1769_DO32:I:0			
15	TAG		Local:4:O		AB:1769_DO32:O:0			
16	TAG		Local:5:C		AB:1769_DO16:C:0			
17	TAG		Local:5:I		AB:1769_DO16:I:0			
18	TAG		Local:5:O		AB:1769_DO16:O:0			
19	TAG		Local:6:C		AB:1769_IF16:C:0			
20	TAG		Local:6:I		AB:1769_IF16:I:0			
21	TAG		Local:6:O		AB:1769_IF16:O:0			
22								

①

In [Controller Organizer/Data Types/Module-Defined] of RSLogix5000, double click Data Type of the module. Data members of that type of the module will be listed in a window pops up. Copy the [Name] and [Data Type] of the Members.

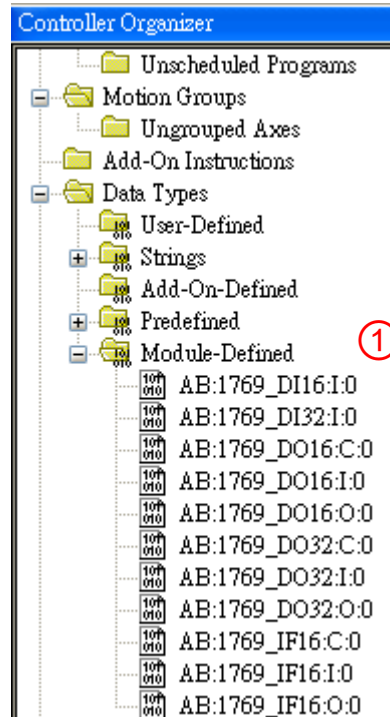

②

In [AB Data Type Editor.exe] in EB8000, right click on [Module-Defined], and then click [New Data Type...].

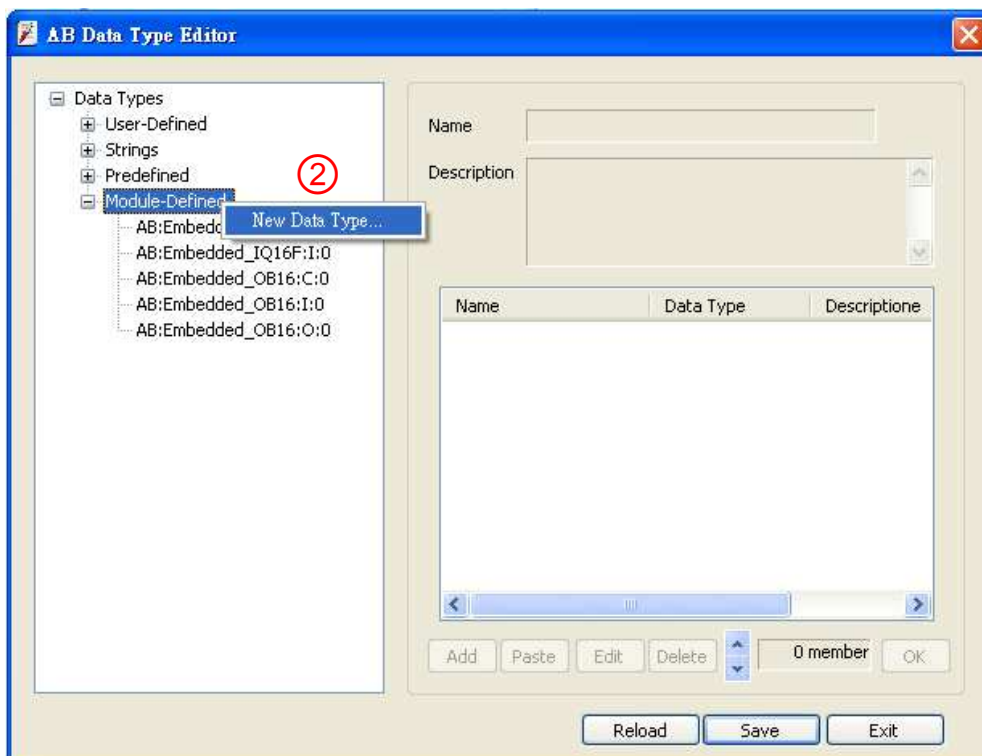

In [Name] of [New Data Type], input Module-Defined Name.

③

Click [Paste], in dialogue box press Ctrl+V to paste Name and Data Type.

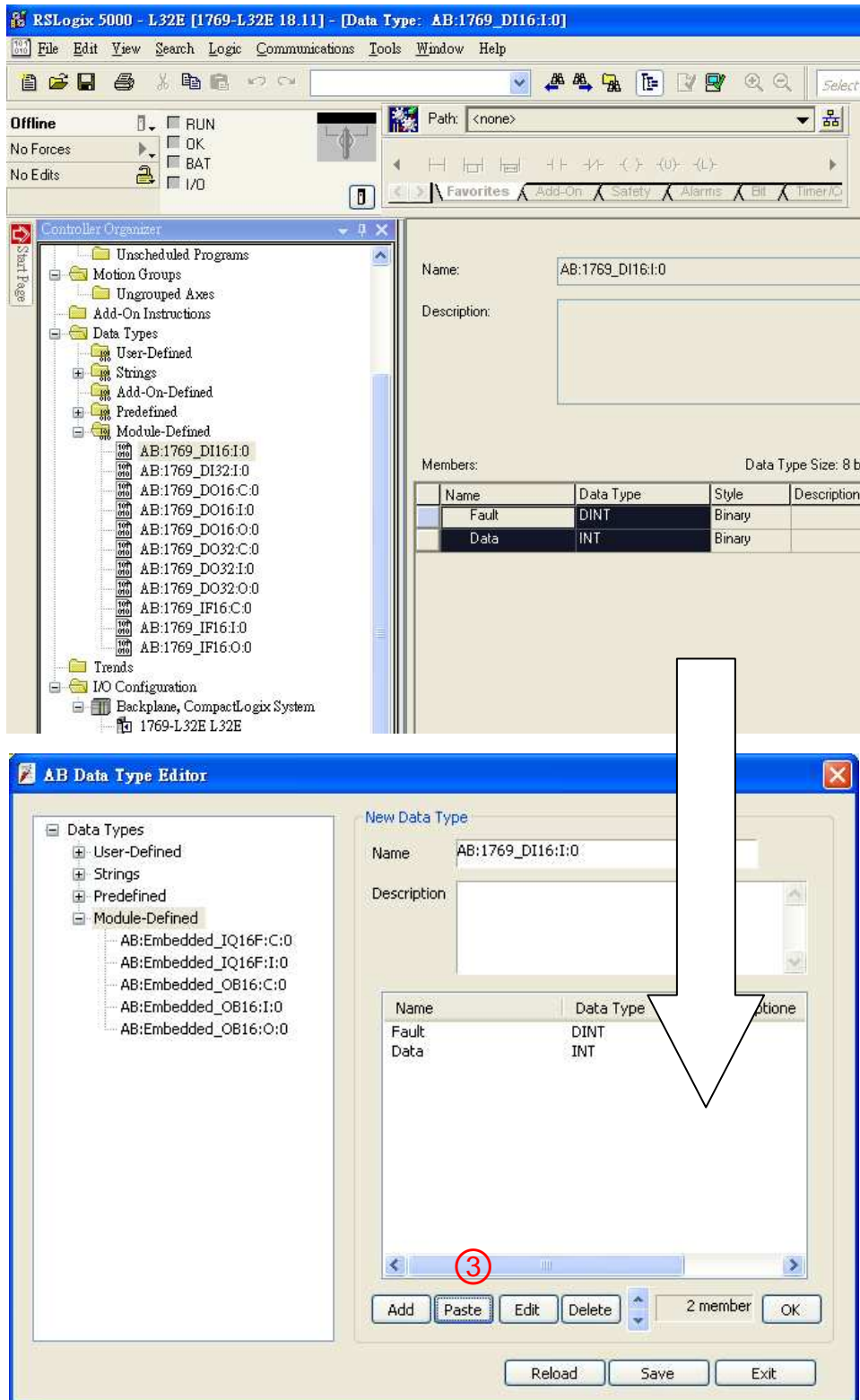

④

Select data then click [Edit], since the data of the modules can be operated by bit, here [Binary Access] should be selected, then click [OK] to return to [Data Type Editor].

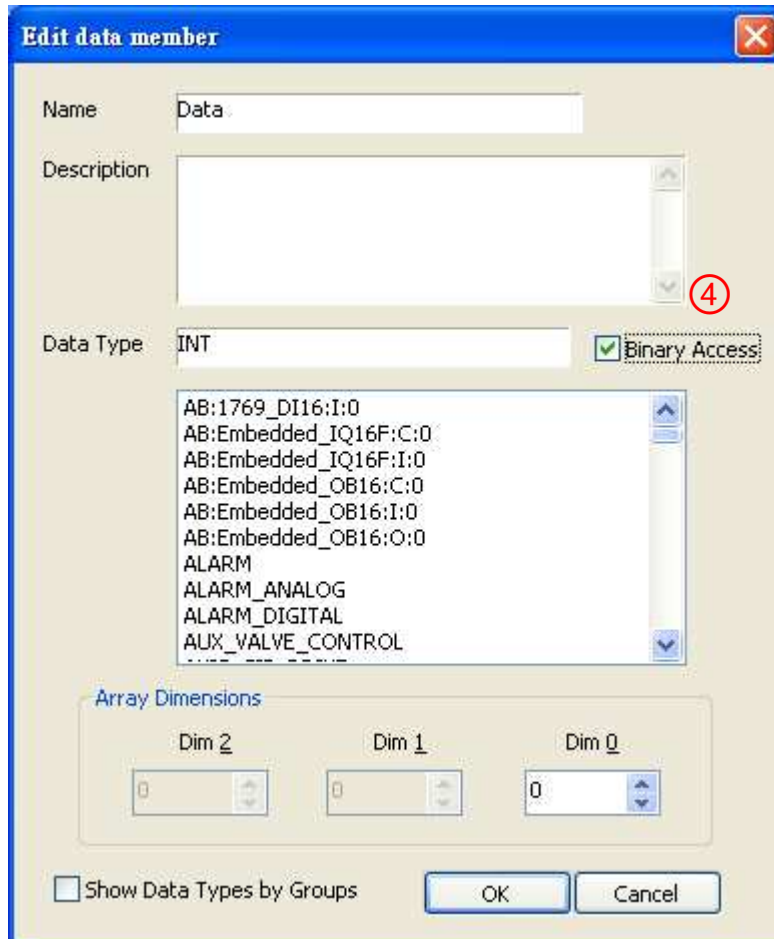

Click [OK] to finish setting.